

BAYKAL MAKINA SAN. ve TIC. A. S.

Organize San. Bölgesi
 Yeşil cadde No: 24
 Bursa
 Tel.: (224) 243 83 10
 Fax : (224) 243 12 86

Customer :
 Plant designation : APH
 Drawing No : APH.C421L00
 Project No :
 Date : 01.05.2006
 Responsible for :
 Project

TECHNICAL INFORMATION

Main Voltage : 400V 50HZ
 Control Voltage : 24VAC
 Valve Voltage : 24VDC

WORKING MODE

0 Off
 1 Adjustment Foot
 2 Single Stroke Foot

			Date	APH		APH ELECTRICAL DIAGRAM Contents				
			Editor	PC1						
			Tested	08. May. 2006						
Changes	Date	Name	Norm	Original	Sub. f.	Sub. b.	APH.C421L00		P. 1 13 P.	

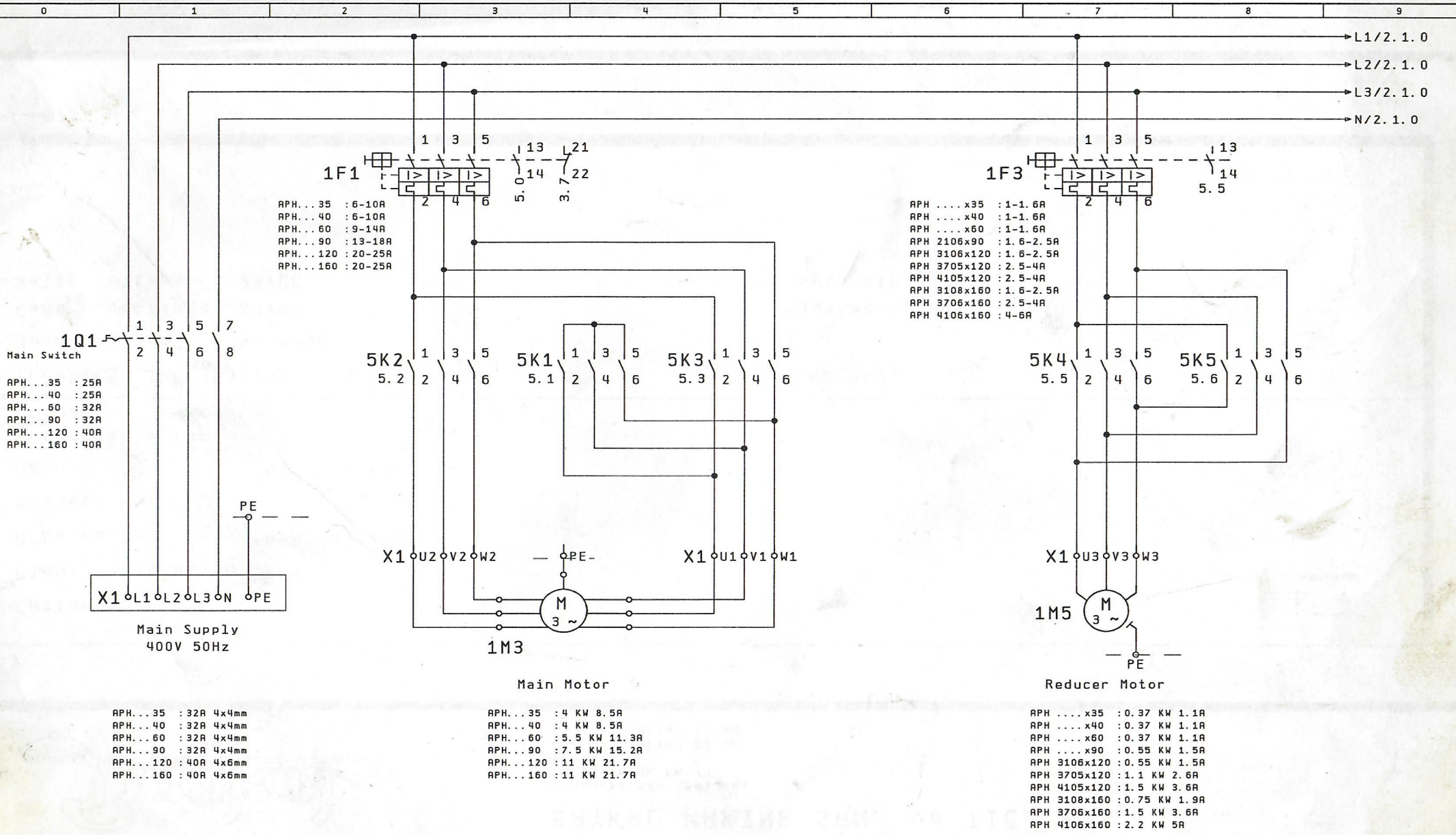

Date		APH				APH ELECTRICAL DIAGRAM			
Editor		PC1				Power Circuit			
Tested		08. May. 2006							
Changes	Date	Name	Norm	Original	Sub. f.	Sub. b.	APH. C421L00		P. 2
								13 P.	

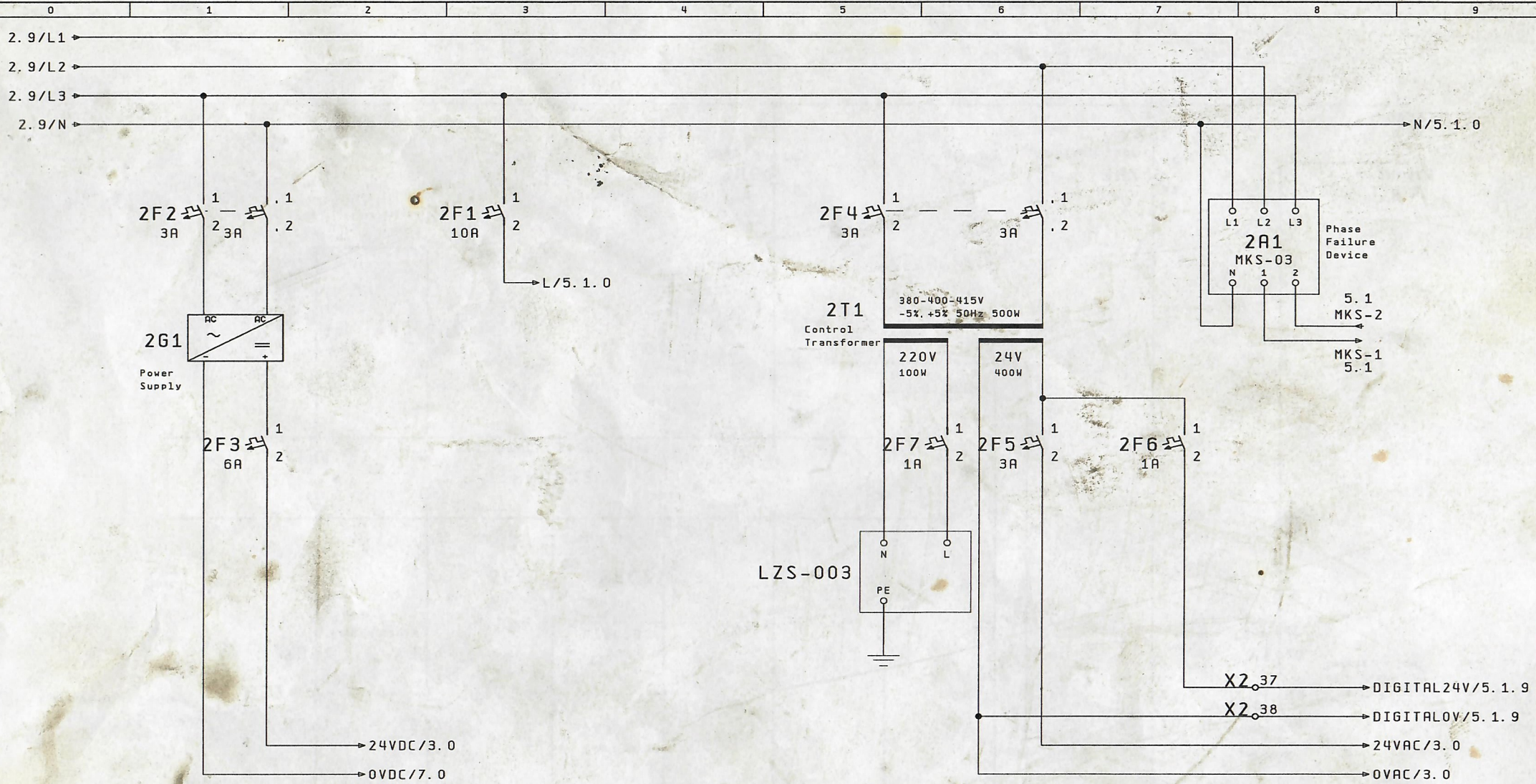

2

3

Date		APH		<i>Baykal</i>	APH ELECTRICAL DIAGRAM Power Circuit			
Editor		PC1						
Tested		08. May. 2006						
Changes	Date	Name	Norm	Original	Sub. f.	Sub. b.	APH. C421L00	P. 2. 1 13 P.

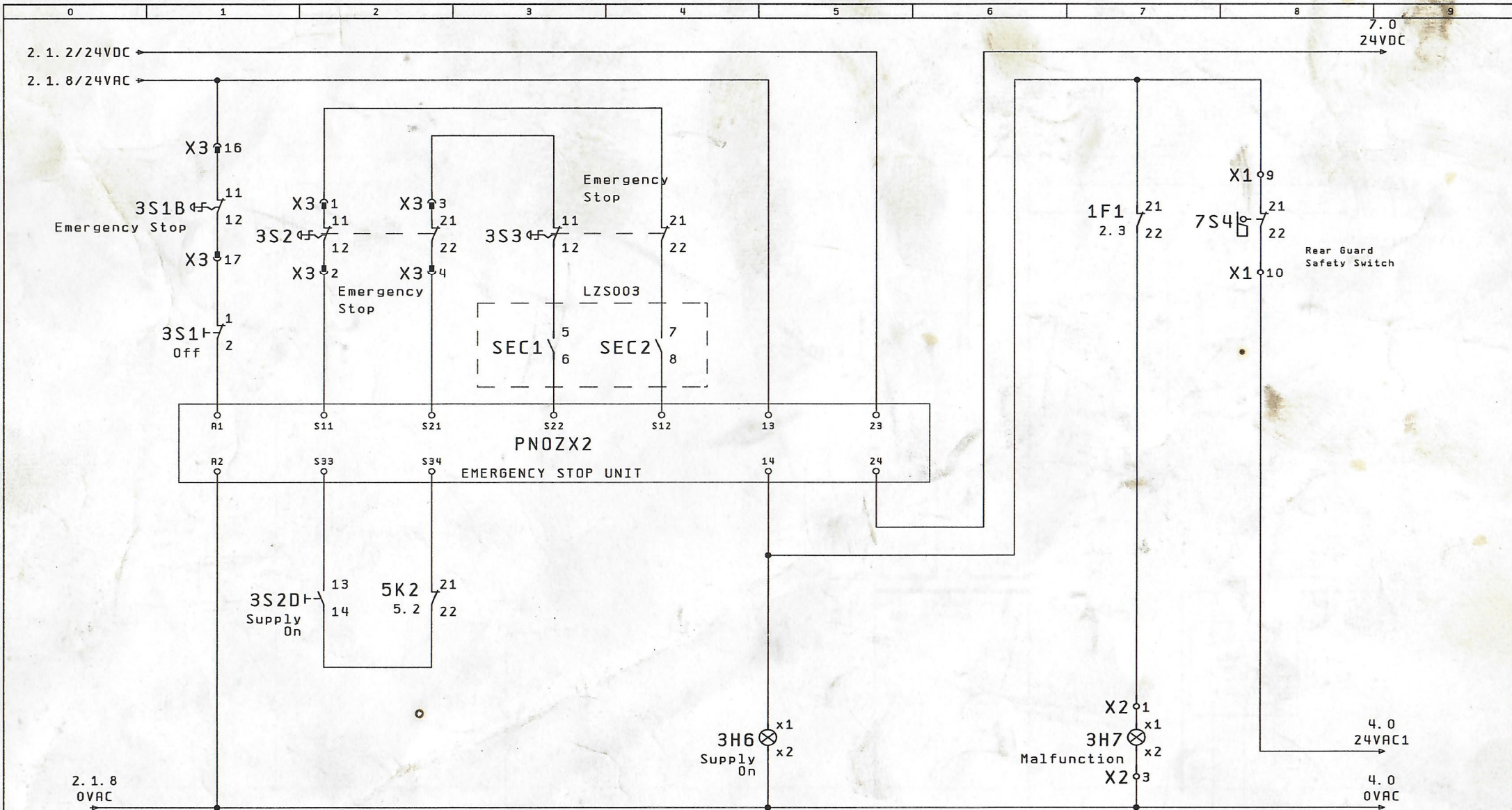

2.1

4

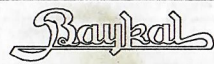
		Date	APH					
		Editor	PC1				APH ELECTRICAL DIAGRAM Emergency Stop	
		Tested	08. May. 2006					
Changes	Date	Name	Norm	Original	Sub. f.	Sub. b.	APH. C421L00	
							P. 3	13 P.

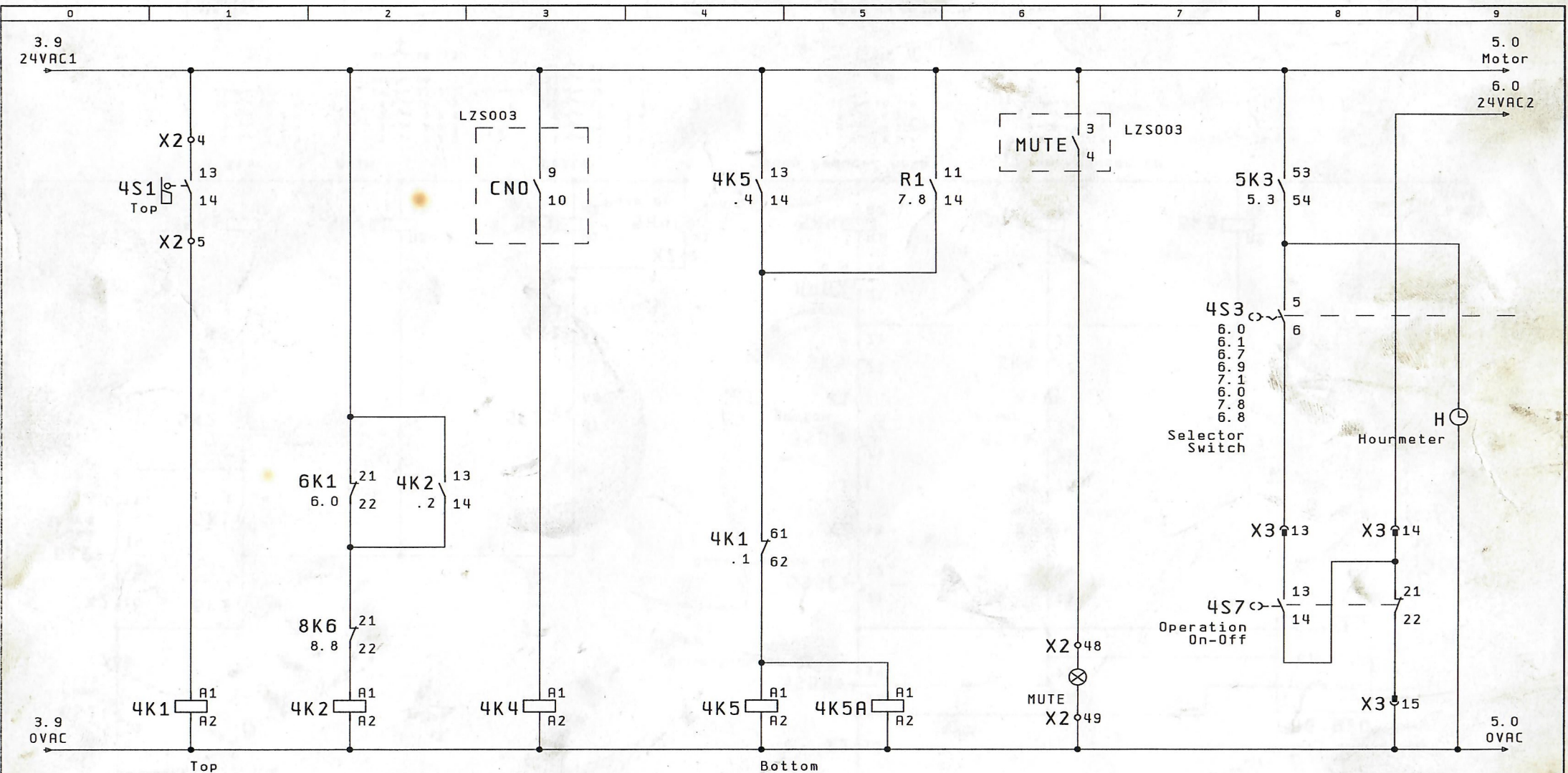

3				5				
Date	APH				APH ELECTRICAL DIAGRAM			
Editor	PC1				Control Circuit			
Tested	08. May. 2006							
Changes	Date	Name	Norm	Original	Sub. f.	Sub. b.	APH. C421L00	
							P. 4	13 P.

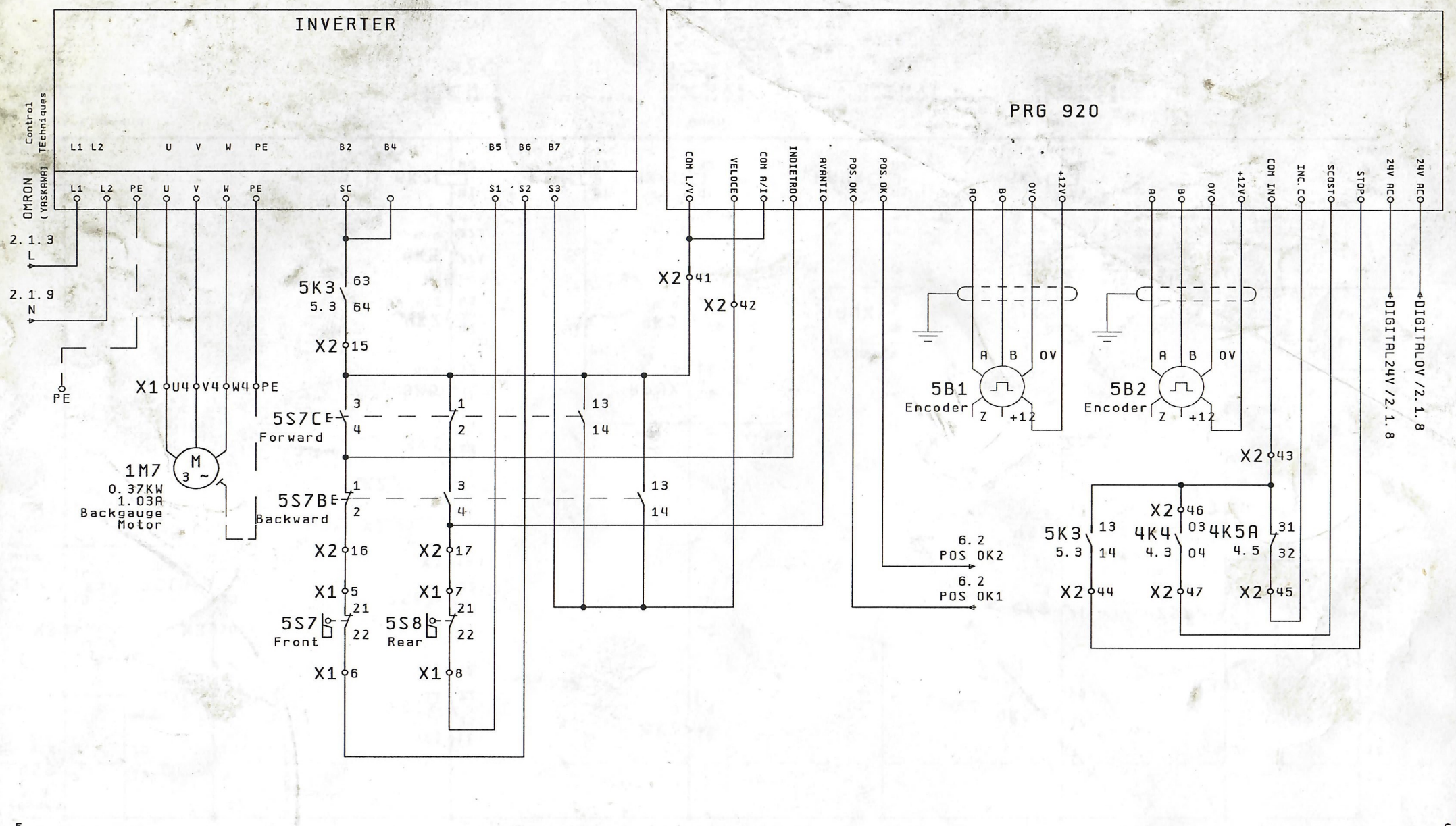

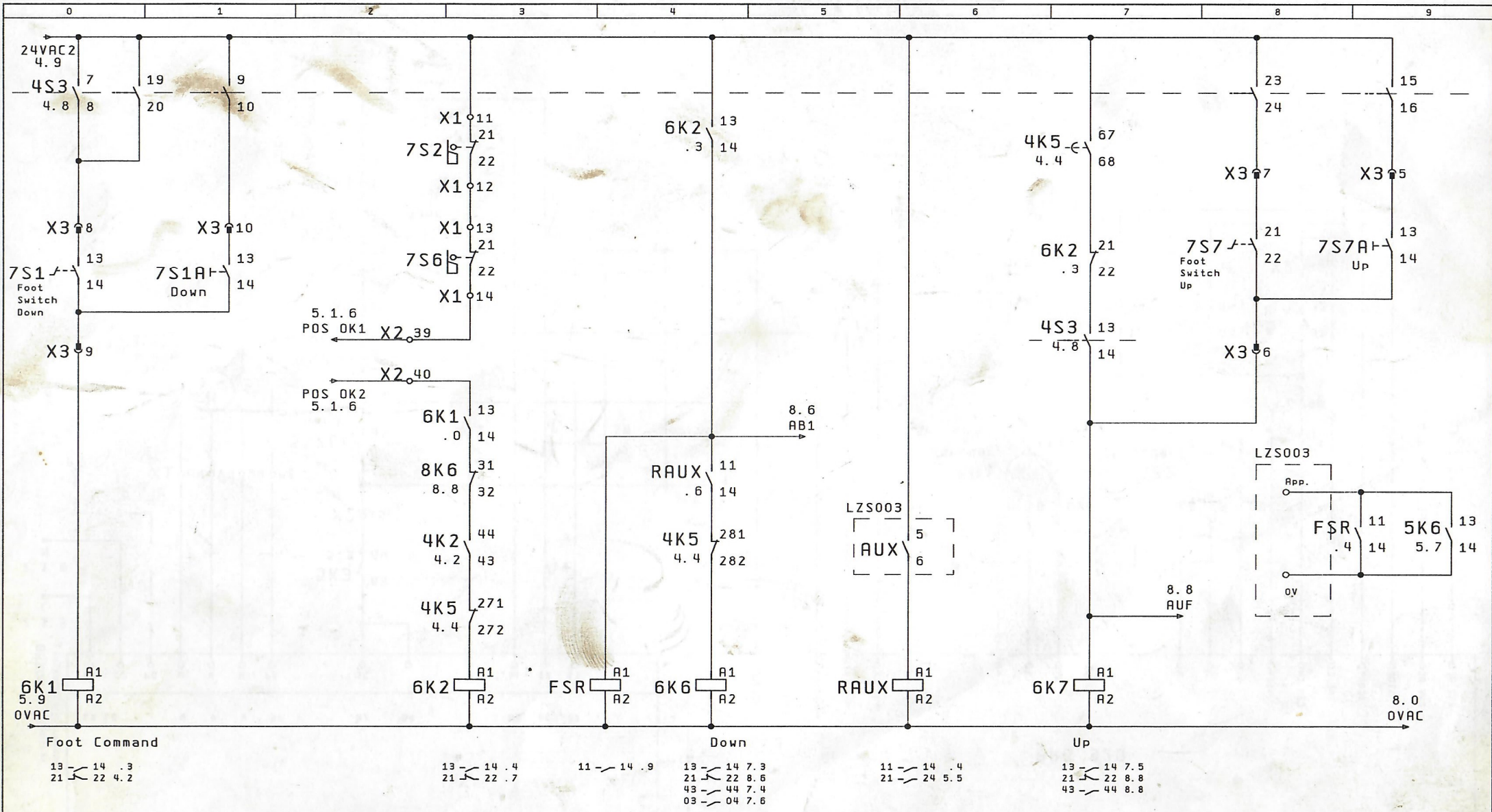

5.1				7			
Date		APH		APH ELECTRICAL DIAGRAM			
Editor	PC1			Control Circuit			
Tested	08. May. 2006						
Changes	Date	Name	Norm	Original	Sub. f.	Sub. b.	
						APH. C421L00	
						P. 6 13 P.	



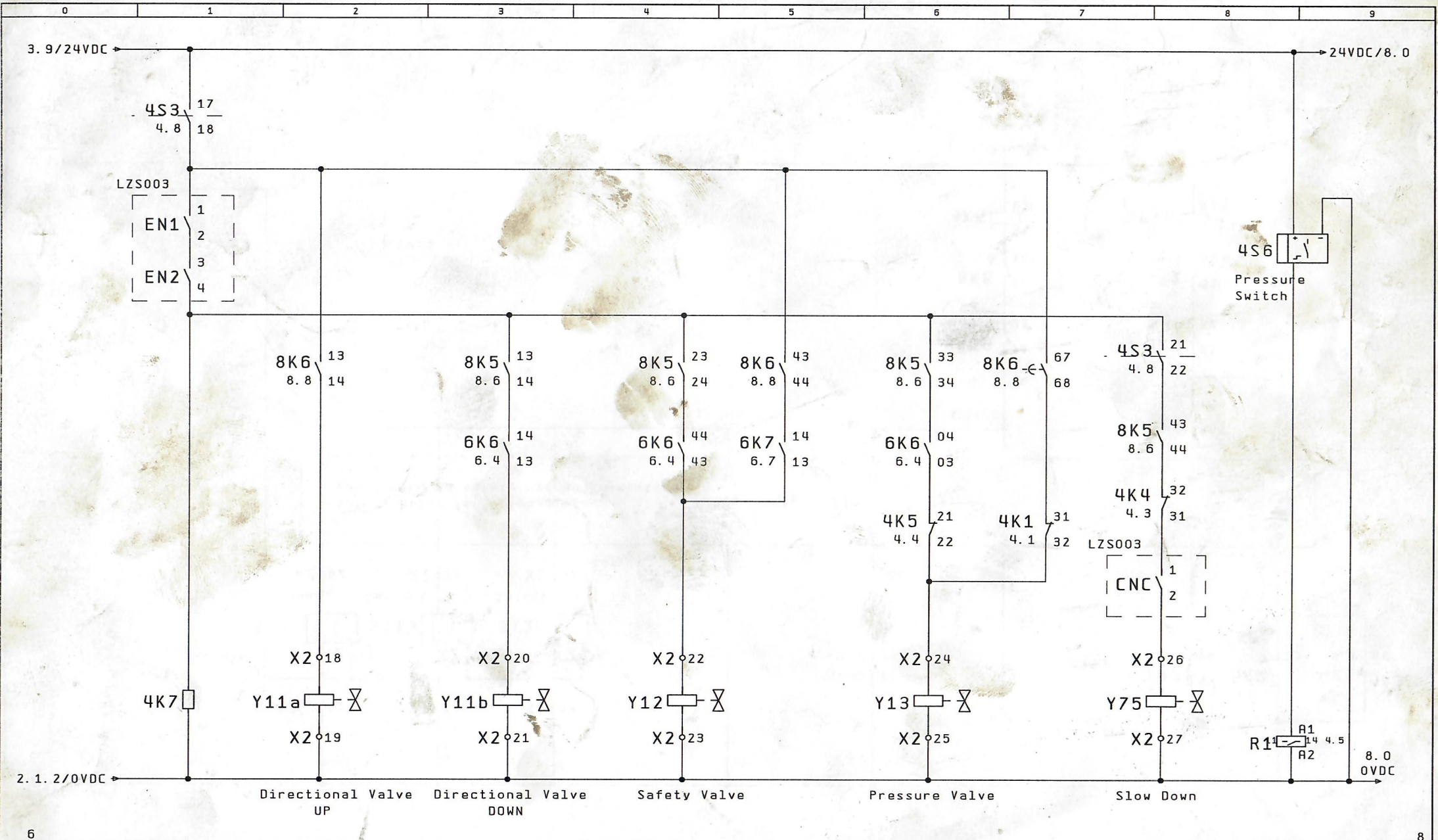

6														8			
Date		APH				APH ELECTRICAL DIAGRAM											
Editor	PC1					Valve Control											
Tested	08. May. 2006																
Changes	Date	Name	Norm	Original	Sub. f.	Sub. b.			APH. C421L00				P. 7		13 P.		

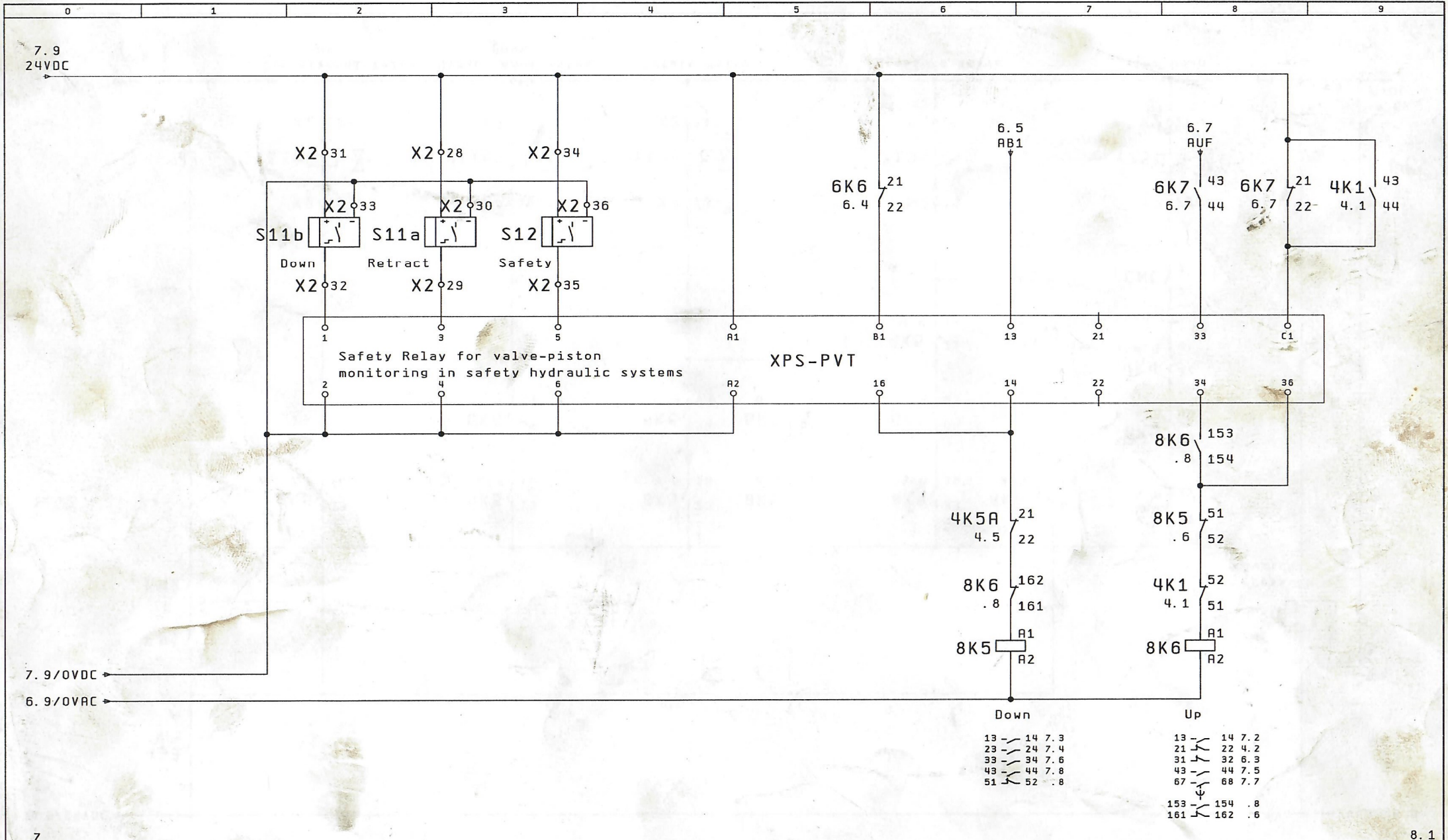

				Date		APH					
				Editor		PC1					
				Tested		08. May. 2006					
Changes	Date	Name	Norm	Original	Sub. f.	Sub. b.				APH. C421L00	P. 8
										13 P.	8.1



APH ELECTRICAL DIAGRAM
Valve Control

APH. C421L00

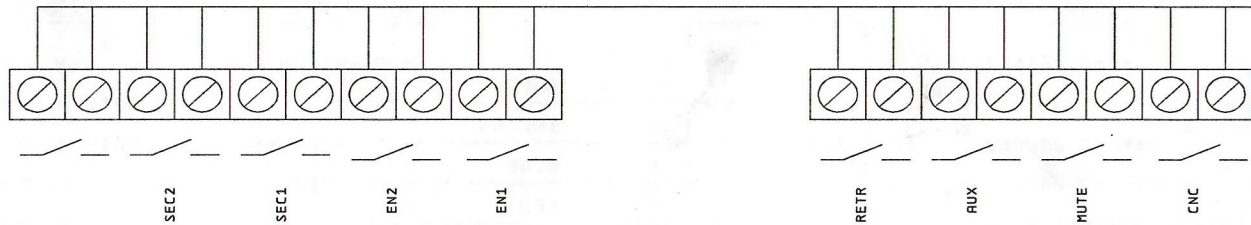

SHLD 0V MSWS RSNS MSNS FSNS +5V

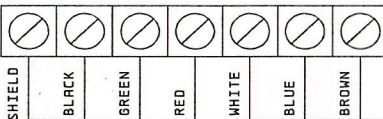

SHLD 0V LSRB LSRA +5V

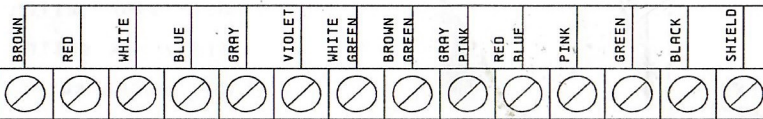
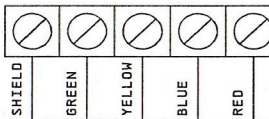

+5V FCLR MCLR RCLR CLR NOTCLR TSTLED MUTESTSWI LOCKSWI MUTESWI MUTE+ MUTE- 0V SHLD

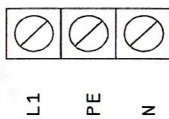
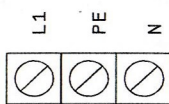
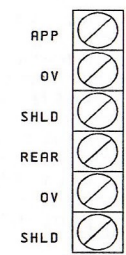
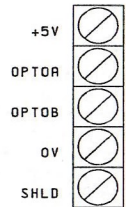

		Date		APH					
		Editor		PC1					
		Tested		08. May. 2006					
Changes	Date	Name	Norm	Original	Sub. f.	Sub. b.	APH. C421L00		P. 8. 1
									13 P.



APH ELECTRICAL DIAGRAM
LZS003

RECEIVER

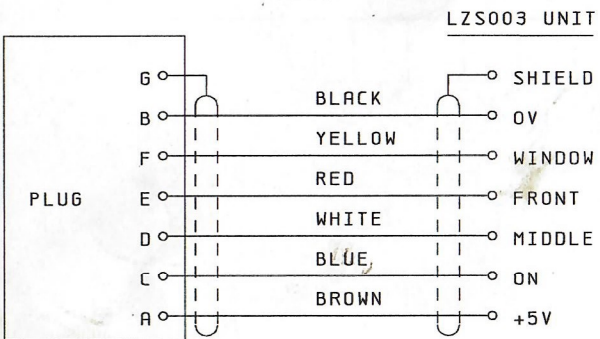

TRANSMITTER

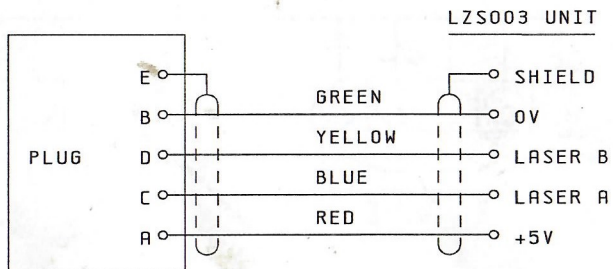

LZS003 UNIT

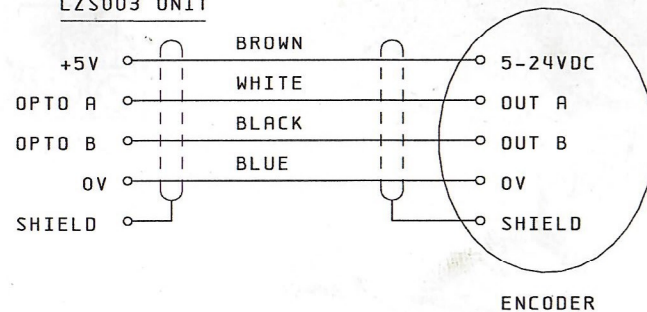

PANEL

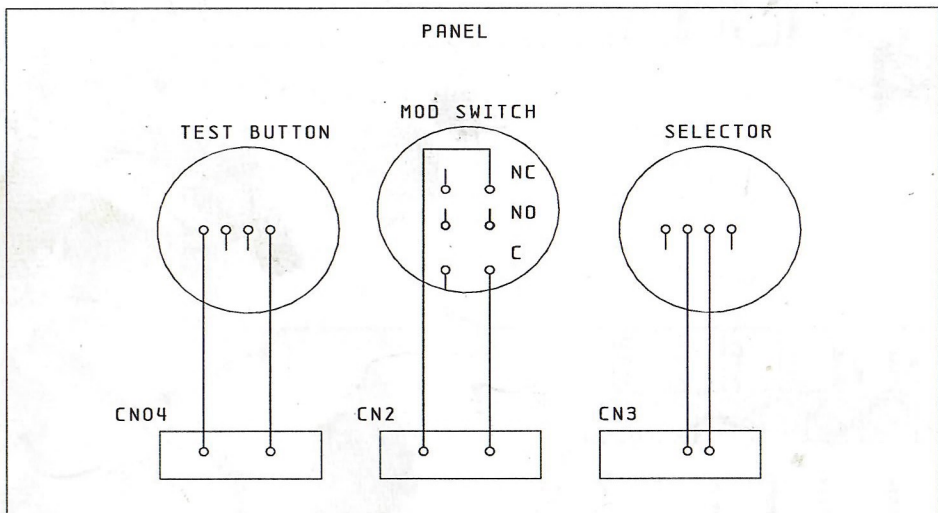

LZS003 UNIT

OPERATOR PANEL

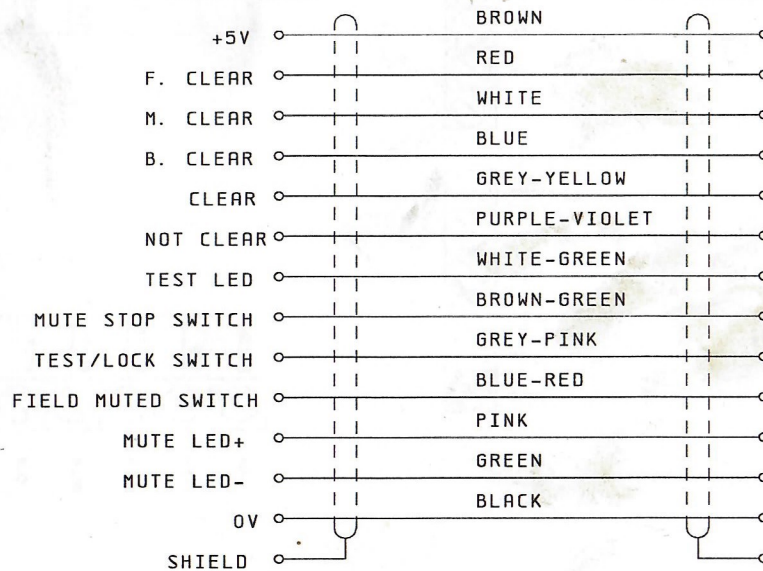

Date	
Editor	PC1
Tested	08. May. 2006

APH

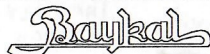

APH ELECTRICAL DIAGRAM
LZS003

Changes	Date	Name	Norm
---------	------	------	------

Original

Sub. f.

Sub. b.

APH. C421L00

terminal diagram

WUPK007E 01.03.1994

terminal strip designation X1

Destination	Conn.	No.	Jumper	PLC	Destination	Conn.	Page/path	Path designation / functions
		L1			1Q1	2	2.1	Main Supply
		L2			1Q1	4	2.1	=
		L3			1Q1	6	2.1	=
		N			1Q1	8	2.1	=
		PE			PE		2.1	=
1M3		U2			5K2	2	2.2	Main Motor
1M3		V2			5K2	4	2.3	=
1M3		W2			5K2	6	2.3	=
1M3		PE					2.3	=
1M3		U1			5K3	2	2.4	=
1M3		V1			5K3	4	2.5	=
1M3		W1			5K3	6	2.5	=
1M5		U3			5K4	2	2.7	Reducer Motor
1M5		V3			5K4	4	2.7	=
1M5		W3			5K4	6	2.7	=
1M7		U4		U	INVERTER	U	5.1.1	Backgauge Motor
1M7		V4		V	INVERTER	V	5.1.1	=
1M7		W4		W	INVERTER	W	5.1.1	=
1M7		PE		PE	INVERTER	PE	5.1.1	PE
5S5	21	1			X2	13	5.5	Bottom Limit Switch
5S5	22	2			5K5	22	5.5	=
5S6	21	3			X2	14	5.6	Top Limit Switch
5S6	22	4			5K4	22	5.6	=
5S7	21	5			X2	16	5.1.2	Front Limit Switch
INVERTER	S2	6		S2	5S7	22	5.1.2	=

8.2

10

Date	08. May. 2006	APH		X1	-	+		
Editor	AAA							
Tested	08. May. 2006							
Changes	Date	Name	Norm	Original	Sub. f.	Sub. b.	APH. C421L00	P. 9 13 P.

terminal diagram

WUPK007E 01.03.1994

terminal strip designation X2

Destination	Conn.	No.	Jumper	PLC	Destination	Conn.	Page/path	Path designation / functions
3H7	x1	1			1F1	22	3.7	Malfunction Lamp
5H4	x1	2			5K3	A1	5.4	Pump On
3H7	x2	3			3H6	x2	3.7	Malfunction Lamp
4S1	13	4			X1	10	4.1	Top Sw.
4S1	14	5			4K1	A1	4.1	=
6S1	21	8		1	2A1	1	5.0	Pump Stop
6S1	22	9	•		5K2	13	5.0	=
6S2	13	10	•				5.0	Pump Start
6S2	14	11			5K1	14	5.0	=
5S5B	13	12			1F3	14	5.5	Beam Reducer Down Button
5S5C	22	13			X1	1	5.5	Beam Reducer Up Button
5S5C	14	14			X1	3	5.6	=
5S7C	3	15			5K3	64	5.1.2	Forward Button
X1	5	16			5S7B	2	5.1.2	Backward Button
X1	7	17			5S7B	4	5.1.3	=
Y11a		18			8K6	14	7.2	Directional Valve UP
Y11a		19	•		4K7		7.2	=
Y11b		20	•		6K6	13	7.3	Directional Valve DOWN
Y11b		21	•				7.3	=
Y12		22	•		6K6	43	7.4	Safety Valve
Y12		23	•				7.4	=
Y13		24	•		4K5	22	7.6	Pressure Valve
Y13		25	•				7.6	=
Y75		26	•		CNC	2	7.8	Slow Speed
Y75		27	•		R1	A2	7.8	=

10

12

Date	08. May. 2006	APH		X2				
Editor	AAA							
Tested	08. May. 2006							
Changes	Date	Name	Norm	Original	Sub. f.	Sub. b.		
							APH. C421L00	P. 11 13 P.

