

MITSUBISHI SEMICONDUCTORS POWER MODULES MOS

MAIN APPLICATIONS FOR POWER MODULES

2.0 Main Applications for Power Modules

Power modules are now commonly used in both converter and inverter circuits. As shown in the application chart in Figure 2.1, the main application of the IGBT is for use as a switching component in inverter circuits which are used in both power supply and motor drive applications. Table 2.1 shows the main markets IGBT modules have been designed to serve, the trends of the application, the requirements of the power device serving the application, and the type of IGBT or Intelligent Power Module (IPM) available to satisfy the trend requirements.

Figure 2.1 Main Applications of the IGBT

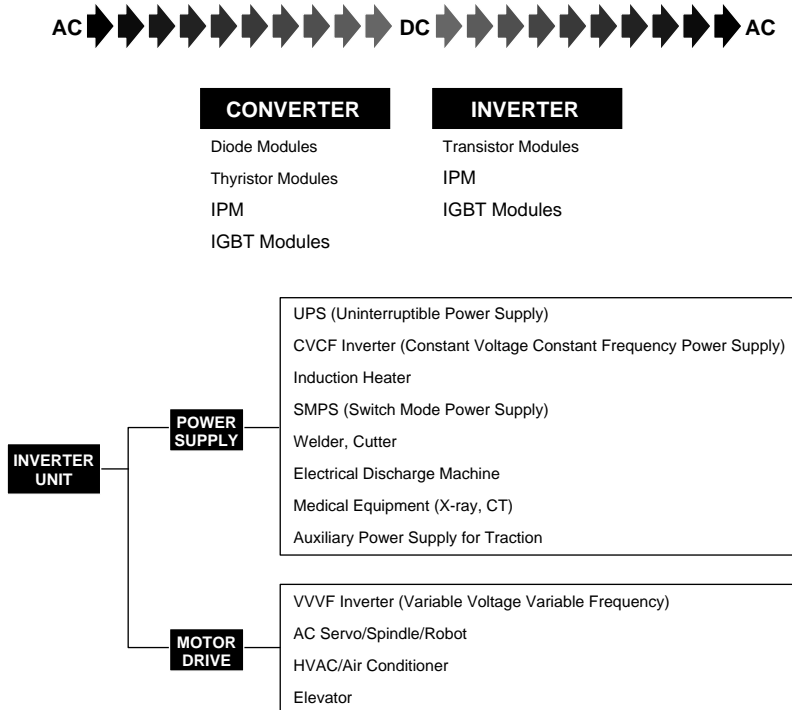

Table 2.1 Market Trend

Main Markets	Trend of Application	Requirements to Power Devices	New Power Devices
Inverter	Low Noise Oriented	High Frequency	High Frequency IGBT Module
UPS Elevator	Small-Sized	Small Drive-Power	High Frequency IPM
Air Conditioner	Small-Sized Low Cost	Integrated	IPM for Air Conditioner Use High Frequency IGBT Module
AC Servo	High Accuracy Automatic Assembly	Reduction of Dead-Time	IGBT Module (Low $V_{CE(sat)}$) IPM (Low $V_{CE(sat)}$)

MAIN APPLICATIONS FOR POWER MODULES

2.1 Basic Circuit Examples of Main Power Module Applications

VVVF INVERTER (PWM)

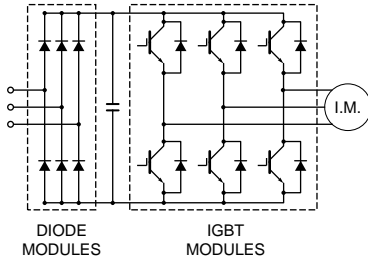

VVVF INVERTER (PAM)

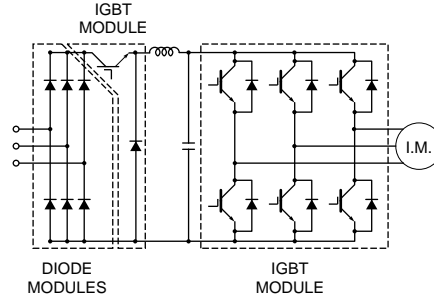

CVCF INVERTER (UPS)

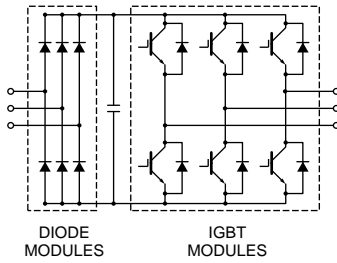

LOW POWER CVCF INVERTER (UPS)

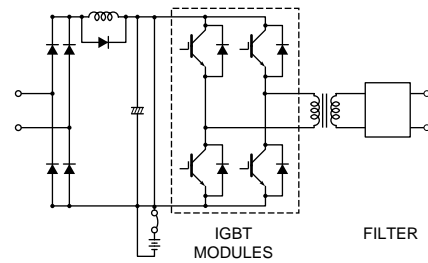

DC SERVO (NC, ROBOTS)

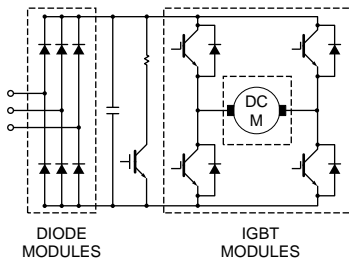

DC CHOPPER

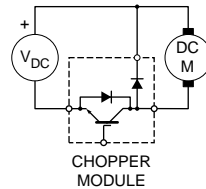

WELDER

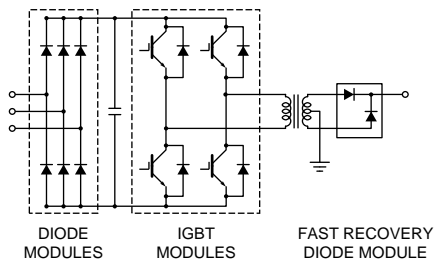

INDUCTION HEATER FOR COOKING

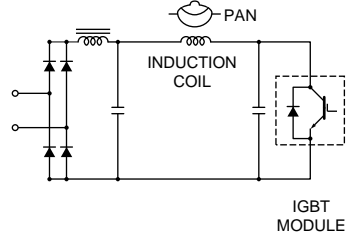

MAIN APPLICATIONS FOR POWER MODULES

2.2 Applications of IPM/IGBT Module to AC Motor Controls (VVF Inverter, Servo Amps, etc.)

Figure 2.2

VVVF INVERTER (PWM)

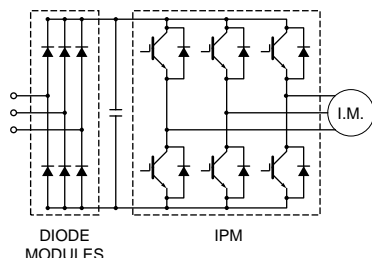

■ AC 220V Line

Motor Rating kW	IGBT Module		Diode Module	IPM		Diode Module
	H series	U series		3rd. Gen. IPM	V series	
0.4	CM15TF-12H		RM10TA-H	PM10CSJ060		RM10TA-H
0.75	CM15TF-12H		RM10TA-H	PM15CSJ060		RM10TA-H
1.1	CM15TF-12H		RM10TA-H	PM15CSJ060		RM10TA-H
1.5	CM20TF-12H		RM10TA-H	PM20CSJ060		RM10TA-H
2.2	CM30TF-12H		RM15TA-H	PM30CSJ060 PM30RSF060		RM15TA-H
3.7	CM50TF-12H		RM20TPM-H	PM50RSA060 PM50RSK060		RM20TPM-H
5.5	CM75TF-12H	CM75TU-12H CM75DU-12H × 3	RM30TB-H	PM75RSA060 PM75RSK060	PM75RVA060	RM30TPM-H*
7.5	CM75TF-12H	CM100TU-12H CM100DU-12H × 3	RM30TA-H	PM75RSA060 PM75RSK060	PM75RVA060	RM30TPM-H*
11	CM100TF-12H CM100DY-12H × 3	CM100TU-12H CM100DU-12H × 3	RM50TC-H RM60DZ-H × 3	PM100CSA060 PM100RSA060	PM100CVA060	RM30TPM-H
15	CM150TF-12H CM150DY-12H × 3	CM150TU-12H CM150DU-12H × 3	RM75TC-H RM60DZ-H × 3	PM150CSA060 PM150RSA060	PM150CVA060	RM75TPM-H
18.5	CM200DY-12H	CM200TU-12H CM200DU-12H × 3	RM60DZ-H × 3	PM150CSA060 PM150RSA060	PM150CVA060	RM75TPM-H
22	CM200DY-12H × 3	CM300DU-12H × 3	RM100DZ-H × 3	PM200CSA060 PM200RSA060	PM200CVA060	RM100DZ-H × 3 RM75TPM-H*
30	CM300DY-12H × 3	CM300DU-12H × 3	RM100DZ-H × 3	PM300CSA060 PM300DSA060 × 3	PM300CVA060	RM100DZ-H × 3
37	CM400DY-12H × 3	CM400DU-12H × 3	RM150DZ-H × 3	PM400DSA060 × 3	PM400DVA060 × 3	RM150DZ-H × 3
45	CM400DY-12H × 3	CM600HU-12H × 6	RM150DZ-H × 3	PM400DSA060 × 3	PM400DVA060 × 3	RM150DZ-H × 3
55	CM600HA-12H × 6	CM600HU-12H × 6	RM150DZ-H × 3	PM600DSA060 × 3	PM600DVA060 × 3	RM150DZ-H × 3
75				PM800HSA060 × 6		RM250DZ-H × 3

* - Same height as IPM

MAIN APPLICATIONS FOR POWER MODULES

■AC440V Line

Motor Rating kW	IGBT Module		Diode Module	IPM		Diode Module
	H series	U series		3rd. Gen. IPM	V series	
0.4	CM15TF-24H		RM10TA-2H	PM10CZF120 PM10RSH120		RM10TA-2H
0.75	CM15TF-24H		RM10TA-2H	PM10CZF120 PM10RSH120		RM10TA-2H
1.5	CM15TF-24H		RM10TA-2H	PM10CZF120 PM10RSH120		RM10TA-2H
2.2	CM20TF-24H		RM10TA-2H	PM15CZF120 PM15RSH120		RM10TA-2H
3.7	CM30TF-24H		RM15TA-2H	PM25RSB120 PM25RSK120		RM15TA-2H
5.5	CM50TF-24H	CM50TU-24H CM50DU-24H × 3	RM15TA-2H	PM50RSA120	PM50RVA120	RM20TPM-2H
7.5	CM50TF-24H	CM50TU-24H CM50DU-24H × 3	RM20TA-2H	PM50RSA120	PM50RVA120	RM20TPM-2H
11	CM75TF-24H	CM75TU-24H CM75DU-24H × 3	RM50TC-2H	PM75CSA120 PM75DSA120	PM75CVA120	RM30DZ-2H × 3 RM75TPM-2H
15	CM100TF-24H	CM100TU-24H CM100DU-24H × 3	RM30DZ-2H × 3	PM75CSA120 PM75DSA120	PM75CVA120	RM30DZ-2H × 3 RM75TPM-2H
18.5	CM150DY-24H × 3	CM150DU-24H × 3	RM60DZ-2H × 3	PM100CSA120 PM100DSA120 × 3	PM100CVA120	RM30DZ-2H × 3 RM75TPM-2H
22	CM150DY-24H × 3	CM150DU-24H × 3	RM60DZ-2H × 3 RM50TC-2H	PM100CSA120 PM100DSA120 × 3	PM100CVA120	RM30DZ-2H × 3 RM75TPM-2H
30	CM200DY-24H × 3	CM200DU-24H × 3	RM60DZ-2H × 3	PM150CSA120 PM150DSA120 × 3	PM150CVA120	RM60DZ-2H × 3
37	CM200DY-24H × 3	CM200DU-24H × 3	RM60DZ-2H × 3	PM200DSA120 × 3	PM200DVA120 × 3	RM60DZ-2H × 3
45	CM300DY-24H × 3	CM300DU-24H × 3	RM100DZ-2H × 3	PM200DSA120 × 3	PM200DVA120 × 3	RM100DZ-2H × 3
55	CM300DY-24H × 3	CM300DU-24H × 3	RM150DZ-2H × 3	PM300DSA120 × 3	PM300DVA120 × 3	RM150DZ-2H × 3
75	CM400HA-24H × 6	CM400HU-24H × 6	RM150DZ-2H × 3	PM400HSA120 × 6		RM150DZ-2H × 3
110	CM600HA-24H × 6	CM600HU-24H × 6	RM250DZ-2H × 3	PM600HSA120 × 6		RM250DZ-2H × 3