

STROMBERG FINLAND

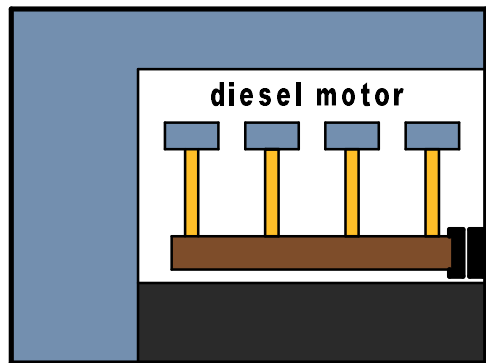

1070KW / 1236A
750RPM

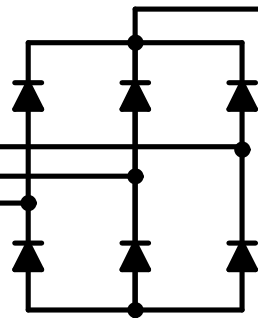
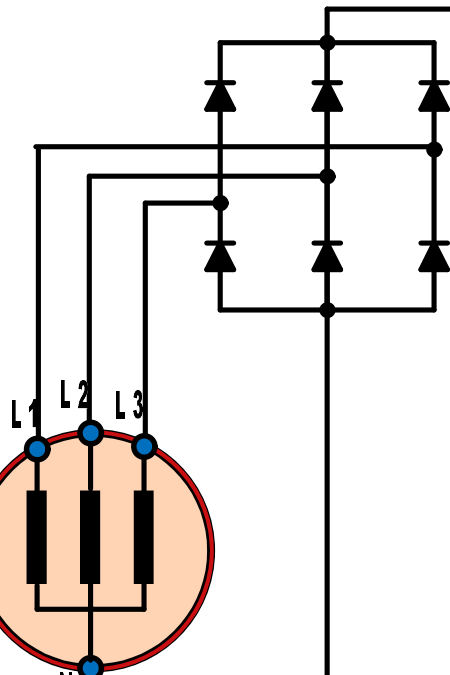

700KW / 1250A / 240RPM

DC MOTOR

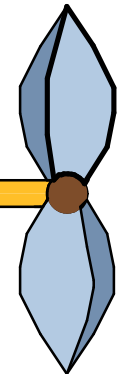
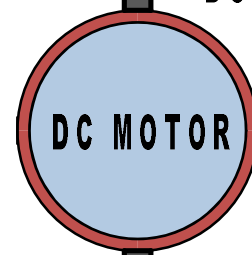

TO VOLTAGE / SPEED CONTROL
OF THE DC MOTOR UNIT

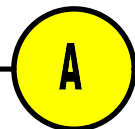

0 UP TO 47A FIELD
0 TO 136V

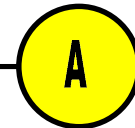

TO CONSTANT
CURRENT UNIT

FIELD 47A

SYNCHRO GENERATOR

DC MOTOR

