



**SPRINT** | **ELECTRIC**

**PL / PLX**  
**Digital DC Drive**  
**Product manual**





NOTE. These instructions do not purport to cover all details or variations in equipment, or to provide for every possible contingency to be met in connection with installation, operation, or maintenance. Should further information be desired or should particular problems arise which are not covered sufficiently for the purchaser's purposes, the matter should be referred to the local Supplier sales office. The contents of this instruction manual shall not become part of or modify any prior or existing agreement, commitment, or relationship. The sales contract contains the entire obligation of Sprint Electric Ltd. The warranty contained in the contract between the parties is the sole warranty of Sprint Electric Ltd. Any statements contained herein do not create new warranties or modify the existing warranty.

**IMPORTANT MESSAGE** This is a version 5.14 manual. Version 5.14 and above software has all the functions described. See 5.1.7 Finding the software version number of the unit.

**DO YOU NEED HELP?** See 14.13 What to do in the event of a problem.

There are 3 other PL/X manuals. APPLICATION BLOCKS, SERIAL COMMS and STACK DRIVER manuals. All the latest version manuals are also available to download from the internet at [www.sprint-electric.com](http://www.sprint-electric.com)

## 1 Table of contents

<b>1</b>	<b>Table of contents</b> .....	<b>3</b>
<b>2</b>	<b>Warnings</b> .....	<b>13</b>
2.1	General Warnings .....	13
2.2	Warnings and Instructions .....	14
2.3	General Risks .....	15
2.4	Summary of further WARNINGS .....	16
<b>3</b>	<b>Introduction and Technical Data</b> .....	<b>19</b>
3.1	Introduction .....	20
3.2	How do they work? .....	20
3.2.1	Useful things to know about the PL/X .....	21
3.2.2	Tips for using the manual .....	21
3.3	General Technical Data .....	22
3.3.1	Regenerative stopping with PL models .....	22
3.3.2	Supply voltages required for all models .....	22
3.3.3	Control terminals electrical specification .....	24
3.4	Control terminals overview. ....	25
3.4.1	General requirements .....	25
3.4.2	Digital inputs and outputs .....	25
3.4.2.1	Encoder inputs .....	26
3.4.2.2	Digital outputs .....	26
3.4.3	Analogue inputs .....	26
3.4.4	Analogue tachogenerator input .....	27
3.4.5	Signal test pins .....	27
3.5	Control terminal default functions .....	27
3.5.1	Run, Jog, Start, Cstop .....	29
3.5.2	Summary of default terminal functions .....	31
3.6	Supply loss shutdown .....	32
<b>4</b>	<b>Basic application</b> .....	<b>33</b>
4.1	Basic speed or torque control .....	34
4.2	Main Contactor operation .....	35
4.2.1	Contactor control questions and answers .....	35
4.3	Main contactor wiring options .....	37
4.3.1	Main contactor isolating AC stack supply .....	37

4.3.2	Main contactor isolating AC stack and auxiliary supplies .....	37
4.3.3	Main contactor isolating DC armature .....	38
4.3.4	Using pushbuttons for simple STOP / START (Coast to stop) .....	39
4.3.5	Using pushbuttons for STOP / START (With ramp to stop, jog and slack take up) .....	40
4.4	ESSENTIAL pre-start checks .....	41
4.4.1	POWER ENGINEERING .....	41
4.4.2	MECHANICAL ENGINEERING .....	41
4.5	CONTROL ENGINEERING COMMISSIONING PROCEDURES .....	42
4.5.1	Quick start calibration .....	42
4.5.2	Quick start calibration step by step .....	43
4.5.3	Quick start current loop AUTOTUNE .....	43
4.5.4	PASSIVE MOTOR defaults / Using passive motor menu for small test motors .....	44
<b>5</b>	<b>Menu tree structure .....</b>	<b>45</b>
5.1	Key functions .....	46
5.1.1	Incrementing and decrementing parameter values. ....	47
5.1.2	PARAMETER SAVE .....	47
5.1.3	Restoring the drive parameters to the default condition .....	47
5.1.4	Branch hopping between monitor windows .....	47
5.1.5	Power up windows .....	47
5.1.6	Default % DIAGNOSTIC summary windows .....	48
5.1.7	Finding the software version number of the unit. ....	48
5.2	ENTRY MENU .....	48
5.2.1	Full menu diagram (Change parameters) .....	49
5.2.2	Full menu diagram (Change parameters continued) .....	50
5.2.3	Full menu diagram (Diagnostics) .....	51
5.2.4	Full menu diagram (Motor drive alarms, serial links and display functions) .....	52
5.2.5	Full menu diagram (Application blocks and configuration) .....	53
5.2.6	Full menu diagram (Configuration continued) .....	54
5.2.7	Full menu diagram (Block OP and Fieldbus configs, Drive personality and Conflict Help) .....	55
5.3	Archiving PL/X recipes .....	56
<b>6</b>	<b>CHANGE PARAMETERS .....</b>	<b>57</b>
6.1	CHANGE PARAMETERS / CALIBRATION .....	59
6.1.1	CALIBRATION / Block diagram .....	60
6.1.2	CALIBRATION / Rated armature amps PIN 2 QUICK START .....	60
6.1.3	CALIBRATION / Current limit (%) PIN 3 QUICK START .....	61
6.1.4	CALIBRATION / Rated field amps PIN 4 QUICK START .....	61
6.1.5	CALIBRATION / Base rated motor rpm PIN 5 QUICK START .....	62
6.1.6	CALIBRATION / Desired max rpm PIN 6 QUICK START .....	62
6.1.7	CALIBRATION / Zero speed offset PIN 7 .....	62
6.1.8	CALIBRATION / Max tachometer volts PIN 8 .....	63
6.1.9	CALIBRATION / Speed feedback type PIN 9 QUICK START .....	64
6.1.10	CALIBRATION / ENCODER SCALING .....	65
6.1.10.1	ENCODER SCALING / Quadrature enable PIN 10 .....	66
6.1.10.2	ENCODER SCALING / Encoder lines PIN 11 .....	67
6.1.10.3	ENCODER SCALING / Motor / encoder speed ratio PIN 12 .....	67
6.1.10.4	ENCODER SCALING / Encoder sign PIN 13 .....	67
6.1.11	CALIBRATION / IR compensation PIN 14 .....	68
6.1.12	CALIBRATION / Field current feedback trim PIN 15 .....	68
6.1.13	CALIBRATION / Armature volts trim PIN 16 .....	68
6.1.14	CALIBRATION / Analog tachometer trim PIN 17 .....	69
6.1.15	CALIBRATION / Rated armature volts PIN 18 QUICK START .....	69
6.1.16	CALIBRATION / EL1/2/3 rated AC volts PIN 19 QUICK START .....	69
6.1.17	CALIBRATION / Motor 1 or 2 select PIN 20 .....	70
6.2	CHANGE PARAMETERS / RUN MODE RAMPS .....	71
6.2.1	RUN MODE RAMPS / Block diagram including JOG .....	72
6.2.2	RUN MODE RAMPS / Ramp output monitor PIN 21 .....	73
6.2.3	RUN MODE RAMPS / Forward up time PIN 22 .....	73

6.2.4	RUN MODE RAMPS / Forward down time	PIN 23	73
6.2.5	RUN MODE RAMPS / Reverse up time	PIN 24	73
6.2.6	RUN MODE RAMPS / Reverse down time	PIN 25	73
6.2.7	RUN MODE RAMPS / Ramp input	PIN 26	74
6.2.8	RUN MODE RAMPS / Forward minimum speed	PIN 27	74
6.2.9	RUN MODE RAMPS / Reverse minimum speed	PIN 28	74
6.2.10	RUN MODE RAMPS / Ramp automatic preset	PIN 29	75
6.2.11	RUN MODE RAMPS / Ramp external preset	PIN 30	75
6.2.12	RUN MODE RAMPS / Ramp preset value	PIN 31	75
6.2.13	RUN MODE RAMPS / Ramp S-profile %	PIN 32	75
6.2.14	RUN MODE RAMPS / Ramp hold enable	PIN 33	75
6.2.15	RUN MODE RAMPS / Ramping threshold	PIN 34	76
6.2.16	RUN MODE RAMPS / Ramping flag	PIN 35	76
6.3	CHANGE PARAMETERS / JOG CRAWL SLACK		77
6.3.1	JOG CRAWL SLACK / Block diagram including RUN MODE RAMPS		78
6.3.2	JOG CRAWL SLACK / Jog speed 1 / 2	PINs 37 / 38	79
6.3.3	JOG CRAWL SLACK / Slack speed 1 / 2	PINs 39 / 40	79
6.3.4	JOG CRAWL SLACK / Crawl speed	PIN 41	79
6.3.5	JOG CRAWL SLACK / Jog mode select	PIN 42	80
6.3.6	JOG CRAWL SLACK / Jog/Slack ramp	PIN 43	80
6.4	CHANGE PARAMETERS / MOTORISED POT RAMP		81
6.4.1	MOTORISED POT RAMP / Block diagram		82
6.4.2	MOTORISED POT RAMP / MP output monitor	PIN 45	82
6.4.3	MOTORISED POT RAMP / MP Up / Down time	PINs 46 / 47	82
6.4.4	MOTORISED POT RAMP / MP Up / Down command	PINs 48 / 49	83
6.4.5	MOTORISED POT RAMP / MP Maximum / minimum clamps	PINs 50 / 51	83
6.4.6	MOTORISED POT RAMP / MP preset	PIN 52	83
6.4.7	MOTORISED POT RAMP / MP Preset value	PIN 53	84
6.4.8	MOTORISED POT RAMP / MP memory boot up	PIN 54	84
6.5	CHANGE PARAMETERS / STOP MODE RAMP		85
6.5.1	STOP MODE RAMP / Block diagram		85
6.5.1.1	Block diagram of contactor control		86
6.5.1.2	Speed profile when stopping		87
6.5.1.3	Contactor drop out		87
6.5.1.4	Precise stopping		88
6.5.2	STOP MODE RAMP / Stop ramp time	PIN 56	88
6.5.3	STOP MODE RAMP / Stop time limit	PIN 57	88
6.5.4	STOP MODE RAMP / Live delay mode	PIN 58	89
6.5.5	STOP MODE RAMP / Drop-out speed	PIN 59	89
6.5.6	STOP MODE RAMP / Drop-out delay	PIN 60	89
6.6	CHANGE PARAMETERS / SPEED REF SUMMER		90
6.6.1	SPEED REF SUMMER / Block diagram		90
6.6.2	SPEED REF SUMMER / Internal speed reference 1	PIN 62	91
6.6.3	SPEED REF SUMMER / Auxiliary speed reference 2	PIN 63	91
6.6.4	SPEED REF SUMMER / Speed reference 3 monitor	PIN 64	91
6.6.5	SPEED REF SUMMER / Ramped speed reference 4	PIN 65	91
6.6.6	SPEED REF SUMMER / Speed/Current Reference 3 sign	PIN 66	91
6.6.7	SPEED REF SUMMER / Speed/Current Reference 3 ratio	PIN 67	92
6.7	CHANGE PARAMETERS / SPEED CONTROL		92
6.7.1	SPEED CONTROL / Block diagram		93
6.7.2	SPEED CONTROL / Max positive speed reference	PIN 69	93
6.7.3	SPEED CONTROL / Max negative speed reference	PIN 70	93
6.7.4	SPEED CONTROL / Speed proportional gain	PIN 71	93
6.7.5	SPEED CONTROL / Speed integral time constant	PIN 72	94
6.7.6	SPEED CONTROL / Speed integral reset enable	PIN 73	94
6.7.7	SPEED CONTROL / SPEED PI ADAPTION		94
6.7.7.1	SPEED PI ADAPTION / Low break point	PIN 74	95
6.7.7.2	SPEED PI ADAPTION / High break point	PIN 75	95

6.7.7.3	SPEED PI ADAPTION / Low breakpoint proportional gain	PIN 76	95
6.7.7.4	SPEED PI ADAPTION / Low breakpoint integral time constant	PIN 77	95
6.7.7.5	SPEED PI ADAPTION / Integral % during ramp	PIN 78	95
6.7.7.6	SPEED PI ADAPTION / Speed loop adaption enable	PIN 79	96
6.7.7.7	SPEED PI ADAPTION / Using small speed inputs		96
6.8	CHANGE PARAMETERS / CURRENT CONTROL		97
6.8.1	CURRENT CONTROL / Block diagram		98
6.8.2	CURRENT CONTROL / Current clamp scaler	PIN 81	98
6.8.3	CURRENT CONTROL / CURRENT OVERLOAD		98
6.8.3.1	CURRENT OVERLOAD / Overload % target	PIN 82	99
6.8.3.1.1	Diagram showing O/LOAD % TARGET set to 105%		99
6.8.3.1.2	How to get overloads greater than 150% using 82)O/LOAD % TARGET		100
6.8.3.1.3	Maximum overload table		100
6.8.3.2	CURRENT OVERLOAD / Overload ramp time	PIN 83	100
6.8.4	CURRENT CONTROL / I DYNAMIC PROFILE		101
6.8.4.1	I DYNAMIC PROFILE / Profile enable	PIN 84	101
6.8.4.2	I DYNAMIC PROFILE / Speed break point for high current limit	PIN 85	102
6.8.4.3	I DYNAMIC PROFILE / Speed break point for low current limit	PIN 86	102
6.8.4.4	I DYNAMIC PROFILE / Profile current for low current limit	PIN 87	102
6.8.5	CURRENT CONTROL / Dual current clamps enable	PIN 88	102
6.8.6	CURRENT CONTROL / Upper current clamp	PIN 89	103
6.8.7	CURRENT CONTROL / Lower current clamp	PIN 90	103
6.8.8	CURRENT CONTROL / Extra current reference	PIN 91	103
6.8.9	CURRENT CONTROL / Autotune enable	PIN 92	103
6.8.10	CURRENT CONTROL / Current amp proportional gain	PIN 93	104
6.8.11	CURRENT CONTROL / Current amp integral gain	PIN 94	104
6.8.12	CURRENT CONTROL / Discontinuous current point	PIN 95	105
6.8.12.1	Setting the current loop control terms manually		105
6.8.13	CURRENT CONTROL / 4 quadrant mode enable	PIN 96	105
6.8.14	CURRENT CONTROL / Speed bypass current reference enable	PIN 97	105
6.9	CHANGE PARAMETERS / FIELD CONTROL		106
6.9.1	FIELD CONTROL / Block diagram		107
6.9.2	FIELD CONTROL / Field enable	PIN 99	108
6.9.3	FIELD CONTROL / Voltage output %	PIN 100	108
6.9.4	FIELD CONTROL / Field proportional gain	PIN 101	108
6.9.5	FIELD CONTROL / Field integral gain	PIN 102	108
6.9.6	FIELD CONTROL / FLD WEAKENING MENU		109
6.9.6.1	FLD WEAKENING MENU / Field weakening enable	PIN 103	110
6.9.6.2	FLD WEAKENING MENU / Field weakening proportional gain	PIN 104	110
6.9.6.3	FLD WEAKENING MENU / Field weakening integral time constant	PIN 105	110
6.9.6.4	FLD WEAKENING MENU / Field weakening derivative time constant	PIN 106	110
6.9.6.5	FLD WEAKENING MENU / Field weakening feedback derivative time constant	PIN 107	111
6.9.6.6	FLD WEAKENING MENU / Field weakening feedback integral time constant	PIN 108	111
6.9.6.7	FLD WEAKENING MENU / Spillover armature voltage %	PIN 109	111
6.9.6.8	FLD WEAKENING MENU / Minimum field current %	PIN 110	111
6.9.7	FIELD CONTROL / Standby field enable	PIN 111	112
6.9.8	FIELD CONTROL / Standby field current	PIN 112	112
6.9.9	FIELD CONTROL / Quench delay	PIN 113	112
6.9.10	FIELD CONTROL / Field reference input	PIN 114	112
6.10	CHANGE PARAMETERS / ZERO INTERLOCKS		113
6.10.1	ZERO INTERLOCKS / Block diagram		114
6.10.2	ZERO INTERLOCKS / Standstill enable	PIN 115	114
6.10.3	ZERO INTERLOCKS / Zero reference start enable	PIN 116	114
6.10.4	ZERO INTERLOCKS / Zero interlocks speed level	PIN 117	114
6.10.5	ZERO INTERLOCKS / Zero interlocks current level	PIN 118	115
6.10.6	ZERO INTERLOCKS / At zero reference flag	PIN 119	115
6.10.7	ZERO INTERLOCKS / At zero speed flag	PIN 120	115
6.10.8	ZERO INTERLOCKS / At standstill flag	PIN 121	115

6.10.8.1	Low speed performance .....	115
6.10.9	ZERO INTERLOCKS / SPINDLE ORIENTATE.....	116
6.10.9.1	SPINDLE ORIENTATE / Block diagram.....	117
6.10.9.1.1	Spindle orientate operation .....	117
6.10.9.2	SPINDLE ORIENTATE / Zero speed lock PIN 122.....	118
6.10.9.3	SPINDLE ORIENTATE / Marker enable PIN 240 .....	118
6.10.9.3.1	Marker specification .....	118
6.10.9.4	SPINDLE ORIENTATE / Marker offset PIN 241 .....	119
6.10.9.5	SPINDLE ORIENTATE / Position reference PIN 242.....	120
6.10.9.6	SPINDLE ORIENTATE / Marker frequency monitor PIN 243.....	120
6.10.9.7	SPINDLE ORIENTATE / In position flag PIN 244 .....	120
<b>7</b>	<b>DIAGNOSTICS .....</b>	<b>121</b>
7.1	DIAGNOSTICS / SPEED LOOP MONITOR.....	122
7.1.1	SPEED LOOP MONITOR / Total speed reference monitor PIN 123.....	122
7.1.2	SPEED LOOP MONITOR / Speed demand monitor PIN 124.....	123
7.1.3	SPEED LOOP MONITOR / Speed error monitor PIN 125.....	123
7.1.4	SPEED LOOP MONITOR / Armature volts monitor PIN 126 .....	123
7.1.5	SPEED LOOP MONITOR / Armature volts % monitor PIN 127.....	123
7.1.6	SPEED LOOP MONITOR / Back emf % monitor PIN 128 .....	123
7.1.7	SPEED LOOP MONITOR / Tachogenerator volts monitor PIN 129.....	124
7.1.8	SPEED LOOP MONITOR / Motor RPM monitor PIN 130 .....	124
7.1.9	SPEED LOOP MONITOR / Encoder RPM monitor PIN 132.....	124
7.1.10	SPEED LOOP MONITOR / Speed feedback % monitor PIN 131 .....	124
7.2	DIAGNOSTICS / ARM I LOOP MONITOR.....	125
7.2.1	ARM I LOOP MONITOR / Armature current demand monitor PIN 133 .....	126
7.2.2	ARM I LOOP MONITOR / Armature current % monitor PIN 134.....	126
7.2.3	ARM I LOOP MONITOR / Armature current amps monitor PIN 135.....	126
7.2.4	ARM I LOOP MONITOR / Upper current limit monitor PIN 136 .....	126
7.2.5	ARM I LOOP MONITOR / Lower current limit monitor PIN 137 .....	126
7.2.6	ARM I LOOP MONITOR / Actual prevailing upper/ lower current limits PINs 138 / 139.....	127
7.2.7	ARM I LOOP MONITOR / Overload limit monitor PIN 140.....	127
7.2.8	ARM I LOOP MONITOR / At current limit flag PIN 141 .....	127
7.3	DIAGNOSTICS / FLD I LOOP MONITOR .....	128
7.3.1	FLD I LOOP MONITOR / Field demand monitor PIN 143.....	128
7.3.2	FLD I LOOP MONITOR / Field current % monitor PIN 144.....	128
7.3.3	FLD I LOOP MONITOR / Field current amps monitor PIN 145.....	128
7.3.4	FLD I LOOP MONITOR / Field firing angle of advance monitor PIN 146 .....	129
7.3.5	FLD I LOOP MONITOR / Field active monitor PIN 147 .....	129
7.4	DIAGNOSTICS / ANALOG IO MONITOR .....	130
7.4.1	ANALOG IO MONITOR / UIP2 to 9 analogue input monitor PINs 150 to 157 .....	130
7.4.2	ANALOG IO MONITOR / AOP1/2/3 analogue output monitor PINs 159, 160, 161.....	130
7.5	DIAGNOSTICS / DIGITAL IO MONITOR .....	131
7.5.1	DIGITAL IO MONITOR / UIP2 to 9 digital input monitor PIN 162.....	131
7.5.2	DIGITAL IO MONITOR / DIP1 to 4 and DIO1 to 4 digital input monitor PIN 163 .....	131
7.5.3	DIGITAL IO MONITOR / DOP1 to 3 + Control IPs digital monitor PIN 164 .....	132
7.5.4	DIGITAL IO MONITOR / + Armature bridge flag PIN 165.....	132
7.5.5	DIGITAL IO MONITOR / Drive start flag PIN 166 .....	132
7.5.6	DIGITAL IO MONITOR / Drive run flag PIN 167 .....	132
7.5.7	DIGITAL IO MONITOR / Internal running mode monitor PIN 168 .....	132
7.6	DIAGNOSTICS / BLOCK OP MONITOR .....	133
7.6.1	BLOCK OP MONITOR / General description.....	134
7.7	DIAGNOSTICS / EL1/2/3 RMS MON PIN 169 .....	134
7.8	DIAGNOSTICS / DC KILOWATTS MON PIN 170.....	134
<b>8</b>	<b>MOTOR DRIVE ALARMS .....</b>	<b>135</b>
8.1	MOTOR DRIVE ALARMS menu.....	136
8.1.1	MOTOR DRIVE ALARMS / Speed feedback mismatch trip enable PIN 171 .....	137
8.1.2	MOTOR DRIVE ALARMS / Speed feedback mismatch tolerance PIN 172 .....	139

8.1.3	MOTOR DRIVE ALARMS / Field loss trip enable PIN 173.....	139
8.1.4	MOTOR DRIVE ALARMS / Digital OP short circuit trip enable PIN 174 .....	139
8.1.5	MOTOR DRIVE ALARMS / Missing pulse trip enable PIN 175.....	140
8.1.6	MOTOR DRIVE ALARMS / Reference exchange trip enable PIN 176.....	140
8.1.7	MOTOR DRIVE ALARMS / Overspeed delay time PIN 177 .....	140
8.1.8	MOTOR DRIVE ALARMS / STALL TRIP MENU .....	141
8.1.8.1	STALL TRIP MENU / Stall trip enable PIN 178.....	141
8.1.8.2	STALL TRIP MENU / Stall current level PIN 179 .....	141
8.1.8.3	STALL TRIP MENU / Stall time PIN 180 .....	141
8.1.9	MOTOR DRIVE ALARMS / Active and stored trip monitors PINS 181 / 182 .....	142
8.1.10	MOTOR DRIVE ALARMS / External trip reset enable PIN 183.....	143
8.1.11	MOTOR DRIVE ALARMS / DRIVE TRIP MESSAGE .....	143
8.1.11.1	DRIVE TRIP MESSAGE / Armature overcurrent .....	143
8.1.11.2	DRIVE TRIP MESSAGE / Armature overvolts .....	143
8.1.11.3	DRIVE TRIP MESSAGE / Field overcurrent .....	143
8.1.11.4	DRIVE TRIP MESSAGE / Field loss .....	144
8.1.11.5	DRIVE TRIP MESSAGE / User trip .....	144
8.1.11.6	DRIVE TRIP MESSAGE / Thermistor on T30.....	144
8.1.11.7	DRIVE TRIP MESSAGE / Overspeed .....	144
8.1.11.8	DRIVE TRIP MESSAGE / Speed feedback mismatch .....	145
8.1.11.9	DRIVE TRIP MESSAGE / Stall trip .....	145
8.1.11.10	DRIVE TRIP MESSAGE / Missing pulse .....	145
8.1.11.11	DRIVE TRIP MESSAGE / Supply phase loss .....	145
8.1.11.12	DRIVE TRIP MESSAGE / Synchronization loss.....	146
8.1.11.13	DRIVE TRIP MESSAGE / Heatsink overtemp .....	146
8.1.11.14	DRIVE TRIP MESSAGE / Short circuit digital outputs .....	146
8.1.11.15	DRIVE TRIP MESSAGE / Bad reference exchange .....	146
8.1.11.16	DRIVE TRIP MESSAGE / Cannot autotune .....	147
8.1.11.17	DRIVE TRIP MESSAGE / Autotune quit .....	147
8.1.11.18	DRIVE TRIP MESSAGE / Contactor lock out .....	147
8.1.11.19	DRIVE TRIP MESSAGE / Warning flags .....	147
<b>9</b>	<b>SELF TEST MESSAGE .....</b>	<b>148</b>
9.1.1	SELF TEST MESSAGE / Data corruption.....	148
9.1.2	SELF TEST MESSAGE / Disable GOTO, GETFROM .....	148
9.1.3	SELF TEST MESSAGE / Self cal tolerance .....	148
9.1.4	SELF TEST MESSAGE / Proportional armature current cal fail .....	148
9.1.5	SELF TEST MESSAGE / Integral armature current cal fail.....	148
9.1.6	SELF TEST MESSAGE / Stop drive to adjust parameter .....	149
9.1.7	SELF TEST MESSAGE / Enter password.....	149
9.1.8	SELF TEST MESSAGE / Enable GOTO, GETFROM .....	149
9.1.9	SELF TEST MESSAGE / GOTO CONFLICT .....	149
9.1.10	SELF TEST MESSAGE / Internal error code.....	149
9.1.11	SELF TEST MESSAGE / Authorisation needed.....	149
9.1.12	SELF TEST MESSAGE / Memory write error .....	150
9.1.13	SELF TEST MESSAGE / Memory version error.....	150
9.1.13.1	Transferring files using PL PILOT .....	150
<b>10</b>	<b>SERIAL LINKS, RS232 and FIELDBUS .....</b>	<b>151</b>
10.1	SERIAL LINKS / RS232 PORT1.....	152
10.1.1	RS232 PORT1 / Connection pinouts.....	153
10.1.2	RS232 PORT1 / Port1 Baud rate PIN 187.....	153
10.1.3	RS232 PORT1 / Port1 function PIN 188 .....	153
10.1.4	How to use USB ports.....	153
10.2	RS232 PORT1 / PARAMETER EXCHANGE.....	154
10.2.1	PARAMETER EXCHANGE / Drive transmit.....	154
10.2.1.1	PARAMETER EXCHANGE with a locked recipe page 3. ....	155
10.2.1.2	Transmitting parameter data file to a PC. Windows 95 upwards. ....	155
10.2.2	PARAMETER EXCHANGE / Drive receive .....	156



10.2.2.1	Receiving parameter data file from a PC. Windows 95 upwards.....	156
10.2.3	PARAMETER EXCHANGE / menu list to host .....	157
10.2.3.1	Transmitting a menu list to a PC. Windows 95 upwards.....	157
10.2.3.2	PARAMETER EXCHANGE / Drive to drive.....	158
10.2.3.3	PARAMETER EXCHANGE / Eeprom transfer between units.....	159
10.2.4	Rules of parameter exchange relating to software version.....	159
10.2.5	Parameter exchange using ASCII COMMS .....	160
10.2.5.1	PL PILOT and SCADA (System Control And Data Acquisition) package .....	160
10.3	RS232 PORT1 / PORT1 REF EXCHANGE .....	161
10.3.1	REFERENCE EXCHANGE / Reference exchange slave ratio PIN 189.....	162
10.3.2	REFERENCE EXCHANGE/ Reference exchange slave sign PIN 190 .....	162
10.3.3	REFERENCE EXCHANGE / Reference exchange slave monitor PIN 191 .....	162
10.3.4	REFERENCE EXCHANGE / Reference exchange master monitor PIN 192 .....	162
10.3.5	REFERENCE EXCHANGE / Reference exchange master GET FROM.....	162
<b>11</b>	<b>DISPLAY FUNCTIONS .....</b>	<b>163</b>
11.1	DISPLAY FUNCTIONS / Reduced menu enable.....	163
11.2	DISPLAY FUNCTIONS / PASSWORD CONTROL .....	163
11.2.1	PASSWORD CONTROL / Enter password .....	164
11.2.2	PASSWORD CONTROL / Alter password .....	164
11.3	DISPLAY FUNCTIONS / Language select .....	164
11.4	DISPLAY FUNCTIONS / Software version.....	164
11.5	Remotely mounted display unit.....	164
<b>12</b>	<b>APPLICATION BLOCKS .....</b>	<b>165</b>
12.1	General rules.....	165
12.1.1	Sample times.....	165
12.1.2	Order of processing .....	165
12.1.3	Logic levels .....	166
12.1.4	Activating blocks .....	166
12.1.4.1	Conflicting GOTO connections.....	166
12.1.4.2	Application blocks PIN table.....	166
<b>13</b>	<b>CONFIGURATION .....</b>	<b>167</b>
13.1	CONFIGURATION menu.....	168
13.1.1	PL PILOT configuration tool .....	168
13.2	Configurable connections.....	169
13.2.1	Key features of GOTO window .....	170
13.2.2	Key features of GET FROM window.....	170
13.2.3	Summary of GOTO and GET FROM windows.....	171
13.2.4	JUMPER connections.....	171
13.2.5	Block Disconnect PIN 400 .....	171
13.2.6	Hidden parameters .....	171
13.2.7	CONFIGURATION / ENABLE GOTO, GETFROM .....	172
13.3	CONFIGURATION / UNIVERSAL INPUTS .....	172
13.3.1	UNIVERSAL INPUTS / Block diagram .....	174
13.3.1.1	UIPX SETUP / UIP(2) to (9) Input range PIN 3(2)0 to 3(9)0.....	174
13.3.1.2	UIPX SETUP / UIP(2) to (9) Input offset PIN 3(2)1 to 3(9)1 .....	174
13.3.1.2.1	4-20mA loop input SETUP .....	175
13.3.1.3	UIPX SETUP / UIP(2) to (9) Linear scaling ratio PIN 3(2)2 to 3(9)2 .....	175
13.3.1.4	UIPX SETUP / UIP(2) to (9) Maximum clamp level PIN 3(2)3 to 3(9)3 .....	175
13.3.1.5	UIPX SETUP / UIP(2) to (9) Minimum clamp level PIN 3(2)4 to 3(9)4 .....	175
13.3.1.6	UIPX SETUP / UIP(2) to (9) Make analog GOTO destination connection.....	176
13.3.1.7	UIPX SETUP / UIP(2) to (9) Make digital output 1 GOTO destination connection.....	176
13.3.1.8	UIPX SETUP / UIP(2) to (9) Make digital output 2 GOTO destination connection.....	176
13.3.1.9	UIPX SETUP / UIP(2) to (9) Digital input, high value for output 1 PIN 3(2)5 to 3(9)5 ...	177
13.3.1.10	UIPX SETUP / UIP(2) to (9) Digital input, low value for output 1 PIN 3(2)6 to 3(9)6 ...	177
13.3.1.11	UIPX SETUP / UIP(2) to (9) Digital input, high value for output 2 PIN 3(2)7 to 3(9)7 ..	177
13.3.1.12	UIPX SETUP / UIP(2) to (9) Digital input, low value for output 2 PIN 3(2)8 to 3(9)8 ...	177
13.3.1.13	UIPX SETUP / UIP(2) to (9) Threshold PIN 3(2)9 to 3(9)9 .....	177

13.4	CONFIGURATION / ANALOG OUTPUTS .....	178
13.4.1	ANALOG OUTPUTS / AOP4 Iarm output rectify enable PIN 250 .....	178
13.4.2	ANALOG OUTPUTS / AOP1/2/3/4 SETUP .....	178
13.4.2.1	AOPX SETUP / AOP1/2/3 Dividing factor PINs 251 / 254 / 257 .....	179
13.4.2.2	AOPX SETUP / AOP1/2/3 Offset PINs 252 / 255 / 258 .....	179
13.4.2.3	AOPX SETUP / AOP1/2/3 Rectify mode enable PINs 253 / 256 / 259 .....	179
13.4.2.4	AOPX SETUP / AOP1/2/3 Make output GET FROM source connection .....	179
13.4.2.5	Default connections for AOP1/2/3 .....	179
13.4.3	ANALOG OUTPUTS / Scope output select PIN 260 .....	180
13.5	CONFIGURATION / DIGITAL INPUTS .....	180
13.5.1	Using DIP inputs for encoder signals .....	180
13.5.2	DIGITAL INPUTS / DIPX SETUP .....	181
13.5.2.1	DIPX SETUP / DIP1/2/3/4 Input high value PINs 310 / 312 / 314 / 316 .....	181
13.5.2.2	DIPX SETUP / DIP1/2/3/4 Input low value PINs 311 / 313 / 315 / 317 .....	181
13.5.2.3	DIPX SETUP / DIP1/2/3/4 Make input value GOTO destination connection .....	181
13.5.2.4	Default connections for DIP1/2/3/4 .....	181
13.5.3	DIGITAL INPUTS / RUN INPUT SETUP .....	182
13.5.3.1	RUN INPUT SETUP / RUN input HI value PIN 318 .....	182
13.5.3.2	RUN INPUT SETUP / RUN input LO value PIN 319 .....	182
13.5.3.3	RUN INPUT SETUP / Make input value GOTO destination connection .....	182
13.6	CONFIGURATION / DIGITAL IN/OUTPUTS .....	183
13.6.1	DIGITAL IN/OUTPUTS / DIOX SETUP .....	183
13.6.1.1	DIOX SETUP / DIO1/2/3/4 Output mode enable PINs 271 / 277 / 283 / 289 .....	184
13.6.1.2	DIOX SETUP / DIO1/2/3/4 OP val rectify enable PINs 272 / 278 / 284 / 290 .....	184
13.6.1.3	DIOX SETUP / DIO1/2/3/4 OP comp threshold PINs 273 / 279 / 285 / 290 .....	184
13.6.1.4	DIOX SETUP / DIO1/2/3/4 OP inversion PINs 274 / 280 / 286 / 291 .....	184
13.6.1.5	DIOX SETUP / DIO1/2/3/4 Make output GET FROM source connection .....	185
13.6.1.6	DIOX SETUP / DIO1/2/3/4 Make input GOTO destination connection .....	185
13.6.1.7	DIOX SETUP / DIO1/2/3/4 Input high value PINs 275 / 281 / 287 / 293 .....	185
13.6.1.8	DIOX SETUP / DIO1/2/3/4 Input low value PINs 276 / 282 / 288 / 294 .....	186
13.6.1.9	Default connections for DIO1/2/3/4 .....	186
13.6.1.10	DIO1/2/3/4 Internal output result PINs 685/6/7/8 .....	186
13.7	CONFIGURATION / DIGITAL OUTPUTS .....	186
13.7.1	DIGITAL OUTPUTS / DOPX SETUP .....	186
13.7.1.1	DOPX SETUP / DOP1/2/3 OP val rectify enable PINs 261 / 264 / 267 .....	187
13.7.1.2	DOPX SETUP / DOP1/2/3 OP comparator threshold PINs 262 / 265 / 268 .....	187
13.7.1.3	DOPX SETUP / DOP1/2/3 Output inversion enable PINs 263 / 266 / 269 .....	187
13.7.1.4	DOPX SETUP / DOP1/2/3 Make output GET FROM source connection .....	187
13.7.1.5	Default connections for DOP1/2/3 .....	188
13.7.1.6	DOP1/2/3 Internal output result PINs 682/3/4 .....	188
13.8	CONFIGURATION / STAGING POSTS .....	188
13.8.1	Connecting PINs with different units .....	189
13.8.1.1	Connecting linear values with different units .....	189
13.8.1.2	Connecting logic values with different messages .....	189
13.8.1.3	Connecting to multi-state logic parameters .....	190
13.8.2	STAGING POSTS / Digital / analog 1/2/3/4 PINs 296 to 303 .....	190
13.9	CONFIGURATION / SOFTWARE TERMINALS .....	191
13.9.1	SOFTWARE TERMINALS / Anded run PIN 305 .....	191
13.9.2	SOFTWARE TERMINALS / Anded jog PIN 306 .....	191
13.9.3	SOFTWARE TERMINALS / Anded start PIN 307 .....	192
13.9.4	SOFTWARE TERMINALS / Internal run input PIN 308 .....	192
13.10	CONFIGURATION / JUMPER CONNECTIONS .....	193
13.10.1	JUMPER CONNECTIONS / Make jumper GET FROM source connection .....	193
13.10.2	JUMPER CONNECTIONS / Make jumper GOTO destination connection .....	193
13.11	CONFIGURATION / BLOCK OP CONFIG .....	194
13.11.1	BLOCK OP CONFIG / Block outputs GOTO .....	195
13.11.2	Other GOTO windows .....	195
13.12	CONFIGURATION / FIELDBUS CONFIG .....	195

13.13 CONFIGURATION / DRIVE PERSONALITY .....	196
13.13.1 DRIVE PERSONALITY / PASSIVE MOTOR SET .....	196
13.13.2 DRIVE PERSONALITY / Recipe page PIN 677 .....	197
13.13.2.1 Recipe page block diagram .....	197
13.13.3 DRIVE PERSONALITY / Maximum current response PIN 678 .....	198
13.13.4 DRIVE PERSONALITY / Armature current burden resistance PIN 680.....	198
13.13.4.1 50% / 100% rating select.....	199
13.13.4.2 WARNING about changing BURDEN OHMS .....	200
13.13.4.3 Changing control or power cards.....	200
13.14 CONFLICT HELP MENU .....	201
13.14.1 CONFLICT HELP MENU / Number of conflicts.....	201
13.14.2 CONFLICT HELP MENU / Multiple GOTO conflict PIN identifier .....	201
<b>14 Installation.....</b>	<b>203</b>
14.1 Product rating table.....	204
14.2 Product rating labels .....	204
14.3 Semiconductor fuse ratings.....	204
14.3.1 Proprietary fuses.....	205
14.3.2 European stock fuses.....	205
14.3.3 DC semi-conductor fuses .....	206
14.4 PL/X family cover dimensions.....	207
14.5 Mechanical dimensions PL/X 5 - 50.....	208
14.5.1.1 Mounting PL/X 5 - 50 .....	208
14.6 Mechanical dimensions PL/X 65 - 145 .....	209
14.6.1.1 Mounting PL/X 65 - 145.....	209
14.7 Mechanical dimensions PL/X 185 - 265 .....	210
14.7.1.1 Mounting PL/X 185 - 265.....	210
14.7.1.2 Venting models PL/X 185 - 265 using back panel aperture.....	211
14.7.1.3 Venting models PL/X 185 - 265 using standoff pillars.....	211
14.8 Line reactors .....	212
14.9 Wiring instructions.....	213
14.9.1 Wiring diagram for AC supply to L1/2/3 different to EL1/2/3. (E.g. Low voltage field).....	213
14.10 Terminal tightening torques.....	214
14.11 Installation guide for EMC .....	215
14.11.1 3-phase power supply port .....	215
14.11.2 Earthing and screening guidelines .....	215
14.11.3 Earthing diagram for typical installation .....	216
14.11.4 Guidelines when using filters .....	217
14.12 Approvals UL, cUL, CE .....	217
14.12.1 CE Immunity.....	217
14.12.2 CE Emissions.....	217
14.12.3 UL, cUL .....	217
14.13 What to do in the event of a problem .....	218
14.13.1 A simple clarification of a technical issue.....	218
14.13.2 A complete system failure .....	218
<b>15 PIN number tables .....</b>	<b>219</b>
15.1 Numeric tables .....	219
15.1.1 Change parameters 2 - 121 .....	219
15.1.2 Diagnostics and alarms 123 - 183 .....	221
15.1.3 Serial links 187 - 249 .....	222
15.1.4 Configuration 251 - 400 .....	222
15.1.5 Application blocks 401 - 680.....	224
15.1.6 Hidden pins 680 - 720.....	225
15.2 Menu list .....	226
<b>16 Index .....</b>	<b>229</b>
16.1 Record of modifications .....	233
16.2 Record of bug fixes.....	234
<b>17 Changes to product since manual publication .....</b>	<b>234</b>

There is a system block diagram on 4 A3 sheets at the back of the manual showing the default connections.

## 2 Warnings

### 2.1 General Warnings

#### **READ AND UNDERSTAND THIS MANUAL BEFORE APPLYING POWER TO THE PL/X DRIVE UNIT**

The PL/X motor drive controller is an open chassis component for use in a suitable enclosure

Drives and process control systems are a very important part of creating better quality and value in the goods for our society, but they must be designed, installed and used with great care to ensure everyone's SAFETY. Remember that the equipment you will be using incorporates...

High voltage electrical equipment  
Powerful rotating machinery with large stored energy  
Heavy components

Your process may involve...

Hazardous materials  
Expensive equipment and facilities  
Interactive components

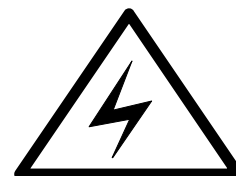

**DANGER**  
**ELECTRIC SHOCK RISK**

Always use qualified personnel to design, construct and operate your systems and keep **SAFETY** as your primary concern.

Thorough personnel training is an important aid to **SAFETY** and productivity.

**SAFETY** awareness not only reduces the risk of accidents and injuries in your plant, but also has a direct impact on improving product quality and costs.

If you have any doubts about the **SAFETY** of your system or process, consult an expert immediately. Do not proceed without doing so.

#### **HEALTH AND SAFETY AT WORK**

Electrical devices can constitute a safety hazard. It is the responsibility of the user to ensure the compliance of the installation with any acts or bylaws in force. Only skilled personnel should install and maintain this equipment after reading and understanding this instruction manual. If in doubt refer to the supplier.

Note. The contents of this manual are believed to be accurate at the time of printing. The manufacturers, however, reserve the right to change the content and product specification without notice. No liability is accepted for omissions or errors. **No liability is accepted for the installation or fitness for purpose or application of the PL/X motor drive unit.**

## 2.2 Warnings and Instructions

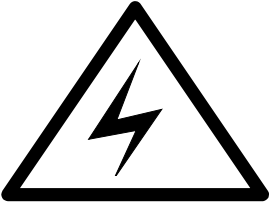

**WARNING**

Only qualified personnel who thoroughly understand the operation of this equipment and any associated machinery should install, start-up or attempt maintenance of this equipment. Non compliance with this warning may result in personal injury and/or equipment damage. Never work on any control equipment without first isolating all power supplies from the equipment. The drive and motor must be connected to an appropriate safety earth. Failure to do so presents an electrical shock hazard.



**CAUTION**

This equipment was tested before it left our factory. However, before installation and start-up, inspect all equipment for transit damage, loose parts, packing materials etc. This product conforms to IPOO protection. Due consideration should be given to environmental conditions of installation for safe and reliable operation. Never perform high voltage resistance checks on the wiring without first disconnecting the product from the circuit being tested.

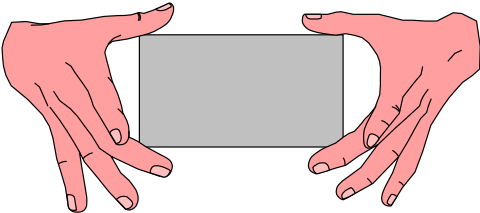

**STATIC SENSITIVE**

This equipment contains electrostatic discharge (ESD) sensitive parts. Observe static control precautions when handling, installing and servicing this product.

**THESE WARNINGS AND INSTRUCTIONS ARE INCLUDED TO ENABLE THE USER TO OBTAIN MAXIMUM EFFECTIVENESS AND TO ALERT THE USER TO SAFETY ISSUES**

**APPLICATION AREA:** Industrial (non-consumer) "Motor speed control utilising DC motors".

**PRODUCT MANUAL:** This manual is intended to provide a description of how the product works. It is not intended to describe the apparatus into which the product is installed.

This manual is to be made available to all persons who are required to design an application, install, service or come into direct contact with the product.

**APPLICATIONS ADVICE:** Applications advice and training is available from Sprint Electric.

## 2.3 General Risks

### INSTALLATION:

#### **THIS PRODUCT IS CLASSIFIED AS A COMPONENT AND MUST BE USED IN A SUITABLE ENCLOSURE**



Ensure that mechanically secure fixings are used as recommended.  
 Ensure that cooling airflow around the product is as recommended.  
 Ensure that cables and wire terminations are as recommended and clamped to required torque.  
 Ensure that a competent person carries out the installation and commissioning of this product.  
 Ensure that the product rating is not exceeded.

### APPLICATION RISK:

#### **ELECTROMECHANICAL SAFETY IS THE RESPONSIBILITY OF THE USER**



The integration of this product into other apparatus or systems is **not** the responsibility of the manufacturer or distributor of the product.

The applicability, effectiveness or safety of operation of this equipment, or that of other apparatus or systems is **not** the responsibility of the manufacturer or distributor of the product.

Where appropriate the user should consider some aspects of the following risk assessment.

**RISK ASSESSMENT:** Under fault conditions or conditions not intended.

- |  |                                      |
|--|--------------------------------------|
| 1. The motor speed may be incorrect.           | 2. The motor speed may be excessive. |
| 3. The direction of rotation may be incorrect. | 4. The motor may be energised.       |

In all situations the user should provide sufficient guarding and/or additional redundant monitoring and safety systems to prevent risk of injury. NOTE: During a power loss event the product will commence a sequenced shut down procedure and the system designer must provide suitable protection for this case.

**MAINTENANCE:** Maintenance and repair should only be performed by competent persons using only the recommended spares (or return to factory for repair). Use of unapproved parts may create a hazard and risk of injury.



**WHEN REPLACING A PRODUCT IT IS ESSENTIAL THAT ALL USER DEFINED PARAMETERS THAT DEFINE THE PRODUCT'S OPERATION ARE CORRECTLY INSTALLED BEFORE RETURNING TO USE. FAILURE TO DO SO MAY CREATE A HAZARD AND RISK OF INJURY.**

**PACKAGING:** The packaging is combustible and if disposed of incorrectly may lead to the generation of toxic fumes, which are lethal.

**WEIGHT:** Consideration should be given to the weight of the product when handling.

**REPAIRS:** Repair reports can only be given if the user makes sufficient and accurate defect reporting.

Remember that the product without the required precautions can represent an electrical hazard and risk of injury, and that rotating machinery is a mechanical hazard.

### PROTECTIVE INSULATION:

1. All exposed metal insulation is protected by basic insulation and **user** bonding to earth i.e. Class 1.
2. Earth bonding is the responsibility of the installer.
3. All signal terminals are protected by basic insulation, and the **user** earth bonding. (Class 1). The purpose of this protection is to allow safe connection to other low voltage equipment and is not designed to allow these terminals to be connected to any un-isolated potential.

It is essential that all the following warnings are read and understood.

## 2.4 Summary of further WARNINGS

This summary is provided for convenience only. Please read the entire manual prior to first time product use.

**0V on T13 must be used for protective clean earth connection.**

**Terminals T30 and T36 must be linked if external over-temperature sensors are not used.**

See 3.5 Control terminal default functions.

**WARNING.** Do not rely on any drive function to prevent the motor from operating when personnel are undertaking maintenance, or when machine guards are open. Electronic control is not accepted by safety codes to be the sole means of inhibition of the controller. Always isolate the power source before working on the drive or the motor or load. See 3.5 Control terminal default functions.

**The CSTOP must be high for at least 50mS prior to START going high.**

See 3.5 Control terminal default functions.

**Contactor coils usually have a high inductance. When the contactor is de-energised it can produce high energy arcing on the internal PL/X control relay. This may degrade the life of the relay and/or produce excessive EMC emissions. Ensure that the contactor coil is snubbed. Refer to contactor supplier for details.**  
See 4.2 Main Contactor operation.

The essential elements of controlling the contactor are as follows.

- 1) It must be possible to release the contactor without relying on electronics.
- 2) The contactor must not break current. To obey this rule the following applies:-
  - a) The PL/X must not attempt to deliver armature current until after the contactor has closed.
  - b) The armature current must be brought to zero before the contactor has opened.
- 3) The contactor control circuit must be compatible with all likely application requirements.

Follow the instructions and all the above requirements are under the control of the PL/X automatically.

See 4.2 Main Contactor operation.

It may be necessary for installations to have over-riding external independent systems for de-energising the main contactor. In this case it is recommended that the CSTOP terminal be opened 100mS in advance of the main contacts opening. Failure to achieve this may result in damage to the unit.

**Note.** If the users main contactor has a closing time delay of greater than 75mS, then it is essential that steps are taken to delay the release of armature current until the main contact has closed.

- 1) Insert an auxiliary normally open contact on the main contactor in series with the RUN input on T31.
- 2) Alternatively use contactor wiring method shown in 4.3.2. See 4.2 Main Contactor operation.

It is dangerous to utilise a DC contactor when field weakening is employed without also connecting T41 and T43 to the motor armature. This ensures that the PL/X can measure the armature voltage even when the contactor is open. See 4.3.3 Main contactor isolating DC armature.

This is a summary of the essential parameters that should be checked prior to allowing power to the motor. You must be able to put a tick against every section. Failure to comply with these requirements may cause incorrect functioning or damage to the drive and/or installation and will invalidate any warranty.

See 4.4 ESSENTIAL pre-start checks.

**All external fuses must be of the correct rating and type. The I<sup>2</sup>t rating must be less than the rating specified in the rating tables. This includes main and auxiliary fuses.**

See 4.4 ESSENTIAL pre-start checks.

**Check the 3 phase auxiliary supply phasing on ELI /2/3 equates to the phasing of the main stack supply on LI/2/3, and the 1 ph control supply on T52/53 is correct.** See 4.4 ESSENTIAL pre-start checks.

**Disconnect the drive for wiring tests using a megger.**

See 4.4 ESSENTIAL pre-start checks.



If the load regenerates or regenerative braking is employed, then a DC rated armature fuse with the correct I<sup>2</sup>t rating in series with the motor armature is highly recommended.

See 4.4 ESSENTIAL pre-start checks.

A protective clean earth connection must be made to the control 0V on T13 to ensure that the installation complies with protective class1 requirements. See 4.4 ESSENTIAL pre-start checks.

The emergency stopping and safety procedure, including local and remote actuators must be checked prior to applying power to the motor. See 4.4 ESSENTIAL pre-start checks.

If you wish to abandon changes made since the last save, simply remove the control supply WITHOUT having performed parameter save. See 5.1.2 PARAMETER SAVE.

Sometimes it is useful to return a unit to its default setup condition. E.g. a trial configuration may prove to be unworkable and it is easier to start again. If all 4 keys are held down during the application of the control supply, then the drive will automatically display the default parameters and connections. **(EXCEPT those in the CALIBRATION menu, and 100)FIELD VOLTS OP % for MOTOR 1 and MOTOR 2, and 680)Iarm BURDEN OHMS**). The defaults will only be permanently retained however if they are then saved using the PARAMETER SAVE menu. To revert to the last saved set, simply turn the control supply off, without doing a PARAMETER SAVE and on again.

**Also the PASSWORD is reset to 0000.** See 11.2 DISPLAY FUNCTIONS / PASSWORD CONTROL.

See also 13.13.2 DRIVE PERSONALITY / Recipe page PIN 677, for details of 2 and 3 key reset operation and power up messages. See 5.1.3 Restoring the drive parameters to the default condition.

If your DESIRED MAXIMUM RPM is higher than the BASE RATED RPM then you will need to implement field weakening in the CHANGE PARAMETERS / FIELD CONTROL menu. **You must however verify that your motor and load are rated for rotation above base speed. Failure to do so may result in mechanical failure with disastrous consequences.** If however your desired maximum rpm is low compared to the base rpm then you need to be aware of the heat dissipation in the motor at full torque. Use motor force venting if necessary. See 6.1.6 CALIBRATION / Desired max rpm PIN 6 QUICK START.

**WARNING. Do not use AVF feedback mode with field weakening systems.** See 6.9.6 FIELD CONTROL / FLD WEAKENING MENU for a note about AVF / field weakening trip.

AVF feedback contains more ripple than tacho feedback. It may be necessary for smooth operation to reduce the SPEED CONTROL loop gain with AVF. See 6.7.4 SPEED CONTROL / Speed proportional gain PIN 71.

See 6.1.9 CALIBRATION / Speed feedback type PIN 9 QUICK START.

When the drive is first being commissioned it is recommended that the AVF mode be used initially. This allows any other speed feedback transducers to be examined for correct outputs prior to relying on them for control safety. **For systems employing a DC contactor you must use T41 and T43 for remote AVF.**

See 6.1.9 CALIBRATION / Speed feedback type PIN 9 QUICK START.

**Current loop control terms. If you change your supply voltage, current calibration or motor type, the 3 values for PINs 93/94/95 must be adjusted accordingly. (Either by using the AUTOTUNE function or manually).**

See 6.8.9 CURRENT CONTROL / Autotune enable PIN 92

See 6.8.12.1 Setting the current loop control terms manually.

**Warning. Field reversal or disconnection.**

Due to the high inductance of motor fields it may take several seconds for the field current to decay to zero after the field output has been inhibited by the PL/X. **Do not open circuit the field unless the field current has reached zero.** See 6.9 CHANGE PARAMETERS / FIELD CONTROL.

**WARNING. When using field weakening and a DC side power contactor, the motor armature must be connected to the REMOTE AV sensing terminals T41 and T43. Failure to do this will cause flashover of the commutator because the AVF feedback is lost when the contactor opens.**

See 6.9.6 FIELD CONTROL / FLD WEAKENING MENU.

**WARNING.** All these alarms are generated by semiconductor electronics. Local safety codes may mandate electro-mechanical alarm systems. All alarms must be tested in the final application prior to use. The suppliers and manufacturers of the PL/X are not responsible for system safety.  
See 8.1 MOTOR DRIVE ALARMS menu.

**WARNING.** The feedback loss protection afforded in field weakening mode is limited to total feedback loss only. This is because the speed / AVF relationship is not maintained in field weakening mode. If a partial loss of feedback occurs the motor may run to excessive speed. When the field has been completely weakened and is at its minimum level, the armature overvoltage trip will come into operation. This may only occur at a dangerous speed. It is therefore recommended that a mechanical device and or back up system be utilised to protect against this possibility. See 6.9.6.8 FLD WEAKENING MENU / Minimum field current % PIN 110.  
And 8.1.1 MOTOR DRIVE ALARMS / Speed feedback mismatch trip enable PIN 171.

**WARNING.** For rated field currents that are less than 25% of model rating the alarm threshold may be too low to trigger. The alarm must be tested. To overcome this problem, 4)RATED FIELD AMPS may be set to a higher level and 114)FIELD REFERENCE set lower. This has the effect of raising the threshold.  
E.g. Set 4)RATED FIELD AMPS to twice motor rating and 114)FIELD REFERENCE to 50.00%.  
See 8.1.3 MOTOR DRIVE ALARMS / Field loss trip enable PIN 173

**WARNING.** When using armature voltage feedback the IR drop may be sufficient to provide a signal in excess of 117)ZERO INTLK SPD % and hence the stall alarm will not operate. Set 14)IR COMPENSATION as accurately as possible, and then test the alarm with a stalled motor. (Disable the field) Progressively increase current limit to above the 179)STALL CUR LEVEL, to check that the AV speed feedback remains below 117)ZERO INTLK SPD %. It may be necessary to increase 117)ZERO INTLK SPD % to ensure tripping.  
See 8.1.8.1 STALL TRIP MENU / Stall trip enable PIN 178.

After a DATA CORRUPTION message. Check that the calibration parameters and drive personality alarm burden value are correct. See 9.1.1 SELF TEST MESSAGE / Data corruption.

Warning the 24V supply on pin 2 may damage your PC or other instrument. If in doubt do not connect it. The transmit must be connected to the receive on each port. See 10.1.1 RS232 PORT1 / Connection pinouts.

Parameter exchange general **WARNING.** Check the CALIBRATION parameters are correct after any process of PARAMETER EXCHANGE. See 10.2 RS232 PORT1 / PARAMETER EXCHANGE.  
And 10.2.3.3. PARAMETER EXCHANGE / Eeprom transfer between units.

**WARNING** about changing BURDEN OHMS. It is important that 680)Iarm BURDEN OHMS, is set as closely as possible to the actual resistance used on the power board. DO NOT ALLOW THE MODEL RATING TO EXCEED THE VALUES IN THE RATING TABLE AND ON THE RATING LABEL FOUND UNDER THE UPPER END CAP. FAILURE TO HEED THIS WARNING WILL INVALIDATE ANY WARRANTY, AND VIOLATE APPROVAL STANDARDS. NO LIABILITY IS ACCEPTED BY THE MANUFACTURER AND/OR DISTRIBUTOR FOR FAULTS CAUSED BY RE-RATING OF THE PRODUCT. See 13.13.4.2 WARNING about changing BURDEN OHMS.

**WARNING.** All units must be protected by correctly rated semi-conductor fuses. Failure to do so will invalidate warranty. See 14.3 Semiconductor fuse ratings.

**WIRING INSTRUCTIONS. VERY IMPORTANT.** Read all warnings in section 14.9

**WARNING** Safety earthing always takes precedence over EMC earthing.  
See 14.11.2 Earthing and screening guidelines.

	<b>IMPORTANT SAFETY WARNINGS</b>		
	The AC supply filters must not be used on supplies that are un-balanced or float with respect to earth	The drive and AC filter must only be used with a permanent earth connection. No plugs/sockets are allowed in the AC supply	The AC supply filter contains high voltage capacitors and should not be touched for a period of 20 seconds after the removal of the AC supply

See 14.11.4 Guidelines when using filters.

### 3 Introduction and Technical Data

<b>3</b>	<b>Introduction and Technical Data .....</b>	<b>19</b>
3.1	Introduction .....	20
3.2	How do they work? .....	20
3.2.1	Useful things to know about the PL/X.....	21
3.2.2	Tips for using the manual .....	21
3.3	General Technical Data.....	22
3.3.1	Regenerative stopping with PL models .....	22
3.3.2	Supply voltages required for all models .....	22
3.3.3	Control terminals electrical specification.....	24
3.4	Control terminals overview. ....	25
3.4.1	General requirements.....	25
3.4.2	Digital inputs and outputs .....	25
3.4.3	Analogue inputs.....	26
3.4.4	Analogue tachogenerator input .....	27
3.4.5	Signal test pins .....	27
3.5	Control terminal default functions .....	27
3.5.1	Run, Jog, Start, Cstop.....	29
3.5.2	Summary of default terminal functions.....	31
3.6	Supply loss shutdown .....	32

### 3.1 Introduction

The PL/X DC motor controller uses closed loop control of armature current and feedback voltage to give precise control of motor torque and speed. The unit also controls the motor excitation field. The closed loop parameters are programmable by the user and a wealth of inputs and outputs are provided to allow very complex motion control processes to be achieved. The series is comprised of 3 chassis variants each with 2 and 4 quadrant models. **Selected 2 quadrant models also offer a unique regenerative stopping facility.**

These units are very compact. The savings made possible in panel space and enclosure costs may be significant.

Programming the unit is designed to be simple. A large backlit alphanumeric display guides the user through a friendly menu structure to select options and parameter changes. Built in application software blocks are provided to be connected up as desired. Comprehensive fault monitoring and serial communications allow off site programming and remote diagnostics. All models, plus fuses, filters and line reactors are stock items.

### 3.2 How do they work?

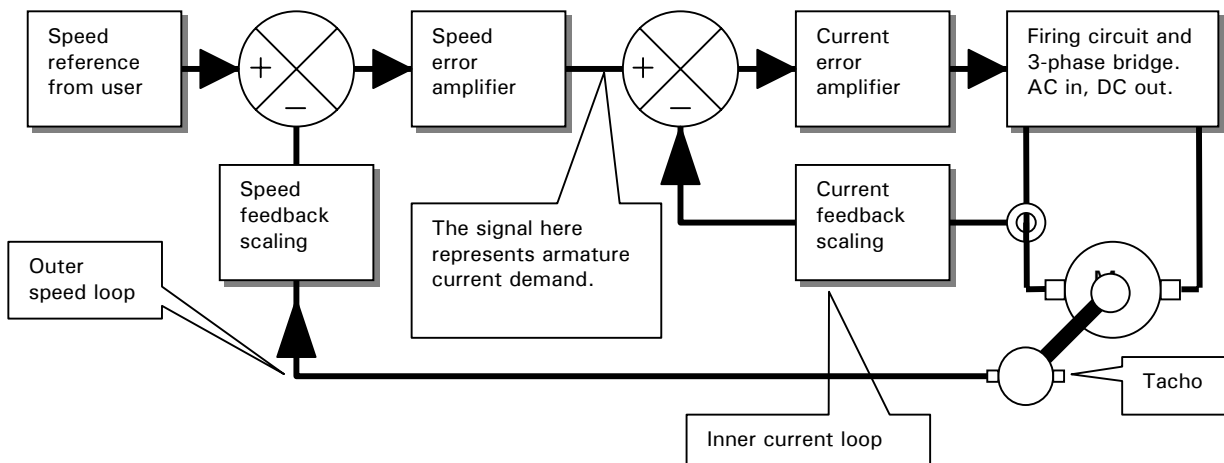

This shows the basic arrangement of the drive control loops. The 3-phase thyristor bridge is a phase-controlled rectifier, which delivers power to the motor armature. The armature current (and hence the motor torque) is sensed to provide feedback to the inner current loop. After being scaled this is compared to the current demand. The current error amplifier is able to detect any difference, and then act in such a way that the current feedback remains identical to the current demand during normal operation. This inner loop monitors the armature current and delivers more current or less current as required.

The outer speed loop works in the same way as the inner current loop but uses different parameters. In the above example, the demand is provided by the user in the form of a speed reference, and the speed feedback is derived from a shaft-mounted tachometer. Any difference is detected and translated into a new current demand level. This level provides the right amount of current (and hence torque) to reduce the speed error to zero. This new demand level is presented to the inner current loop, which obeys as rapidly as possible.

The whole process is performed on a continuous basis giving superb speed accuracy and dynamic performance. In typical systems, there are numerous house keeping tasks and interface requirements. For these, the PL/X series has a wealth of standard features to benefit the user.

A range of standard application blocks is included, with a user-friendly configuration facility that displays a description of the selected connection points. The programming menu is designed for rapid travel to the desired parameter using 4 keys and a large backlit alphanumeric display. A large number of monitoring facilities is available to enable display of all points in the block diagram.

The unit is supplied with **PL PILOT**, a superb PC windows based configuration and monitoring tool. (Note. Also available is the PLA, with applications blocks, I/O modules and comms facilities only)

### 3.2.1 Useful things to know about the PL/X

- 1) The unit comes from the factory with a built in default personality which will be suitable for most applications, but may be re-programmed by the user. Up to 3 total instrument recipes can be stored.
- 2) The default personality can be restored by holding down all 4 keys and applying the control supply, but the calibration values relevant to the motor are unaffected by this procedure. See 5.1.3 and 13.13.2
- 3) There are over 700 programmable parameters available, but only a handful of these will need to be adjusted by most users.
- 4) Internal connections between blocks and parameters are easily altered to suit special applications.
- 5) All parameters have a unique identification number called a PIN (Parameter Identification Number)
- 6) When parameters are altered by the user they become effective immediately. However the alterations will be lost if the control supply is removed prior to performing a parameter save.
- 7) Most parameters may be adjusted while the drive is running to assist commissioning. If this is not advisable the unit requests a stop condition.
- 8) There is a built in 'meter' which allows monitoring of all relevant inputs and outputs including power connections, in engineering units and percentages. There are also default % diagnostic summary windows.
- 9) There is a large selection of robust inputs and outputs to interface with typical systems.
- 10) The drive personality is stored in one memory device which is designed to be transportable to another unit in the event of a breakdown. See 10.2.3.3 PARAMETER EXCHANGE / Eeprom transfer between units.
- 11) All the drive parameter values may be listed out on a printer. Parameters that have been altered from the default are identified in the listing. They may also be sent to, or received from, another unit or computer.
- 12) The unit contains standard special applications blocks that are normally switched off unless activated by the user. These include signal processors, PIDs etc. They do not take part in the prime control of the motor, but may be used to construct more complex systems at no extra cost.
- 13) There is a facility to provide a super fast current response for high performance applications. See 13.13.3 DRIVE PERSONALITY / Maximum current response PIN 678.

### 3.2.2 Tips for using the manual

**This is a version 5.14 manual. Version 5.14 and above software has all the functions described.**  
See 5.1.7 Finding the software version number of the unit. 11.5 Remotely mounted display unit

- 1) Do not be intimidated by the size of the manual. Important facts are frequently mentioned more than once to avoid excessive cross referencing.
- 2) The manual looks large because it contains many graphics. For instance every parameter is described showing a picture of the actual display as the user will see it.
- 3) The sequence of the chapters flows in a similar sequence to the drive block diagram.
- 4) Every parameter has its own paragraph number which makes it easy to find.
- 5) There is a set of PIN number tables at the back, which cross reference to the paragraph number for every parameter.
- 6) There is a complete contents listing at the front of the manual giving paragraph and page numbers. Each chapter also has its own contents listing. There is also an index in section 16 at the back of the manual.
- 7) There will always be typing and technical errors in a complex document. Please inform your supplier of any errors you find. The authors are grateful for any information that will allow improvements to be made.

### 3.3 General Technical Data

Rating table

Maximum continuous shaft ratings

Model		kW at 460V	HP at 460V	HP at 500V	100% Armature Current DC Amps	100% Field Amps	Dimensions mm  (force vented = fv)  W x H x D
PL 2 quadrant PLX 4 quadrant							
* PL and PLX	5	5	6.6	7.5	12	8	216 x 289 x 174
* PL and PLX	10	10	13.3	15	24	8	216 x 289 x 174
* PL and PLX	15	15	20	20	36	8	216 x 289 x 174
* PL and PLX	20	20	26.6	30	51	8	216 x 289 x 174
* PL and PLX	30	30	40	40	72	8	216 x 289 x 174 fv
* PL and PLX	40	40	53.3	60	99	8	216 x 289 x 174 fv
* PL and PLX	50	50	66.6	75	123	8	216 x 289 x 174 fv
PL and PLX	65	65	90	100	155	16	216 x 378 x 218 fv
PL and PLX	85	85	115	125	205	16	216 x 378 x 218 fv
PL and PLX	115	115	155	160	270	16	216 x 378 x 218 fv
* PL and PLX	145	145	190	200	330	16	216 x 378 x 218 fv
PL and PLX	185	185	250	270	430	32 or 50	216 x 378 x 294 fv
* PL and PLX	225	225	300	330	530	32 or 50	216 x 378 x 294 fv
PL only	265	265	350	400	630	32 or 50	216 x 378 x 294 fv

#### 3.3.1 Regenerative stopping with PL models

\* Starred models: (\*PL) 2 Quadrant models have electronic regenerative stopping.  
See 6.5.2 STOP MODE RAMP / Stop ramp time PIN 56.

#### 3.3.2 Supply voltages required for all models

The supplies provided must be suitable for the motor employed

##### Main 3 phase 50 - 60Hz

Any supply from 12 to 480V AC +/- 10% for armature power.

##### Auxiliary 3 phase 50 - 60Hz

Any supply from 100 to 480V AC +/- 10% for field power.

##### Control 1 phase 50 - 60Hz

Any supply from 110 to 240V AC +/- 10% 50VA. This is required to power the PL/X electronic circuits.

PL/X 185/225/265 models also need a 50VA 110V 50/60Hz ac fan supply

#### OUTPUT VOLTAGE RANGE

Armature PL 0 to +1.2 times AC supply. PLX 0 to +/- 1.2 times AC supply.  
Note. 1.1 times AC supply is recommended if supply variations exceed -6%.  
Field 0 to 0.9 times AC supply on auxiliary terminals. (EL1, EL2, EL3)

#### OUTPUT CURRENT RANGE

Armature 0 to 100% continuous. 150% for 25 seconds +/- for PLX  
Field programmable minimum to 100% continuous with fail alarm.  
Note. There is a factory option to allow high inductance loads to be driven by the armature output.

Note. The 3 phase Field and Armature supplies are input through separate terminals and may be at different levels if desired. See 14.9.1 Wiring diagram for AC supply to L1/2/3 different to EL1/2/3. (E.g. Low voltage field)  
**They must however, be in phase**

Control Circuits:	Fully isolated from power circuit.		
Control Action:	Fully digital. Advanced PI with fully adaptive current loops for optimum dynamic performance. Self-Tuning Current Loop utilising "Autotune" algorithm. Adjustable speed PI with integral defeat.		
Speed Control:	By Armature Voltage feedback with IR compensation. By encoder feedback or analogue tachogenerator. By a combination of encoder feedback and analogue tachogenerator or AVF. Speed range 100 to 1 typical with tachogenerator feedback.		
Steady State Accuracy:	0.1 % Analogue Tachogenerator Feedback. (subject to tachogenerator) 2 % Armature Voltage Feedback 0.01% Encoder only, Encoder + tacho, encoder + AVF – (With digital reference) Maximum encoder frequency 100KHz		
Protection:	Interline device networks. Overcurrent (instantaneous). Field failure. Motor over-temperature. Thyristor "Trigger" failure. Standstill logic.	High energy MOV'S. Overcurrent 150% for 25s. Tacho failure. (With auto AVF back-up option). Thyristor Stack over-temperature. Zero-speed detection. Stall protection.	
Diagnostics:	With first fault latch, automatic display and power off memory. Diagnostic monitoring of all parameters in engineering and/or % units. Full diagnostic information available on RS232 using PL PILOT graphical tool. Digital I/O logic status plus automatic default % diagnostic summary windows		
Temperature:	0-50C ambient enclosure internal operating temperature -25C - +55C storage Protect from direct sunlight. Ensure dry, corrosive free environment.		
Humidity:	85% Relative humidity maximum. Note: - Relative humidity is temperature dependent, do not allow condensation.		
Atmosphere:	Non-flammable, non-condensing. Pollution Degree: 2, Installation cat: 3		
Short circuit-rating:	Suitable for use on a circuit capable of delivering not more than 5000A PL/X5-30, 10,000A PL/X40-145, 18000A PL/X185-265 RMS symmetrical amperes, 480 Volts AC maximum, when protected by Ar class fuses. (See fuse table)		
Field output modes:	Constant current, Constant voltage, Automatic weakening Delayed quenching after stop command to allow dynamic braking Economy mode to leave field excited at low level to prevent motor cooling Field supply inputs independent from armature supply inputs		
Special features:	Field weakening Dual motor swap PC configuration and monitoring tool	Motorised pot simulator Spindle orientation	Connection Conflict Checker 3 Total Instrument Recipe pages Family of remote interface units.
Application blocks:	Centre winding, 2 Summers, Batch counter, Latch, 8 Multi-function, Preset Speed, 2 PIDs, Parameter profiler, 4 Comparators, 4 Changeover switches, Delay timer, Filters.		
Serial comms	RS232 port, ANSI-X3.28-2.5-B I multi-drop. Fieldbus options. Profibus, Devicenet.		

## 3.3.3 Control terminals electrical specification

This describes the electrical spec. of the control terminals. The function that each terminal has may depend on the programmed choice of the user. The units are shipped with a set of default terminal functions, which are described later. Although the function of the terminal may change its electrical specification does not.

<u>UNIVERSAL INPUTS</u>	8 analogue inputs with up to 5mV + sign resolution (+/- 0.4%)	0V	1	
	4 input voltage ranges +/-5/10/20/30V on each input	UIP2	2	
<u>UIP2 – UIP9</u>	8 digital inputs with settable thresholds. <b>Good noise immunity.</b>	UIP3	3	
	Overvoltage protected to +/-50V	UIP4	4	
	Input impedance 100K for input scaling at 5 and 10V range	UIP5	5	
	<u>Input impedance 50K for input scaling above 10V range</u>	UIP6	6	
		UIP7	7	
<u>ANALOGUE OUTPUTS</u>	4 analogue outputs (+/- 0.4%)	UIP8	8	
	3 programmable, 1 committed to output armature current signal	UIP9	9	
<u>AOP1 AOP2 AOP3</u>	2.5mV plus sign resolution	AOP1	10	
and <u>IARM</u> on T29	Short circuit protection to 0V. Output current +/-5mA maximum	AOP2	11	
	<u>Output range 0 to +/-11V.</u>	AOP3	12	
<u>DIGITAL INPUTS</u>	4 digital inputs	0V	13	
	<b>Logic low below 2V, Logic high above 4V. Low noise immunity.</b>	DIP1	14	
<u>DIP1 - DIP4</u>	Overvoltage protection to +50V. Input impedance 10K Ohms	DIP2	15	
	<b>DIP3 and DIP4 may also be used for encoder quadrature signals</b>	DIP3	16	
	<u>Encoder input freq. up to 100Khz on DIP3 and DIP4</u>	DIP4	17	
<u>DIGITAL IN/OUTPUTS</u>	4 digital inputs. Also programmable as outputs (see digital outputs)	DIO1	18	
	<b>Logic low below 6V. Logic high above 16V.</b>	DIO2	19	
<u>DIO1 – DIO4</u>	Overvoltage protection to +50V. Input impedance 10K Ohms	DIO3	20	
	<u>When used as digital outputs the spec. is the same as DOP1-3</u>	DIO4	21	
<u>DIGITAL OUTPUTS</u>	3 outputs (for 4 more outputs with this spec. use DIO1/2/3/4)	DOP1	22	
	Short circuit protected. (Range 22 to 32 Volts for OP high)	DOP2	23	
<u>DOP1 – DOP3</u>	Over-temperature and over-voltage protected to +50V	DOP3	24	
	Each output can deliver up to 350mA. Total for all outputs of 350mA,			
	<u>This spec. also applies to DIO1/2/3/4 when they are programmed as outputs</u>			

This connector is devoted to essentially fixed function controls

<u>TACH INPUT</u>	+/- 200V range	0V	25	
	Input impedance 150K Ohms	TACH	26	
		+10	27	
<u>REFERENCE OUTPUTS</u>	+/-10.00V, 0.5%, 10mA max. Short circuit protection to 0V.	-10	28	
		IARM	29	
<u>ARMATURE CURRENT</u>	+/-5V linear output for +/-100% <b>model</b> rating current.	THM	30	
	Output current capability 10mA max. Short circuit protection to 0V.	RUN	31	
<u>IARM</u>	Programmable Uni-polar or Bi-polar output mode (tolerance +/-5%).	JOG	32	
		START	33	
<u>THERMISTOR INPUT</u>	Motor temperature thermistor. If unused then connect to 0V.	CSTOP	34	
<u>THM</u>	OK < 200 Ohms, Overtemp > 2K Ohms. Connect from THM to 0V	+24V	35	
		0V	36	
<u>CONTACTOR control</u>	24V Logic inputs. <b>Logic low below 6V, logic high above 16V</b>			
	Input impedance. 10K Ohms. Overvoltage protection to +50V			
<u>RUN</u>	Drive enable. Electronic enable for current loop and contactor drop out delays			
<u>JOG</u>	Jog input with programmable contactor drop out delay			
<u>START</u>	Start/stop. Drops contactor out at zero speed.			

The drive will not start unless all alarms are clear. The drive will not restart after alarm induced contactor drop out, unless START is removed for at least 50mS and re-applied.

CSTOP Coast stop. Drops contactor out immediately (100ms). Input impedance 10K Ohms.  
+24V +24V output for external logic (**Range 22 to 32 Volts**). Short circuit protected.  
 Overvoltage protection to +50V. Shares total current capability of 'Digital Outputs' (350mA), plus extra 50mA of its own. Total maximum available 400mA.



<b>Control terminals on lower power board numbers 41 to 53 (NC signifies no connection)</b>		RA +	41	
		NC	42	
<b>REMOTE AVF</b>	<b>RA + RA-</b> used for remote sensing of armature volts (Note, when using remote AVF, the Armature volts signal is read 3.3% high)	RA-	43	
		NC	44	
<b>CON1 and CON2</b>	Volt free contact for main contactor coil up to 240V 500VA. Operated by START/JOG function, when CSTOP is high	CON1	45	
		CON2	46	
<b>LATCH1 and LATCH2</b>	Volt free contact operates at same time as CON1/2 240V 500VA.	LAT1	47	
		LAT2	48	

<b>EARTH</b> on 51 is used for dirty earth connection of control supply	EARTH	51	
	N	52	
<b>L and N</b> are for control power 100-240V, 50 - 60Hz +/-10%, 50VA	L	53	

**Note.** The control supply is required to power the PL/X electronics and must be applied before running.

### 3.4 Control terminals overview.

#### 3.4.1 General requirements

The general requirements of industrial process equipment are that apart from performing their intrinsic function, they must interface with external systems. The most common requirements are for 4 types of interface.

Analogue inputs, able to accept linear bi-polar reference or feedback signals.

Analogue outputs able, to provide linear bi-polar signals.

Digital inputs able, to recognise logic levels using 24V logic.

Digital inputs for encoders signals of various amplitudes and type.

Digital outputs able, to drive 24V relays, lamps, sensors etc.

System requirements are variable. Some require a lot of one type of interface, others a selection of all types. The designers of the PL/X series of drives have attempted to provide sufficient of all types to meet all conceivable requirements. This has been achieved by making many of the terminals dual function. The possible boundaries are as follows.

Up to 17 digital inputs, 8 analogue inputs 7 digital outputs 4 analogue outputs

This is achieved by allowing the 8 analogue inputs to also be used as digital inputs, and 4 digital outputs that can be independently programmed as inputs.

The analogue outputs do not usually need to be so numerous, as software connections can be made by the user. Even so 4 analogue outputs are available of which 3 are programmable. The analogue outputs are individually short circuit protected to 0V. However they are not protected for simultaneous shorts.

#### 3.4.2 Digital inputs and outputs

An important consideration is the ability of the equipment to survive a harsh environment. The most frequent types of problem are short circuits and excessive voltages being applied to the digital inputs and outputs. All the digital inputs and outputs can withstand up to +50V applied continuously. All digital outputs, including the 24V customer supply have been designed to withstand a direct short circuit to 0V. If a short circuit or overload occurs on one or more of the digital outputs, then all digital outputs are disabled and the short circuit condition is flagged. It is possible to enable or disable a drive trip in this event. Providing the fault has not caused external user relay logic to interrupt normal running, then the drive will continue to run if the trip is disabled. The short circuit condition may be signalled on one of the outputs by a low state if desired. If the short circuit is removed the digital outputs will recover to their original state. See 8.1.4 MOTOR DRIVE ALARMS / Digital OP short circuit trip enable PIN 174 and 8.1.11.14 DRIVE TRIP MESSAGE / Short circuit digital outputs and 7.5 DIAGNOSTICS / DIGITAL IO MONITOR.

**Note.** The DIP digital inputs on T14-17 are also characterised for use as encoder inputs (**hence low noise immunity**). The DIO digital input/outputs on T18-21 are characterised for 24V logic (**standard noise immunity**). The UIP analogue inputs on T2-9 can also be used as digital inputs. (**optimum noise immunity**).

### 3.4.2.1 Encoder inputs

Note. DIP3 (T16, B train or sign) and DIP4 (T17, A train) are designed to accept bi-directional encoder pulse trains. DIP2 (T15) is designed to accept a MARKER for spindle orientation. The encoder outputs must be able to provide a logic low below 2V, a logic high above 4V, may range up to 50V max and up to 100KHz. These 2 inputs are single ended and non-isolated. For other types of encoder output, the user must provide some external conditioning circuitry. The output format may be pulse only for single direction, pulse with sign, or phase quadrature. See 6.1.10 CALIBRATION / ENCODER SCALING.

**Note. The UIPs offer much higher noise immunity for 24V logic signals.**

### 3.4.2.2 Digital outputs

When the digital outputs are shorted the 24V output will continue to operate with a current capability of 50mA. This is so that the CSTOP line does not go low and shut down the drive. If it is important that the drive continues running with a shorted digital output then a digital output set permanently high may be used as an auxiliary 24V power output for other tasks, allowing the main 24V output to be devoted entirely to the CSTOP function.

The current capability of the digital outputs is also an important issue. Typically 50mA is a sufficient specification. However occasionally higher output current is required. The PL/X series addresses this by allowing a total current limit to be made available to all the digital outputs, allowing the user to exploit it as desired. For all 7 outputs together there is a maximum allowable limit of 350mA. Any one output is allowed to output up to 350mA. Any spare capacity within this limit is also available to the 24V output, which also has its own 50mA capability, giving a maximum total to the +24V output of 400mA if no digital output is being used.

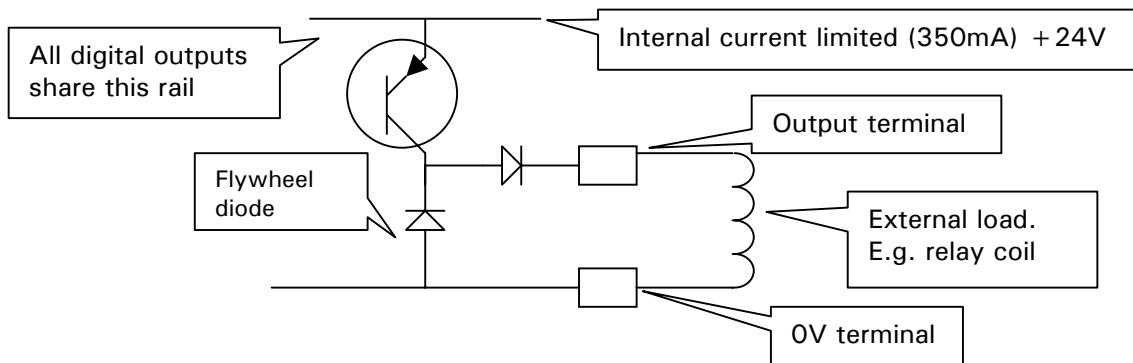

This shows the output configuration for each digital output DOP1 to DOP3 and DIO1 to DIO4

The digital outputs are also designed to be OR'd together, or with outputs from other drives if desired. This is sometimes useful if an external event must wait for several outputs to go low. Each output is fitted with a flywheel diode to allow the safe driving of inductive loads, and because of the current limiting it is possible to drive lamps that may have a low cold resistance.

### 3.4.3 Analogue inputs

#### UIP2 to UIP9

The analogue inputs are required to accurately measure  $\pm 10V$  signals. The resolution (minimum recognisable steps) must be as small as possible and the conversion to a number must be as fast as possible to give good response times. The PL/X series not only possesses 8 analogue inputs, but also measures all of these with up to 5mV plus sign resolution and with excellent response time. In addition it is possible to programme the voltage range of each input to  $\pm 5$ , 10, 20 or 30V. This allows signals other than 10V full scale to be used, and enables the input to be used as a sophisticated digital input. This can be achieved by programming the input to the 30V range and setting the programmable threshold detector at 15V to recognise a 0 or 1. All the analogue input voltages can be monitored using the built in menus, which will display in the selected ranges of  $\pm 5.120V$ ,  $\pm 10.240V$ ,  $\pm 20.480V$  and  $\pm 30.720V$  Volts.

See 6.7.7.7 SPEED PI ADAPTION / Using small speed inputs. The default gives low gain for small inputs.

**Note. When used as digital inputs the UIPs provide excellent noise immunity and settable threshold.**

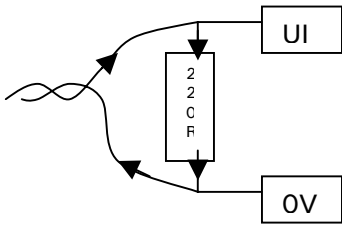

When using 4-20mA loop signals all that is required is to fit an external burden resistor of 220 Ohms between the input and 0V. Then set up the relevant UIP to read the resulting voltage signal generated by passing the signal current through the burden. The diagram shows a 4-20mA signal flowing through an external burden resistor.

See 13.3.1.2.1 4-20mA loop input SETUP

3.4.4 Analogue tachogenerator input

This input is intended solely for the connection of an analogue bi-polar DC tachogenerator. An AC tachogenerator with a rectified output may also be used with the PL series 2 quadrant drives. Terminals T25 0V and T26 TACH should be used for the two connections to the tachogenerator. A DC voltage of up to +/- 200V DC maximum can be applied directly to T26 with respect to T25.

See 6.1.9 CALIBRATION / Speed feedback type PIN 9 QUICK START, to select tach feedback, and 6.1.8 CALIBRATION / Max tach volts PIN 8, to match the 100% feedback voltage and sign on T26.

For forward motor rotation corresponding to a positive reference signal, the tachogenerator feedback voltage sign at terminal T26 with respect to T25 (0V) must correspond to the sign selected in the calibration menu.

The programming facility allows selection of feedback voltages down to 0V, however it is not advisable in the interest of accuracy and smooth operation to use tachos with a voltage less than 10V at full speed.

3.4.5 Signal test pins

There is a row of test pins just behind the middle control terminal used to monitor certain feedback signals.

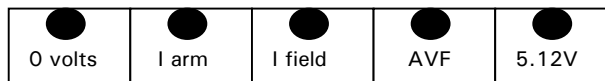

The I arm signal is an attenuated unfiltered inverted version of terminal 29, and may be used to observe the current response of the PL/X. See 13.13.3 DRIVE PERSONALITY / Maximum current response PIN 678.

See 13.4.1 ANALOG OUTPUTS / AOP4 I arm output rectify enable PIN 250.

Signal sign and amplitude is 0 to +/- 2V linear output for 0 to +/- 100% model rating current (inverted) for unrectified mode, or 0 to -2V linear output for 0 to +/- 100% model rating current for rectified mode.

The other signals are intended for factory use only.

3.5 Control terminal default functions

When the drive is shipped the control terminals are allocated with default functions. These are chosen to be as generally useful as possible in most applications. **All the programmable terminals are available to be re-allocated to an alternative function by the user if desired.**

This is a list of the default functions. Note if after programming you wish to return the drive to this default function set up, then arrange to have all 4-menu keys depressed simultaneously during the application of control power. See 5.1.3 Restoring the drive parameters to the default condition, and see 13.13.2 DRIVE PERSONALITY / Recipe page PIN 677.

<b>0V terminal</b>		<b>0V</b>	<b>T1</b>
<b>Aux. Speed Reference</b>	<b>Analogue Input</b>	<b>UIP2</b>	<b>T2</b>
0 to +/-10V linear input for 0 to +/-100% speed. Overvoltage protected to +/-50V. Input impedance 100K.			
<b>Speed Reference/Current demand</b>	<b>Analogue Input</b>	<b>UIP3</b>	<b>T3</b>
0 to +/-10V linear input for 0 to +/-100% speed. Overvoltage protected to +/-50V. Input impedance 100K. (Note, this analogue input is sampled faster than the others for very rapid response applications. E. g. as a current reference. See 6.7.1 SPEED CONTROL / Block diagram).			
See 6.7.7.7 SPEED PI ADAPTION / Using small speed inputs. The default gives low gain for small inputs.			

**Ramped Speed Reference**

0 to +/-10V linear input for 0 to +/-100% speed. Overvoltage protected to +/-50V. Input impedance 100K. This input is routed through a programmable up/down ramp.

See 6.7.7.7 SPEED PI ADAPTION / Using small speed inputs. The default gives low gain for small inputs.

**Analogue Input**      **UIP4**    **T4**

**Lower Current Clamp (-ve)**

0 to -10V linear input for 0 to -100% armature current clamp level. Overvoltage protected to +/-50V. Input impedance 100K. Note. When negative, it operates as a clamp on the current demand generated by the speed loop. When positive it drives the demand and ignores the speed loop. Note a demand level cannot override a clamp level. See also T21.

**Analogue Input**      **UIP5**    **T5**

**Main Current Limit/ Upper Current Clamp (+ve)**

0 to +10V linear input for 0 to +100% armature current clamp level. Overvoltage protected to +/-50V. Input impedance 100K. Note. When positive, it operates as a clamp on the current demand generated by the speed loop. When negative, it drives the demand and ignores the speed loop. Note a demand level cannot override a clamp level. See also T21.

**Analogue Input**      **UIP6**    **T6**

**Motorised pot simulator, preset value enable**

While this terminal is held high the motorised pot simulator is moved immediately to 0.00%. (default preset value). When it is taken low the motorised pot simulator output moves according to the Increase/Decrease inputs on terminals T8/T9.

**Digital Input**              **UIP7**    **T7**

**Motorised pot simulator, Increase**

**Digital input**              **UIP8**    **T8**

**Motorised pot simulator, Decrease**

**Digital input**              **UIP9**    **T9**

**Speed Feedback**

0 to +/-10V linear output for 0 to +/-100% speed feedback. Output current capability 5mA max. Short circuit protection to 0V. (AOP1 or 2 or 3, must not be simultaneously shorted to 0V). Programmable Uni-polar or Bi-polar output mode.

**Analogue Output**      **AOP1**    **T10**

**Total Speed Reference**

0 to +/-10V linear output for 0 to +/-100% total speed reference. Output current capability +/-5mA max. Short circuit protection to 0V. (AOP1 or 2 or 3 must not be simultaneously shorted to 0V).

**Analogue Output**      **AOP2**    **T11**

**Total current demand**

0 to +/-10V linear output for 0 to +/-100% current demand. Output current capability +/-5mA max. Short circuit protection to 0V. (AOP1 or 2 or 3 must not be simultaneously shorted to 0V). Programmable Unipolar or Bi-polar output mode.

**Analogue output**      **AOP3**    **T12**

**0V on T13 must be used for protective clean earth connection**

**0V**      **T13**

**Spare input**

Logic low below 2V, high above 4V

**Digital input**              **DIP1**    **T14**

**Marker input**

Logic low below 2V, high above 4V

**Digital input**              **DIP2**    **T15**

**Encoder (B train or sign)**

Logic low below 2V, high above 4V

**Digital input**              **DIP3**    **T16**

**Encoder (A train)**

Logic low below 2V, high above 4V

**Digital input**              **DIP4**    **T17**

**Zero reference interlock**

This input selects an interlock that will prevent the main contactor from energising if the speed reference is not first returned to less than the 117) ZERO INTLCK SPD % setting.

**Digital input**              **DIO1**    **T18**

**Jog mode select**

When low, jog/slack speed 1 is selected. When high, jog/slack speed 2 is selected.

**Digital input**              **DIO2**    **T19**

**Ramp Hold**

If the input is high, the RUN MODE RAMP output is held at the last value irrespective of the Ramped Reference Input. When low, the output follows the ramped reference input with a ramp time determined by the FORWARD up/down and REVERSE up/down ramp time parameters.

**Digital input**              **DIO3**    **T20**

**Dual Current Clamp Enable****Digital input****DIO4 T21**

This input alters the configuration of the current clamps. When the input is low, Analogue input T6 provides a symmetric bi-polar current limit. When high, analogue input T6 is the positive current clamp and analogue input T5 is the negative current clamp.

**Zero speed****Digital Output****DOP1 T22**

The operating level of this output can be modified by 117) ZERO INTLK SPD % to give the desired speed threshold of operation. A high output +24V indicates Zero speed.

**Ramping flag****Digital Output****DOP2 T23**

This goes high when the Run Mode Ramp is ramping. (Used to prevent speed loop integration during ramp).

**Drive healthy****Digital Output****DOP3 T24**

This output is high when the controller is healthy. This means that no alarms have tripped and the drive is ready to run.

**0V terminal****0V T25****DC Tachogenerator Input****TACH T26**

Full speed setting range +/-10V to +/-200V. Input impedance 150K Ohms. Signal range 0V to +/-200V.

**User +10V Reference****+10V T27****User -10V Reference****-10V T28**

+/-10.00V, 0.5%, 10mA max. Short circuit protection to 0V

**Armature Current Output****IARM T29**

0 to +/-5V linear output for 0 to +/-100% **model** current. Output current capability +/-10mA max. Short circuit protection to 0V. Programmable Uni-polar or Bi-polar output mode.

**Motor thermistor input****THM T30**

It is good practice to protect DC motors against sustained thermal overloads by fitting temperature sensitive resistors or switches in the field and interpole windings of the machine. These devices have a low resistance (typically 200 Ohm) up to a reference temperature 125 C. Above this temperature, their resistance rises rapidly to greater than 2000 Ohms. Motor over-temperature sensors should be connected in series between terminals T30 and T36. A motor over-temperature alarm will be displayed if the external resistance between T30 and T36 exceeds 1800 Ohms  $\pm$  200 Ohms. See 8.1.11.6 DRIVE TRIP MESSAGE / Thermistor on T30. **Terminals T30 and T36 (0V COM) must be linked if external over-temperature sensors are not used.**

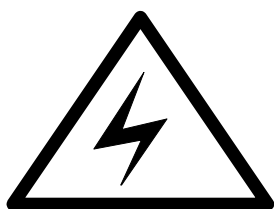
**3.5.1 Run, Jog, Start, Cstop****Run****Digital input RUN T31**

The RUN Input provides a means of electronically inhibiting controller operation. If the RUN input is low, all control loops will be inhibited and the motor stops. RUN also controls the field. See 6.9 CHANGE PARAMETERS / FIELD CONTROL. If the contactor is being held in by a) The zero speed detector while the motor is decelerating or b) The contactor drop out delay, then this will be terminated by RUN going low and will result in immediate contactor drop out. (The RUN input terminal may also be used as a programmable digital input if it is not required as a RUN function)

**WARNING.** Do not rely on any drive function to prevent the motor from operating when personnel are undertaking maintenance, or when machine guards are open. Electronic control is not accepted by safety codes to be the sole means of inhibition of the controller. Always isolate the power source before working on the drive or the motor or load.

If the RUN input goes low at any point during the stopping process, either heading for zero speed or during the delay period, then the contactor will drop out straight away.

**Jog** **Digital input JOG T32**

When the Jog Input is held high the drive jogs (rotates slowly while requested to), provided input Start T33 is low. When the Jog Input is removed the drive will ramp down to zero obeying the Jog/Slack Ramp time. Jog speeds can be selected by input T19. See the description of the start input below for further information about the jog control. See 6.3.5 JOG CRAWL SLACK / Jog mode select PIN 42.

**Start/stop main contactor control** **Digital input START T33**

When a high input is applied to this terminal the controller will operate provided there are no alarms, the coast stop input (T34) is already high, the controller run input (T31) is high and the Jog input is low. When the input is removed the controller will perform a ramped stop to zero speed. The rate of deceleration will be set according to the programmed stop ramp time. The PLX models will regenerate if necessary to maintain the ramp rate. So will the PL models that have the electronic stopping facility. The PL models that do not have this facility will not be able to decelerate faster than the natural coast down rate. For all models, when the motor has reached zero speed, then the main contactor will de-energise.

See 6.3.5 JOG CRAWL SLACK / Jog mode select PIN 42

Note. The user control input contact must be maintained using external interlocking relay logic, or LAT1/2 on terminals 47 and 48. See 4.3.4 Using pushbuttons for simple STOP / START.

See 4.3.5 Using pushbuttons for STOP / START (With ramp to stop, jog and slack take up).

The Start and Jog inputs provide the following operating features

- a) Normal running
- b) Jogging with 2 selectable jog speeds and programmable contactor drop out delay
- c) Crawling. The crawl speed is a programmable parameter
- d) Slack take up with 2 selectable take up speeds

With start high and jog low, then jog going high acts as a slack take up. With start low the jog input is a jog control. The jog/slack speed 2 select input is on T19 (Jog mode select).

With jog low and mode select high, then start going high acts as the crawl control. See 6.3.5 JOG CRAWL SLACK / Jog mode select PIN 42

The crawl uses the run mode ramp times to accelerate, and the Stop mode ramp times to stop.

**Coast stop main contactor control** **Digital input CSTOP T34**

With a high input, the controller operates normally. When the Coast Stop is at zero volts or open circuit, the main contactor is open and the drive no longer operates. If this input drops low during running then the main contactor will de-energise within 100mS and the motor will coast to rest under the influence of external factors e.g. friction and inertia, or by using an external dynamic braking resistor to dissipate the rotational energy. **Note. The CSTOP must be high for at least 50mS prior to START going high.**

Note. When the digital outputs are shorted the 24V output will continue to operate with a current capability of 50mA. This is so that the CSTOP line does not go low and shut down the drive. If it is important that the drive continues running with a shorted digital output then a digital output set permanently high may be used as an auxiliary 24V power output for other tasks, allowing the main 24V output to be devoted entirely to the CSTOP function.

**+ 24V Supply (22V to 32V)** **Output + 24V T35**  
 + 24V output for external logic. Short circuit protected with fault annunciation. Overvoltage protection to + 50V. See 3.4.2 Digital inputs and outputs.

**OV terminal** **OV T36**

**Control terminals on lower power board numbers 41 to 53. Not programmable.**

**Remote AVF positive input from motor armature** **RA+ T41**

RA+ RA- used for remote armature volts sensing. **(Automatic internal disconnection)** If a DC contactor is used with field weakening, it allows the field control circuit to continue to sense the back emf of the motor after the contactor has opened and hence prevent a sudden dangerous strengthening of the field current. (Note, the AVF is increased by 3.3% when using remote sensing, this causes a -3.3% speed scale change).

**Unconnected terminal. Leave this terminal free of connections.** **NC T42**

<b>Remote AVF negative input from motor armature See T41</b>	<b>RA-</b>	<b>T43</b>
<b>Unconnected terminal. Leave this terminal free of connections.</b>	<b>NC</b>	<b>T44</b>
<b>Volt free contact for main contactor coil.</b>	<b>Rating up to 240V 500VA.</b>	<b>CON1 T45</b>
		<b>CON2 T46</b>
<b>Volt free contact for latching contactor push button. Rating up to 240V 500VA.</b>		<b>LAT1 T47</b>
<b>See 4.3.4 Using pushbuttons for simple STOP / START (Coast to stop)</b>		<b>LAT2 T48</b>
<b>EARTH on 51 is a dirty earth connection to the control supply</b>	<b>EARTH</b>	<b>T51</b>
<b>L and N is for control power 100-240V 50/60Hz +/-10% 50VA</b>	<b>N</b>	<b>T52</b>
	<b>L</b>	<b>T53</b>

If the voltage falls below 80V AC the unit will commence an orderly shutdown sequence.  
See 3.6 Supply loss shutdown.

### 3.5.2 Summary of default terminal functions

OV terminal		OV	T1
Aux Speed Reference	Analogue Input	UIP2	T2
Speed Reference/Current Demand	Analogue Input	UIP3	T3
Ramped Speed Reference	Analogue Input	UIP4	T4
Lower Current Clamp (-ve)	Analogue Input	UIP5	T5
Main Cur Limit/ Upper Current Clamp (+ ve)	Analogue Input	UIP6	T6
Motorised pot simulator, preset enable	Digital Input	UIP7	T7
Motorised pot simulator, Increase	Digital Input	UIP8	T8
Motorised pot simulator, Decrease	Digital Input	UIP9	T9
Speed feedback	Analogue Output	AOP1	T10
Total speed reference	Analogue Output	AOP2	T11
Total current demand	Analogue Output	AOP3	T12
OV terminal. Protective clean earth connected here.		OV	T13
Spare input	Digital Input	DIP1	T14
Marker input	Digital Input	DIP2	T15
Encoder (B train or sign)	Digital Input	DIP3	T16
Encoder (A train)	Digital Input	DIP4	T17
Zero reference interlock	Digital Input	DIO1	T18
Jog mode select	Digital Input	DIO2	T19
Ramp hold	Digital Input	DIO3	T20
Dual current clamp enable	Digital Input	DIO4	T21
Zero speed	Digital Output	DOP1	T22
Ramping flag	Digital Output	DOP2	T23
Drive healthy	Digital Output	DOP3	T24
OV terminal.		OV	T25
DC Tachogenerator input		TACH	T26
User +10V reference		+10V	T27
User -10V reference		-10V	T28
Armature current output		IARM	T29
Motor thermistor input		THM	T30
Run	Digital Input	RUN	T31
Jog	Digital Input	JOG	T32
Start/stop contactor control	Digital Input	START	T33
Coast stop contactor control	Digital Input	CSTOP	T34
+24V Supply	Output	+24V	T35
OV terminal		OV	T36

### 3.6 Supply loss shutdown

There are 3 supply ports to the unit.

Port 1) Control supply. 1ph. Provides power for the internal control electronics.

Port 2) EL1/2/3 Auxiliary supply 3ph. Provides power for the field and is used for synchronisation.

Port 3) L1/2/3 Main supply 3ph. Provides power for the armature bridge.

A loss of any line on port 3, will be recognised by the missing pulse detector.

A loss of any line on port 2, will be recognised by either field loss (EL3), phase loss (EL1/2), or synchronisation loss (EL1/2) detectors. (Note. Ports 2 and 3 are ultimately fed from the same supply, although via different fuses, or step up/down transformers).

Hence a supply loss may simultaneously be recognised by port 2 and port 3.

A total supply loss to the installation will occur on all 3 ports simultaneously.

See 8.1.11 MOTOR DRIVE ALARMS / DRIVE TRIP MESSAGE.

A loss on port 1 will be recognised below approx. 80V AC.

See also 9.1.10 SELF TEST MESSAGE / Internal error code, for details of dips on port 1.

Effects of supply loss or dips.

The armature and field current will phase back to zero, the contactor control will de-energise. Any valid trip message is permanently saved. See also 5.1.2 PARAMETER SAVE.

In the case of a supply dip, the message INTERNAL ERROR CODE / SUPPLY PHASE LOSS will appear on the display to indicate that a supply DIP has occurred. Press the left key to reset. This message may be briefly visible at normal control supply turn off.

See 8.1.11.11 DRIVE TRIP MESSAGE / Supply phase loss, for details on ride through times.



## 4 Basic application

<b>4 Basic application .....</b>	<b>33</b>
4.1 Basic speed or torque control .....	34
4.2 Main Contactor operation .....	35
4.2.1 Contactor control questions and answers .....	35
4.3 Main contactor wiring options .....	37
4.3.1 Main contactor isolating AC stack supply .....	37
4.3.2 Main contactor isolating AC stack and auxiliary supplies .....	37
4.3.3 Main contactor isolating DC armature .....	38
4.3.4 Using pushbuttons for simple STOP / START (Coast to stop) .....	39
4.3.5 Using pushbuttons for STOP / START (With ramp to stop, jog and slack take up) .....	40
4.4 ESSENTIAL pre-start checks .....	41
4.4.1 POWER ENGINEERING .....	41
4.4.2 MECHANICAL ENGINEERING .....	41
4.5 CONTROL ENGINEERING COMMISSIONING PROCEDURES .....	42
4.5.1 Quick start calibration.....	42
4.5.2 Quick start calibration step by step .....	43
4.5.3 Quick start current loop AUTOTUNE.....	43
4.5.4 PASSIVE MOTOR defaults / Using passive motor menu for small test motors .....	44

### Overview of initial commissioning procedure

**Always check safety systems thoroughly and observe local safety codes.**

The suggested strategy is to start in the safest possible mode of operation and progressively exercise each element of the system until full functionality has been achieved.

This chapter is a step by step approach up to 4 in this list.

- 1) Check installation and supplies. (**L1/2/3**, **EL1/2/3** and **control supply**) and all **safety systems**.
- 2) Calibrate PL/X to match motor. (Use Armature voltage feedback below base speed for first run). (Save calibration parameters)
- 3) Insert firebar (electric heating element, high wattage resistor, e.g. 4 Ohms 1Kw) in series with armature and check operation of contactor and field.
- 4) Remove firebar, perform AUTOTUNE and run motor up to base speed. Check operation of feedback transducers and mechanical components.
- 5) Introduce tacho or encoder feedback and proceed to field weakening if required.
- 6) Start implementing more complex applications blocks.
- 7) **Check safety systems thoroughly and observe local safety codes.**

**INCORRECT CONTROL OF THE MAIN CONTACTOR IS THE MOST COMMON FORM OF PROBLEM. PLEASE SEE SECTIONS 4.2 and 4.2.1 FOR FURTHER HELP.**

### 4.1 Basic speed or torque control

This section shows the essential requirements for a very basic speed or torque control application.

Note that the arrangement of the contactor shown here allows continuous phase sensing on EL1/2/3.

**VERY IMPORTANT** see 4.2 Main Contactor operation, 4.3 Main contactor wiring options, 14 Installation.

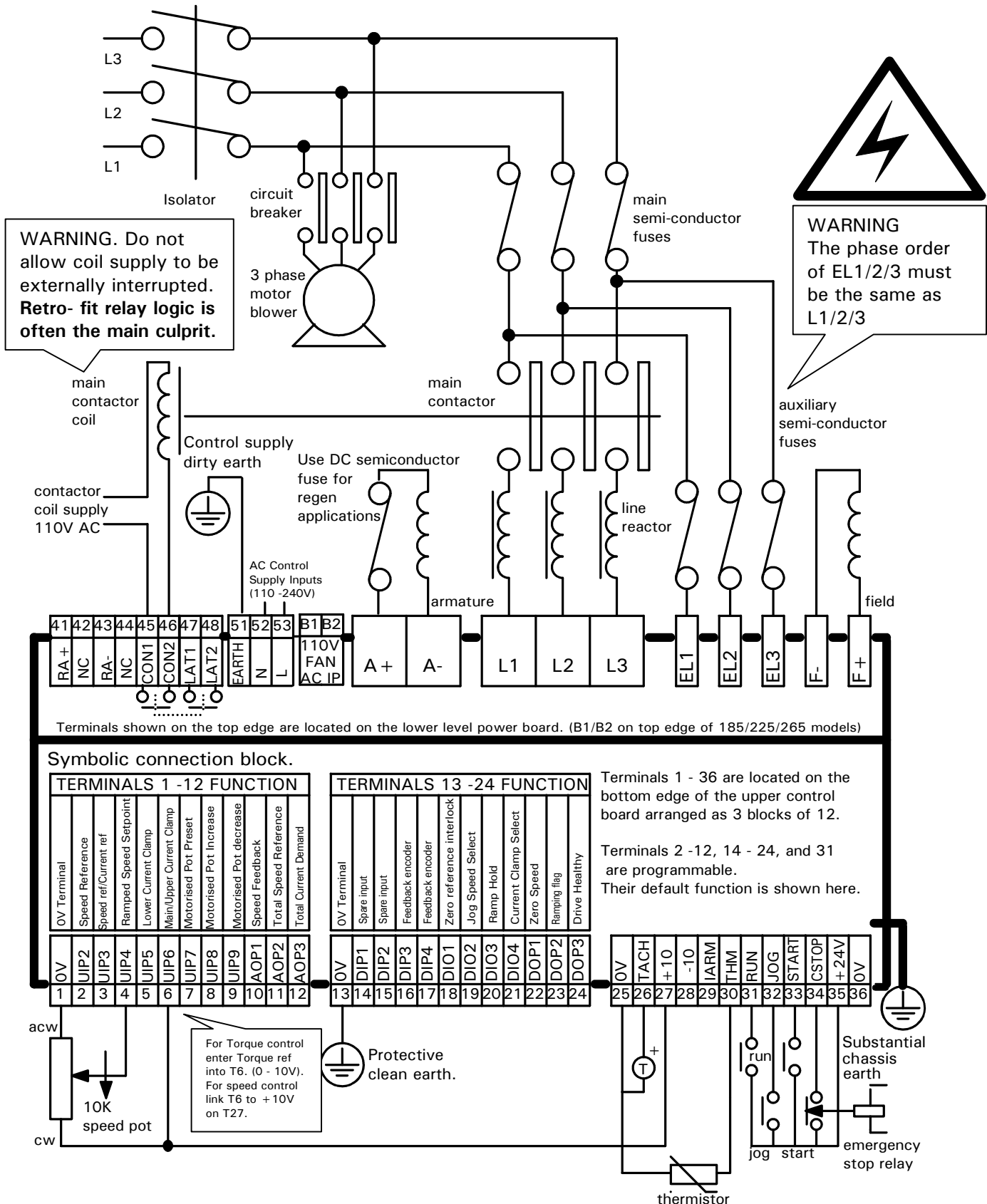

## 4.2 Main Contactor operation

The control of the main contactor is very important. Incorrect implementation is the main cause of failures. See also 6.5 CHANGE PARAMETERS / STOP MODE RAMP and 6.5.1.1 Block diagram of contactor control.

The essential elements of controlling the contactor are as follows.

- 1) It must be possible to release the contactor without relying on electronics.
- 2) The contactor must not break current. To obey this rule the following applies:-
  - a) The PL/X must not attempt to deliver armature current until after the contactor has closed.
  - b) The armature current must be brought to zero before the contactor has opened.
- 3) The contactor control circuit must be compatible with all likely application requirements.

The PL/X has been designed to control all of the above requirements in the use of the main contactor.

The purpose of the main contactor is to provide mechanical isolation of the motor armature from the power supply. In the event of an emergency it must be possible for the supply to be removed electromechanically (without the aid of semiconductor electronics). This requirement is usually mandated by safety codes.

Under normal operation the contactor is controlled by the PL/X according to the programmed requirements of the user. See 6.5 CHANGE PARAMETERS / STOP MODE RAMP. The CSTOP (coast stop) terminal T34 goes directly to the 24V coil of the internal contactor control relay. (Relay contact is on T45 and T46). If this terminal is provided with 24V then the relay (and hence the main contactor) is ready to be controlled by the PL/X. If the CSTOP terminal is opened then the relay will either not energise, or de-energise and release the main contactor. There is a capacitor across the relay coil which causes it to have a defined drop out time of approx. 100mS. This ensures that the PL/X has time to commutate the armature current to zero before the contacts open.

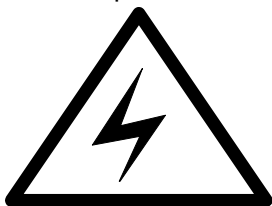

It may be necessary for installations to have over-riding external independent systems for de-energising the main contactor. In this case it is recommended that the CSTOP terminal be opened 100mS in advance of the main contacts opening. Failure to achieve this may result in damage to the unit.

**Note.** If the users main contactor has a closing time delay of greater than 75mS, then it is essential that steps are taken to delay the release of armature current until the main contact has closed.

- 1) Insert an auxiliary normally open contact on the main contactor in series with the RUN input on T31.
- 2) Alternatively use contactor wiring method shown in 4.3.2.

Contactor coils usually have a high inductance. When the contactor is de-energised it can produce high energy arcing on the internal PL/X control relay. This may degrade the life of the relay and/or produce excessive EMC emissions. Ensure that the contactor coil is snubbed.

### 4.2.1 Contactor control questions and answers

**Question.** Why is it so important to prevent the contactor 1) Breaking current or 2) Making current?

**Answer.** 1) Breaking current. The motor armature is an inductive load. This helps to smooth the current by storing electrical energy during a charging period and releasing it during a discharging period. However if the circuit is suddenly broken then the stored energy has nowhere to go. This results in a rapid rise in voltage as the inductor (motor armature) seeks to find a discharge path. This rapid transient may cause thyristors in the armature bridge to avalanche on and become conductive. If this happens to a pair of thyristors then an effective short circuit may be formed across the armature. Then a second effect occurs. If the motor is rotating and is suddenly shorted then the mechanical energy stored in the rotation of the motor and load is then generated into the short circuit. This could be a destructive amount of energy. The thyristors then become permanently shorted, and the next time that the contactor closes, the supply fuses will blow.

#### **Solution.**

Always let the PL/X control the contactor. It has been designed to hold the contactor in while it safely quenches the armature current. Use the CSTOP for emergency opening of the contactor via the PL/X. This terminal is electromechanical but also lets the PL/X quench the current in time. If safety codes prevent the PL/X from being used in the emergency stop sequence, ensure that the CSTOP is opened 100mS prior to the main contactor opening.

**Answer.** 2) Making current. If the PL/X has been instructed to start making current, but the main contactor has not yet closed, then the motor will not be able to rotate. This will cause the PL/X to phase further forward in an attempt to produce the desired speed. If the contactor then closes it will present a stationary motor armature on a fully phased forward stack, straight on to the supply, producing destructive current. All this will occur in a few cycles of current which is far too fast for the speed loss alarms to operate.

**Solution.**

- 1) Insert an auxiliary normally open contact on the main contactor in series with the RUN input on T31.
- 2) Alternatively use contactor wiring method shown in 4.3.2.

**Question.** Plenty of systems do not appear to suffer from failures due to opening the contactor incorrectly so why is it so important?

**Answer.** If the armature current is discontinuous, which is very common, then there is much less stored inductive energy and the current also goes to zero every current cycle. This makes it highly unlikely that a destructive situation occurs. The high risk situations are regenerative applications and continuous current modes. Even in these cases it does not always result in a destructive sequence.

**Question.** Even if the contactor operates according to the recommendations how is protection afforded if the contactor coil supply is lost.

**Answer.** This is a difficult problem to solve using electronics. The only reliable insurance is to insert a DC semiconductor fuse in the armature circuit. This fuse should open before the thyristor junction fails.

**Question.** What if the grid system fails totally?

**Answer.** This is not as bad as losing the contactor coil supply. Most installations naturally have other loads that provide a safe discharge path before the contactor opens.

**Question.** What if the grid system fails for a few cycles? (Brown outs)

**Answer.** The PL/X is designed to ride through these kinds of supply dips. As soon as it loses synchronisation the armature current is quenched. The armature voltage is then monitored so that when the supply returns the PL/X picks up into the rotating load at the correct speed.

**Question.** What other sorts of problems occur?

**Answer.** Most problems occur when users are retro-fitting the PL/X into an existing system. Sometimes these systems have previously controlled the contactor via a PLC or Drive healthy relay. These control systems may not be interfaced correctly with PL/X and situations occur that drop out the contactor too quickly, or bring it in too late.

Another common problem is that the contactor is controlled correctly for normal running but incorrectly during jogging or emergency stopping.

Another instance is the installation is designed correctly but the commissioning engineer uses a local op station to get each PL/X going, that has an in built control problem.

**Summary.** Use the PL/X to control the main contactor for STOP, START, jogging and emergency stop. All sequencing occurs automatically. Fit semiconductor fuses in the AC supply and armature circuits.

The cost of a fuse is marginal compared to the cost of repairing a damaged drive and suffering machine downtime and engineer call out costs.

### 4.3 Main contactor wiring options

There are various ways of implementing contactor control. Each method has advantages and disadvantages. Please study the rest of this section carefully before choosing the control method.

See also 14.9.1 Wiring diagram for AC supply to L1/2/3 different to EL1/2/3. (E.g. Low voltage field)

#### 4.3.1 Main contactor isolating AC stack supply

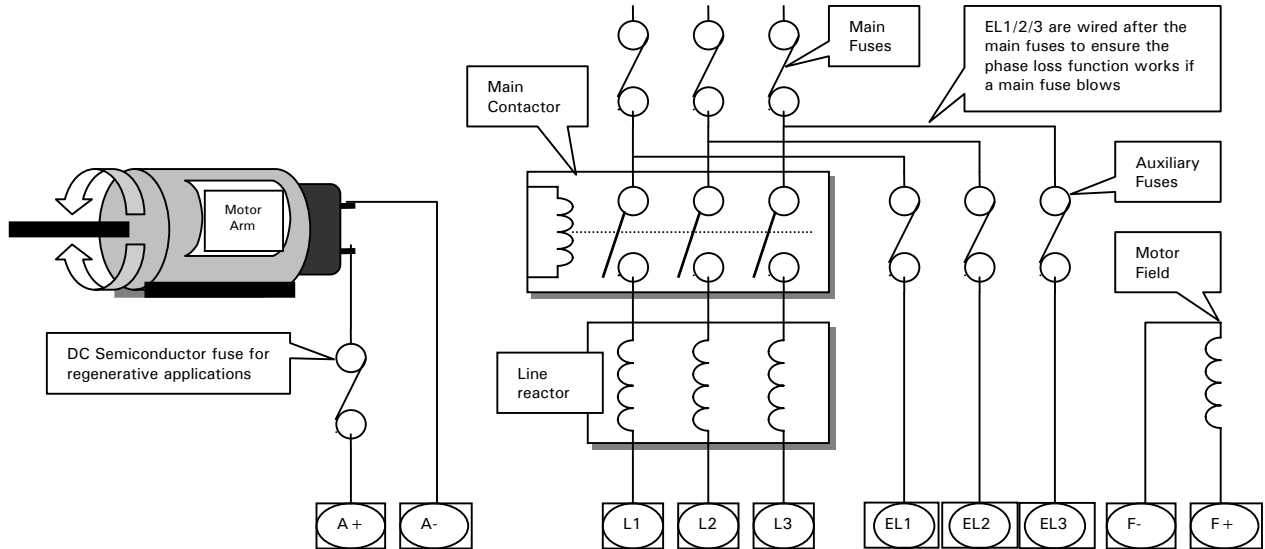

**Advantages** The auxiliary supplies are permanently energised. This allows the synchronisation circuits to lock onto the supply prior to the application of power to the motor. This results in a fast release of current to the armature because it avoids the synchronisation delay. Also the field can remain energised after contactor drop out, allowing dynamic braking and/or condensation prevention in standby field mode.

**Disadvantages** The field winding is not electromechanically isolated by the main contactor, which may contravene safety codes without additional measures. The field standby level may not be set to a low enough level by the user and could cause overheating of the field winding. Phase forward may occur before contactor has closed causing fault current. (Time delay from START command to phase forward is 75mS.)

#### 4.3.2 Main contactor isolating AC stack and auxiliary supplies

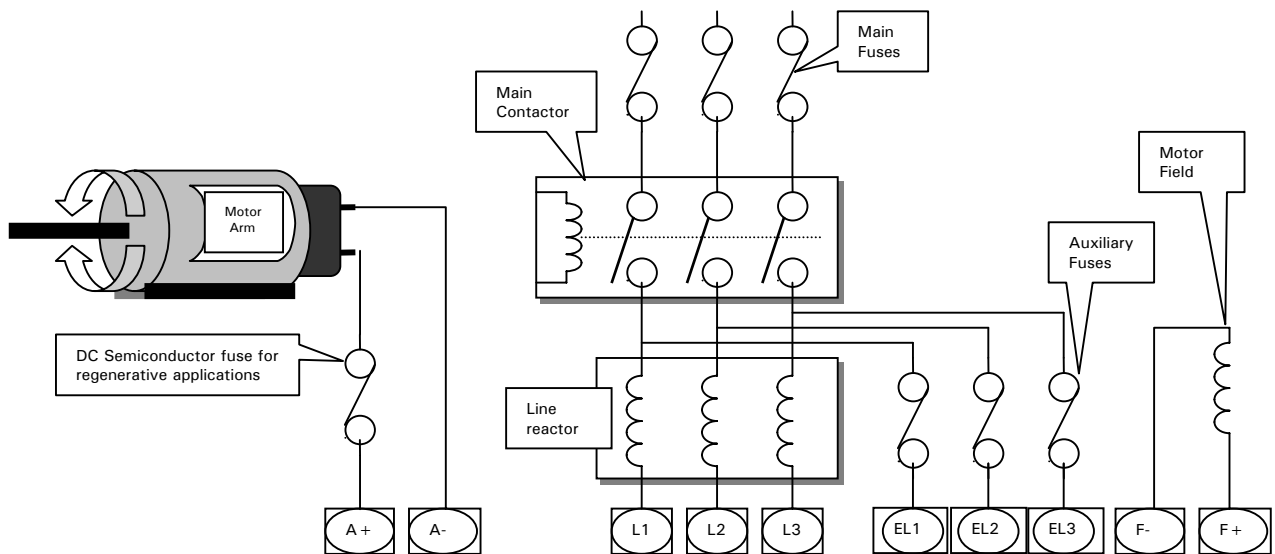

**Advantages** The field winding is electromechanically isolated by the main contactor. Some retro fit installations are only able to provide the 3 main phases because the main contactor is remotely located to the drive panel, in which case this wiring method may be preferred.

The PL/X cannot phase forward until the contactor has closed because EL1/2/3 take time to synchronise.

**Disadvantages** The auxiliary supplies are de-energised by the main contactor. This causes a turn on delay of approximately 0.75 secs while the synchronisation circuits establish a lock onto the supply prior to the application of power to the motor. Also the field cannot remain energised after contactor drop out which prohibits dynamic braking and/or condensation prevention in standby field mode.

#### 4.3.3 Main contactor isolating DC armature

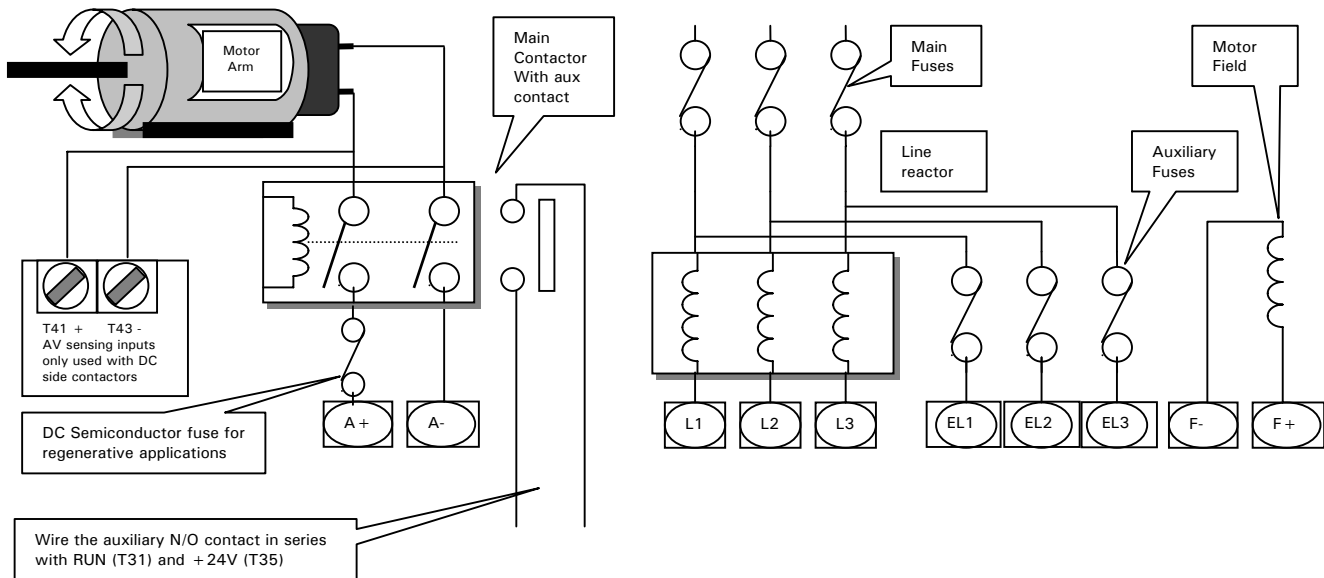

**Advantages** The auxiliary supplies are permanently energised. This allows the synchronisation circuits to lock onto the supply prior to the application of power to the motor. This results in a fast release of current to the armature because it avoids the synchronisation delay. Also the field can remain energised after contactor drop out allowing dynamic braking and/or condensation prevention in standby field mode.

**Disadvantages** The field winding is not electromechanically isolated by the main contactor, which may contravene safety codes without additional measures. The field standby level may not be set to a low enough level by the user and could cause overheating of the field winding.

The AC supply is permanently connected to the PL/X unless further provision is made to isolate the supplies.

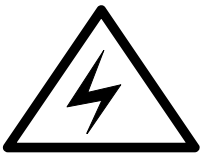

**Note.** The armature must be connected to the remote sense terminals T41 and T43. This ensures that the PL/X can measure the armature voltage even when the contactor is open. It is dangerous to utilise a DC contactor when field weakening is employed without also connecting T41 and T43 to the motor armature.

See also 6.5 CHANGE PARAMETERS / STOP MODE RAMP and 6.5.1.1 Block diagram of contactor control.

4.3.4 Using pushbuttons for simple STOP / START (Coast to stop)

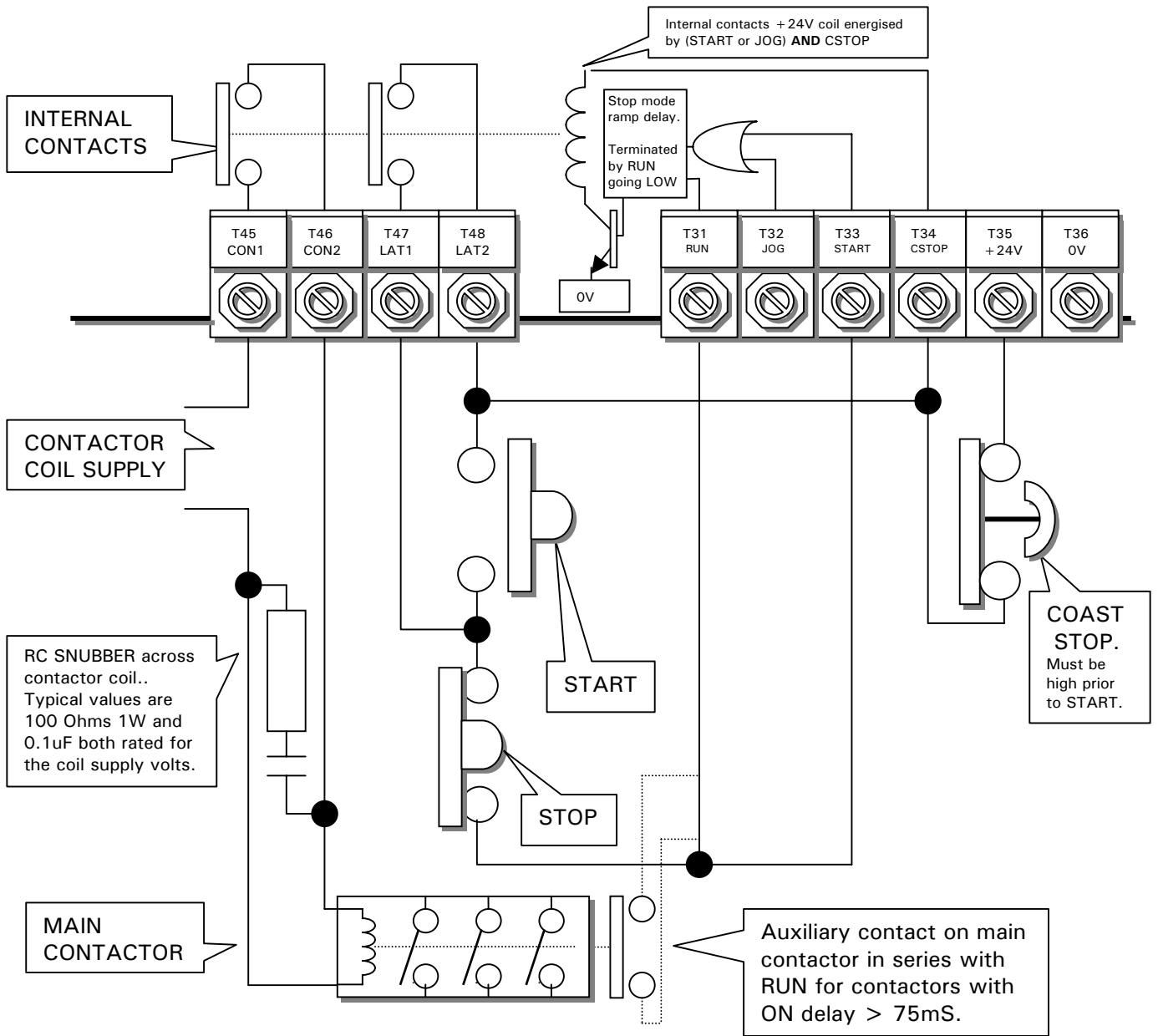

Note. This circuit will cause the contactor to drop out as soon as the STOP button contact is opened because the START input is opened **together with the RUN input**, which over-rides the STOP MODE RAMP function.

When the STOP button opens during running, the main contactor will de-energise within 100mS, and the motor will coast to rest under the influence of external factors e.g. friction and inertia, or by using an external dynamic braking resistor to dissipate the rotational energy.

**Note. The CSTOP must be high for at least 50mS prior to START going high.**

In order to allow regeneration during the stopping sequence an external latching circuit must be employed to control the STOP / START contacts (T47 / 48 cannot be used), and the RUN input is not controlled from the START terminal. See 4.3.5 Using pushbuttons for STOP / START (With ramp to stop, jog and slack take up).

See 6.5 CHANGE PARAMETERS / STOP MODE RAMP.





## 4.4 ESSENTIAL pre-start checks

This is a summary of the essential parameters that should be checked prior to allowing power to the motor. You must be able to put a tick against every section. Failure to comply with these requirements may cause incorrect functioning or damage to the drive and/or installation and will invalidate any warranty.

### 4.4.1 POWER ENGINEERING

You must be able to put a tick against every section.

**1) All external fuses must be of the correct rating and type. The I<sup>2</sup>t rating must be less than the rating specified in the rating tables. This includes main and auxiliary fuses.**

See 14.3 Semiconductor fuse ratings.

2) Check that the motor armature resistance is about 2 Ohms +/-1 over 360 deg rotation. Check that the field resistance in Ohms = (field dataplate volts) / (field dataplate current). Look inside the motor terminal box to verify correct wiring.

**3) Check the 3 phase auxiliary supply phasing on ELI /2/3 equates to the phasing of the main stack supply on LI/2/3, and the 1 ph control supply on T52/53 is correct.**

4) The drive and 3 phase supply current and voltage ratings, should be compatible with the motor and load requirements. (Both armature and field, current and voltage).

5) The cables and termination should be rated to carry the rated current with no more than a 25C temperature rise, and all terminations should be tightened to the correct torque.

See 14.10 Terminal tightening torques.

**6) The main contactor must be operated by the CON1/2 contact on terminals 45 and 46**

7) The wiring should be checked for short circuit faults. AC power to ground, signal and control. DC power to ground, signal and control. Signal to control and ground.

**Disconnect the drive for wiring tests using a megger. (Control terminals are plug in type).**

8) The engineering standards employed must comply with any local, national or international codes in force. Safety requirements take priority.

**9) If the load regenerates or regenerative braking is employed, then a DC rated armature fuse with the correct I<sup>2</sup>t rating in series with the motor armature is highly recommended.**

See 14.3.3 DC semi-conductor fuses.

10) A substantial protective chassis earth connection in accordance with relevant codes should be made to the terminal bar provided at the bottom edge of the unit.

**11) A protective clean earth connection must be made to the control 0V on T13 to ensure that the installation complies with protective class1 requirements.**

### 4.4.2 MECHANICAL ENGINEERING

1) The motor, and load if fitted, must be free to rotate without causing damage or injury, even in the event of incorrect rotation direction, or loss of control.

2) Blow over the commutator using clean dry air to clear it of extraneous matter. Check that the brushes are correctly seated and that the brush tensions are correct.

3) Check that the motor vent blower is free to rotate, and remember to re-check the airflow when the blower is operating.

4) The emergency stopping and safety procedure, including local and remote actuators must be checked prior to applying power to the motor.

5) The installation must be clean and free of debris, swarf, clippings, tools etc. The enclosure must be adequately ventilated with clean dry cool filtered air.

When the motor is running, check the PL/X heatsink fans are operating, and the flow of heatsink air is unobstructed. See 14.1 Product rating table , for cooling airflow data.



checked

checked

checked

checked

checked

checked

checked

checked

checked

checked

checked

checked

checked

checked

checked

checked

## 4.5 CONTROL ENGINEERING COMMISSIONING PROCEDURES

Before applying power to the L1/2/3 terminals for the first time, it is recommended that a high wattage resistor of between 4 and 40 Ohms (**E.g. a 1 Kw fire bar**) is inserted in series with the armature. This will limit any potentially destructive current and prevent possible thyristor damage.

(A typical example of the cause of fault current is the incorrect phasing of the EL/1/2/3 terminals with respect to L1/2/3. Without the correct semi-conductor fuses this may result in thyristor damage on the application of the start command).

(Note. The fire bar will be removed prior to performing the AUTOTUNE procedure as described later).

1) For systems using field weakening, start with the unit calibrated for armature voltage feedback first in order to verify normal operation up to base speed. Then introduce field weakening only after careful calibration, and switching to either tacho or encoder feedback.

2) For systems employing torque control it is recommended to set up in basic speed mode first in order to establish correct speed loop functioning and calibration.

### 4.5.1 Quick start calibration

Assuming that the drive unit is correctly installed and the motor and load are safe and ready to be rotated, then the next task is to calibrate the drive to suit the supply and the motor.

The PL/X series has a method of calibration which avoids the need to solder resistors and set switches. All the fundamental drive scaling parameters can be programmed via the on board display and menu keys.

Once the initial calibration menu is completed the chosen limits may be saved and will remain unaltered unless you wish to re-calibrate. There is also the choice of using a password to prevent unauthorised re-calibration.

The unit automatically knows the model armature current ratings and will prevent setting of armature current in excess of the model rating.

See 13.13.4 DRIVE PERSONALITY / Armature current burden resistance PIN 680.

The parameters that will be selected for quick start calibration are as follows

See 6.1 CHANGE PARAMETERS / CALIBRATION for a full explanation of these parameters

Parameter	Range	Factory default	Entered Units
2)RATED ARMATURE AMPS	33 – 100% of unit rating	33%	Amps
3)CURRENT LIMIT%	0 – 150% of unit rating	150%	%
4)RATED FIELD AMPS	0.1A – 100% of unit rating	25%	Amps
5)BASE RATED RPM	0 - 6000	1500	Revs per minute of motor at maximum armature volts
6)DESIRED MAX RPM	0 - 6000	1500	Max revs per minute of motor at your desired max speed
9)SPEED FEEDBACK TYPE	Armature voltage (select this one) plus 4 other choices	Armature voltage	Armature voltage
18)RATED ARM VOLTS	0 – 600.0 VOLTS DC	460	Volts
19)EL1/2/3 RATED AC	0 to 600.0	415V	Volts AC

By selecting Armature Voltage a quick start is more easily achieved.

- 1) The speed feedback is always present, and in the correct polarity.
- 2) The motor and/or load can be seen to be rotating correctly and at approximately the correct speed.
- 3) If a tachogenerator or encoder is fitted then it can be checked for the correct polarity and output levels prior to including it in the feedback loop.
- 4) Other parameters such as ramp rates and stopping modes can be checked and or set before proceeding to final accurate calibration.
- 5) The system may need pre-test prior to shipping and no tachogenerator is available. For this quick start procedure it is only necessary to set the above parameters.

4.5.2 Quick start calibration step by step

1) Turn on the control supply and press the right key to exit diagnostics for the ENTRY MENU.

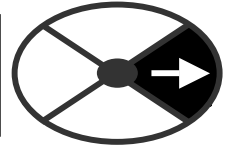

2) Press the right key to enter the ENTRY MENU / CHANGE PARAMETERS window. Press the right key again to enter the CHANGE PARAMETERS / RUN MODE RAMPS menu. Then press the up key for the CHANGE PARAMETERS / CALIBRATION menu. Enter the CALIBRATION menu by pressing the right key. Once there, use the up or down key to travel round the circular menu.)

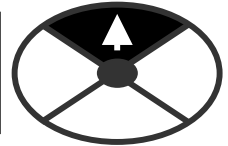
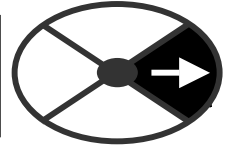

3) Only 8 of the available parameters need to be adjusted for QUICK START. (PINs 2, 3, 4, 5, 6, 9, 18, 19). Skip the other windows.

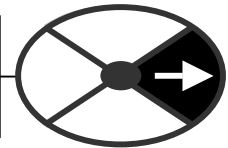

4) Select the quick start parameters by using the up / down keys. Press the right key to enter the parameter adjustment window for each in turn. Modify each one to suit your system using the up/down keys. Use the left key to back out of each parameter adjustment window and return to the circular CALIBRATION menu.

When you have finished modifying the 8 quick start parameters, it is time to save the changes you have made. Use the left key to return to the ENTRY MENU / CHANGE PARAMETERS menu. Use the up key to arrive at ENTRY MENU / PARAMETER SAVE. Use the right key to enter the PARAMETER SAVE window. Use the up key to save the parameters. While the save is taking place the bottom line will read SAVING. When the save is complete the bottom line will read FINISHED. You can now return by holding down the left key. This will take you to the default diagnostics, and then one tap right to the ENTRY MENU.

Note. For a description of the default diagnostics see 5.1.6 Default % DIAGNOSTIC summary windows.

Now the PL/X is calibrated to match your motor it is time to apply 3 phase power for the first time to establish correct functioning of the main contactor and that the field current is correct. Remember that there should be a fire-bar inserted in the armature circuit to protect against fault currents. See 4.2 Main Contactor operation and 7.3 DIAGNOSTICS / FLD I LOOP MONITOR.

Once you have established correct functioning of the main contactor and that the armature and field are receiving power as expected, then you must remove the fire bar in readiness for the quick start procedure.

4.5.3 Quick start current loop AUTOTUNE

5) The next step is to set up the armature current loop response. The unit is provided with an autotune facility that will perform this function automatically. Using the keys go to CHANGE PARAMETERS / CURRENT CONTROL, and then to CURRENT CONTROL / AUTOTUNE ENABLE.

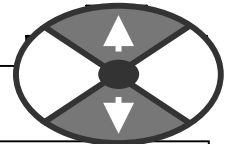
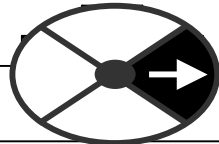

Enables the autotune function to start. It turns itself off.

PARAMETER	RANGE	DEFAULT	PIN
AUTOTUNE ENABLE	ENABLED OR DISABLED	DISABLED	92

Note. The autotune function makes adjustments to the current loop error amplifier PID terms to achieve optimum performance. When ENABLED it will wait until the main contactor is energised, and the drive run, before starting its autotune routine. It may take from a few seconds up to about 1 minute typically. When it has finished it drops out the main contactor, sets the required parameters and then automatically DISABLES itself. You can check that it has finished by looking in the display window and waiting for the DISABLED comment to re-appear on the bottom line. This is a stationary test. There is no need to remove the load.

If the routine is interrupted by a power loss or alarm then the routine is aborted and the old parameter values are left intact. This also occurs after a time out of 2 minutes, which indicates that the load inductance/supply relationship was outside its range of safe operation. In this case you must enter the current loop terms manually. See 6.8.9 CURRENT CONTROL / Autotune enable PIN 92.

6) With the RUN terminal T31 low, activate the Start control and check the operation of the main contactor. If there are any drive problems that are detectable by the on board alarms they will be annunciated. Any alarm conditions must be resolved prior to running. Now take the RUN terminal high to commence AUTOTUNE. Note if a contactor drop out occurs, then the AUTOTUNE will have to be re-enabled before commencing.

7) When you have successfully performed a current loop autotune it is time to save these changes.

8) Provided you correctly adjusted the CALIBRATION parameters, the unit is now calibrated to run in armature voltage feedback mode **with the motor ratings you entered and the current loop tuned.**

9) Activate the Start controls. Slowly increase the speed control potentiometer whilst observing the shaft rotation. If there are any drive problems that are detectable by the on board alarms they will be annunciated. Any alarm conditions must be resolved prior to running. Note it may be necessary to reduce the speed loop gain for smooth running. See 6.7.4 SPEED CONTROL / Speed proportional gain PIN 71.

10) Make use of this quick start mode to check as much of the system as possible prior to further configuration.

#### 4.5.4 PASSIVE MOTOR defaults / Using passive motor menu for small test motors

The PL/X has the facility to be used with 2 different motors. See 6.1.17 CALIBRATION / Motor 1 or 2 select PIN 20. The default values for the **passive motor** (this is motor 2 from the factory) are set at a level to suit very small motors. Making these values the active set during a system test with a small motor, will save time altering and then re-setting the control terms on motor 1.

The dynamic performance of the test motor, **(by making the default passive motor settings the active set)**, will not be as good as a correctly calibrated motor, but should be sufficient for most purposes.

The parameters that have been set at a different default level for the passive motor are as follows.

Paragraph	PARAMETER	Range	Motor 1	Motor 2	PIN
6.1.4	CALIBRATION / Rated field amps PIN 4 QUICK START	0.1 – 100% A	25% Amps	<b>1 amp</b>	4
6.7.4	SPEED CONTROL / Speed proportional gain PIN 71	0 – 200.00	15.00	<b>5.00</b>	71
6.8.2	CURRENT CONTROL / Current clamp scaler PIN 81	0 - 150.00%	150.00%	<b>10.00%</b>	81
6.8.10	CURRENT CONTROL / Current amp proportional gain PIN 93	0 – 200.00	30.00	<b>5.00</b>	93
6.8.11	CURRENT CONTROL / Current amp integral gain PIN 94	0 – 200.00	3.00	<b>1.00</b>	94
6.8.12	CURRENT CONTROL / Discontinuous current point PIN 95	0 – 200.00%	13.00%	<b>0.00%</b>	95

Note. When using very small unloaded motors on high rated PL/X units the missing pulse alarm may be activated. This is because the armature current is below the missing pulse detection threshold. To prevent the alarm from tripping, set 8.1.5 MOTOR DRIVE ALARMS / Missing pulse trip enable PIN 175 to DISABLED.

See also 13.13.4.1 50% / 100% rating select, for details of the burden jumper, which allows selection of a high value burden resistor for an alternative method of testing the PL/X on small motors.

## 5 Menu tree structure

<b>5</b>	<b>Menu tree structure .....</b>	<b>45</b>
5.1	Key functions.....	46
5.1.1	Incrementing and decrementing parameter values.....	47
5.1.2	PARAMETER SAVE .....	47
5.1.3	Restoring the drive parameters to the default condition .....	47
5.1.4	Branch hopping between monitor windows.....	47
5.1.5	Power up windows .....	47
5.1.6	Default % DIAGNOSTIC summary windows .....	48
5.1.7	Finding the software version number of the unit.....	48
5.2	ENTRY MENU .....	48
5.2.1	Full menu diagram (Change parameters).....	49
5.2.2	Full menu diagram (Change parameters continued) .....	50
5.2.3	Full menu diagram (Diagnostics).....	51
5.2.4	Full menu diagram (Motor drive alarms, serial links and display functions).....	52
5.2.5	Full menu diagram (Application blocks and configuration) .....	53
5.2.6	Full menu diagram (Configuration continued).....	54
5.2.7	Full menu diagram (Block OP and Fieldbus configs, Drive personality and Conflict Help).....	55
5.3	Archiving PL/X recipes .....	56

### 5.1 Key functions

The user display has been designed to make programming as simple as possible. 4 keys arranged as up/down and left/right are used to step through the tree structure in their nominated direction.

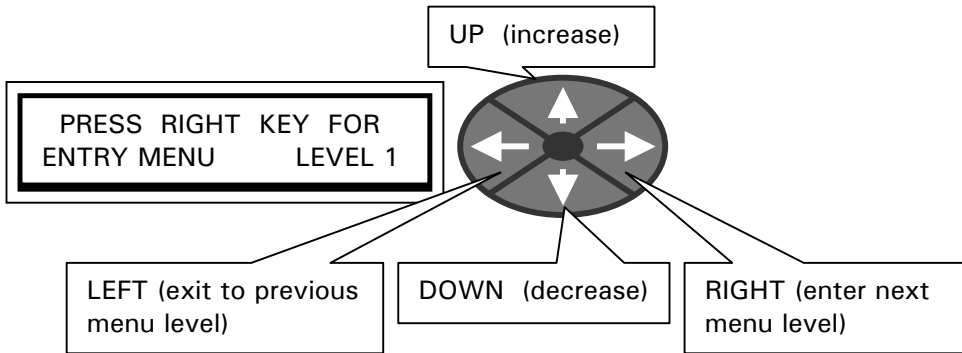

Notice that tapping the left key allows you to exit from any location back to the start point on the previous menu level. The selected menu is displayed on the upper line of characters. If you hold the left key down you will quickly arrive back at the default % diagnostic windows. The level number is displayed at the right hand end of the top line.

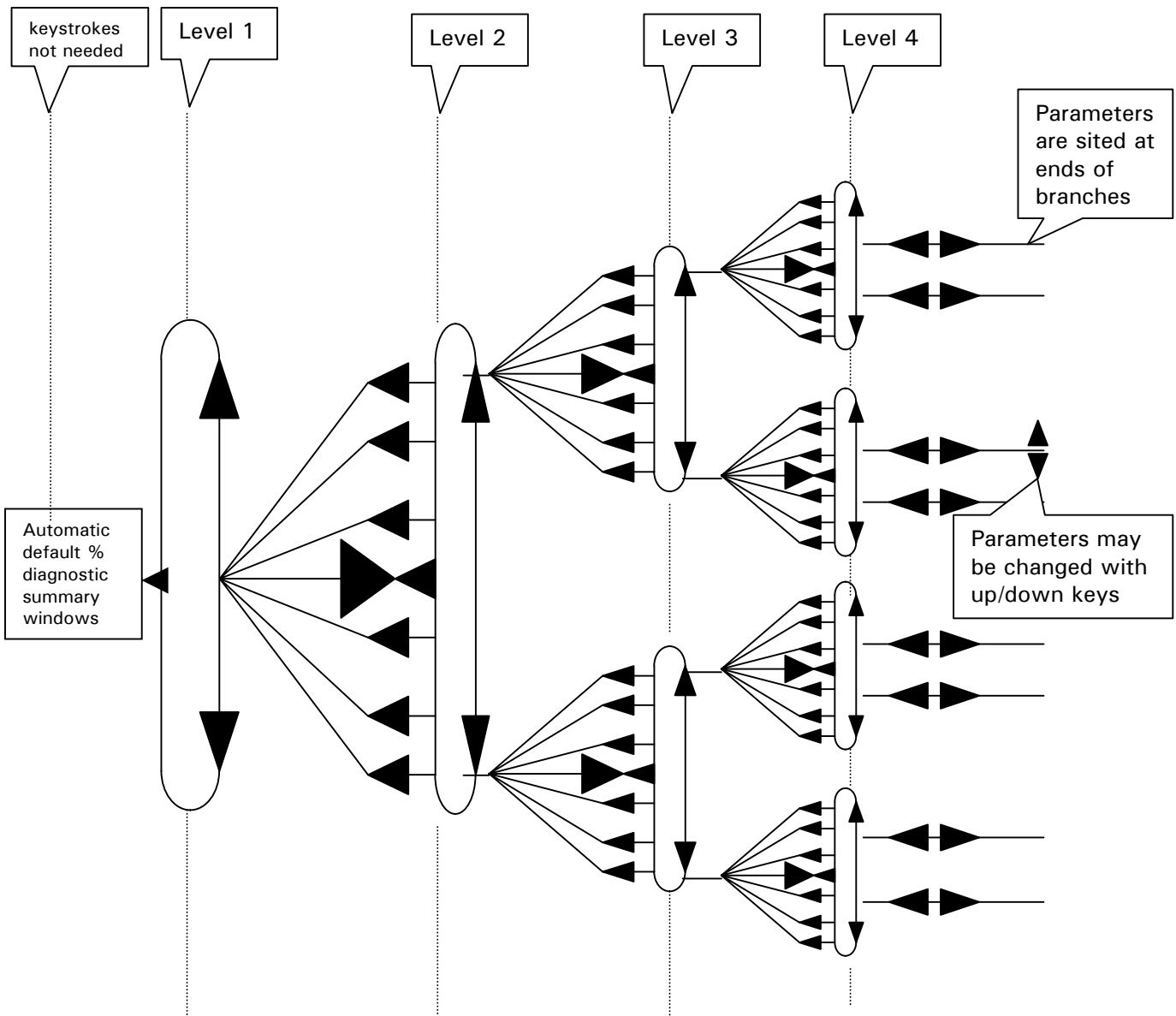

As well as travelling around the tree structure the keys perform other functions. These are as follows.

5.1.1 Incrementing and decrementing parameter values.

This is achieved using the up/down keys. All the parameters that may need changing have been placed at the end of a branch where the up/down keys change the parameter value instead of travelling. After the value has been changed it will be retained simply by backing out of that menu location using the left key.

Note. Values that are very large can be changed quickly by holding the key down which will introduce an accelerated change rate. Releasing the key returns it to a one-shot mode. When running, most windows will allow a parameter change to occur as the value is changing, as if a potentiometer was being adjusted. Some windows will request STOP DRIVE TO ADJUST if an immediate change is preferable at standstill.

5.1.2 PARAMETER SAVE

Storing the altered values in the drive so that they are retained when the control supply is removed. This is achieved by travelling to the PARAMETER SAVE location in the main menu. Press the right key to enter the PARAMETER SAVE window. Once there, using the UP key saves all the presently prevailing parameter values. The bottom line of the display will read SAVING and then FINISHED.

**If you wish to abandon changes made since the last save, simply remove the control supply WITHOUT having performed parameter save.** See 13.13.2 DRIVE PERSONALITY / Recipe page PIN 677.

Note. If the control supply dips below 80V AC without going totally off then an automatic save of the last DRIVE TRIP MESSAGE occurs. Any other parameters with the power loss memory facility are also saved. (E.g. MOTORIZED POT output). There is a hidden PIN 681 Power.SAVED ONCE MON. which is set high to indicate this has occurred. This flag is reset to zero if the internal supplies go totally off and back on again. See also 8.1.11.11 DRIVE TRIP MESSAGE / Supply phase loss.

5.1.3 Restoring the drive parameters to the default condition

Sometimes it is useful to return a unit to its default setup condition. E.g. a trial configuration may prove to be unworkable and it is easier to start again. If all 4 keys are held down during the application of the control supply, then the drive will automatically display the default parameters and connections. **(EXCEPT those in the CALIBRATION menu, and 100)FIELD VOLTS OP % for MOTOR 1 and MOTOR 2, and 680)Iarm BURDEN OHMS. These parameters remain as previously calibrated to prevent accidental de-calibration when restoring defaults).** The defaults will only be permanently retained however if they are saved using the PARAMETER SAVE menu. To revert to the last saved set, turn the control supply off, without doing a PARAMETER SAVE. **Also the PASSWORD is reset to 0000.** See 11.2 DISPLAY FUNCTIONS / PASSWORD CONTROL. See also 13.13.2 DRIVE PERSONALITY / Recipe page PIN 677, for details of 2 and 3 key reset operation and power up messages.

5.1.4 Branch hopping between monitor windows

One large class of menu is the DIAGNOSTICS. This provides a very comprehensive monitoring facility of analogue linear input signals, control logic levels, alarms and internal parameters. Each parameter to be monitored is sighted at the end of a branch. Here the up/down keys allow hopping to the adjacent branch. This removes the need to travel back to the previous level and allows rapid observation of multiple parameters. Branch hopping also occurs anywhere there are two or more adjacent monitoring windows.

5.1.5 Power up windows

A few seconds after the control supply is applied, the ENTRY MENU window is shown, after a further brief pause with no keystrokes, two default % DIAGNOSTIC summary windows are activated. See 5.1.6. The control card interrogates the power chassis during power up to find out the model type. This allows the transference of the control card to a different power chassis. See 13.13.4 DRIVE PERSONALITY / Armature current burden resistance PIN 680. See also 13.13.2 DRIVE PERSONALITY / Recipe page PIN 677. By tapping the right key you will enter the first of the menu levels of the menu tree.

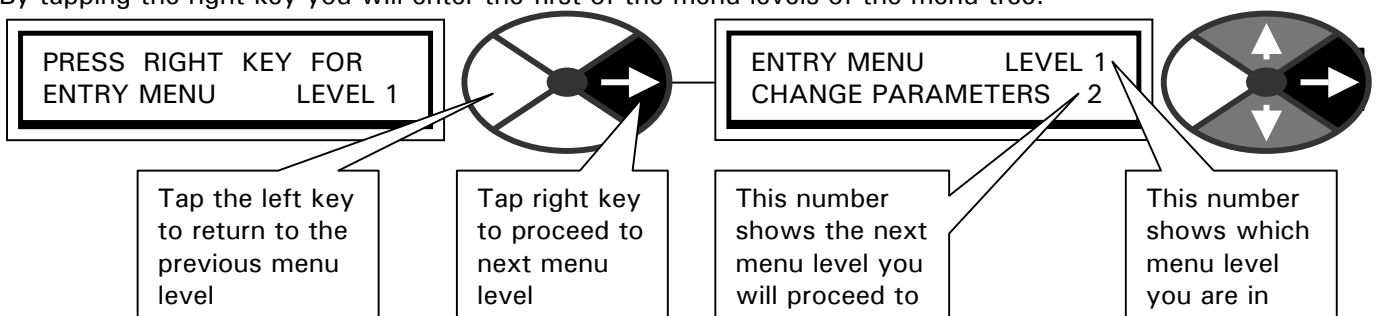

5.1.6 Default % DIAGNOSTIC summary windows

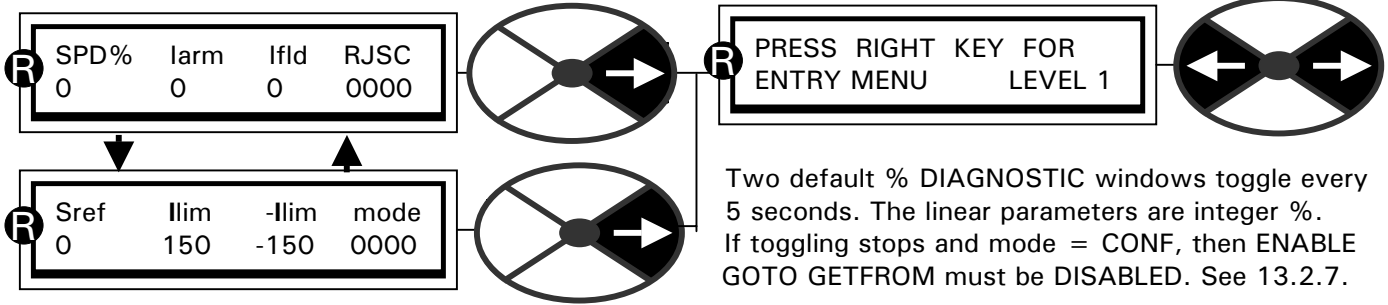

Two default % DIAGNOSTIC windows toggle every 5 seconds. The linear parameters are integer %. If toggling stops and mode = CONF, then ENABLE GOTO GETFROM must be DISABLED. See 13.2.7.

Displayed mneumonic	SPD%	Iarm	Ifld	RJSC	Sref	Ilim	-Ilim	mode
Source PIN number	131	134	144	164	123	138	139	167 (STOP/RUN)
Manual section	7.1.10	7.2.2	7.3.2	7.5.3	7.1.1	7.2.6	7.2.6	7.5.6

Note. These windows are not on the PLA unit (PLA unit contains applications blocks, I/O and comms facilities only, See website)

5.1.7 Finding the software version number of the unit.

To find the version number of the software loaded on the drive, see 11.4 DISPLAY FUNCTIONS / Software version. **This is a version 5.14 manual. Version 5.14 and above software has all the functions described.** Software version 4.05 upwards is compatible with PL PILOT version 4.05. However PL Pilot (See 13.1.1 ) will not be able to utilise or configure FIELDBUS parameters. See also 16.1 Record of modifications.

5.2 ENTRY MENU

When you enter the first vertical menu level (level 1) you will find 8 headings as you scroll up and down.

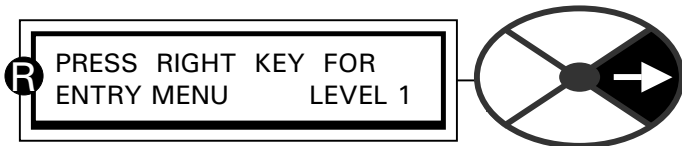

After tapping the right key to proceed to the next level, you can travel up and down the level using the up and down keys. The menus are circular so you can travel up or down to reach your desired destination. The menus are designed so that the most frequently used windows are closest to the entry points.

There are 2 styles of menu that can be selected using DISPLAY FUNCTIONS. REDUCED and FULL

The reduced menu shows only the commonly used selections and enables more rapid travel around the tree structure

If the display is shown in this manual with **R** next to it then this indicates that it is in both the reduced AND the full menu.

Note. There are about 50 adjustable parameters in the reduced menu. There is also a facility for storing a second set of reduced menu parameters which can be called into use using a digital input. See 6.1.17 CALIBRATION / Motor 1 or 2 select PIN 20 See also 11.5 Remotely mounted display unit.

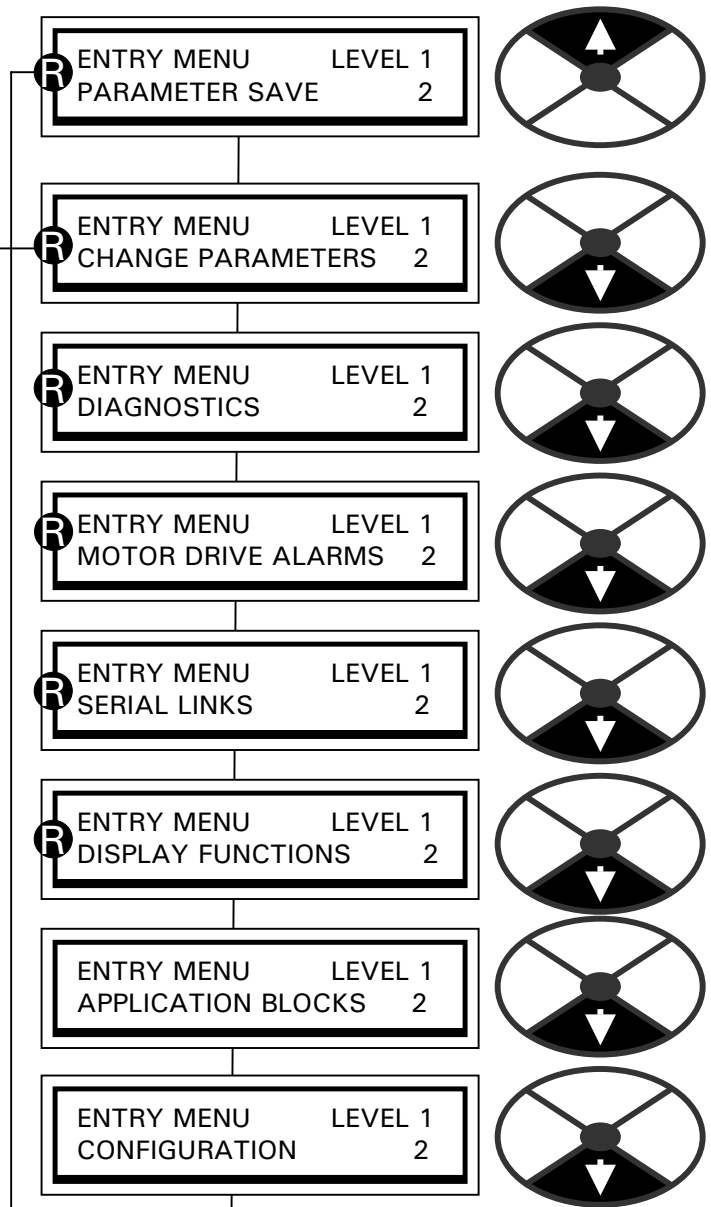



5.2.1 Full menu diagram (Change parameters)

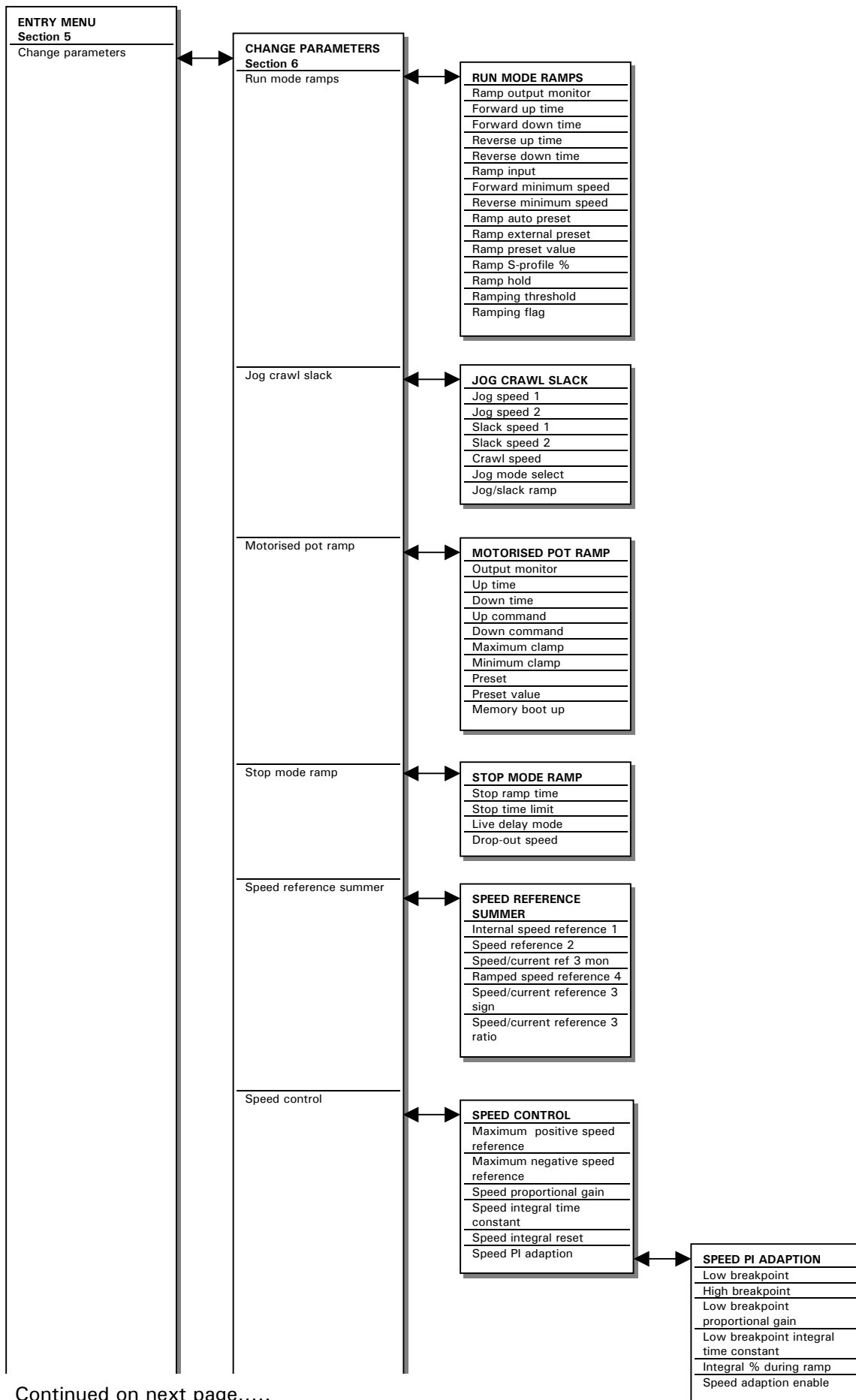

Continued on next page.....

5.2.2 Full menu diagram (Change parameters continued)

Continued from previous page.....

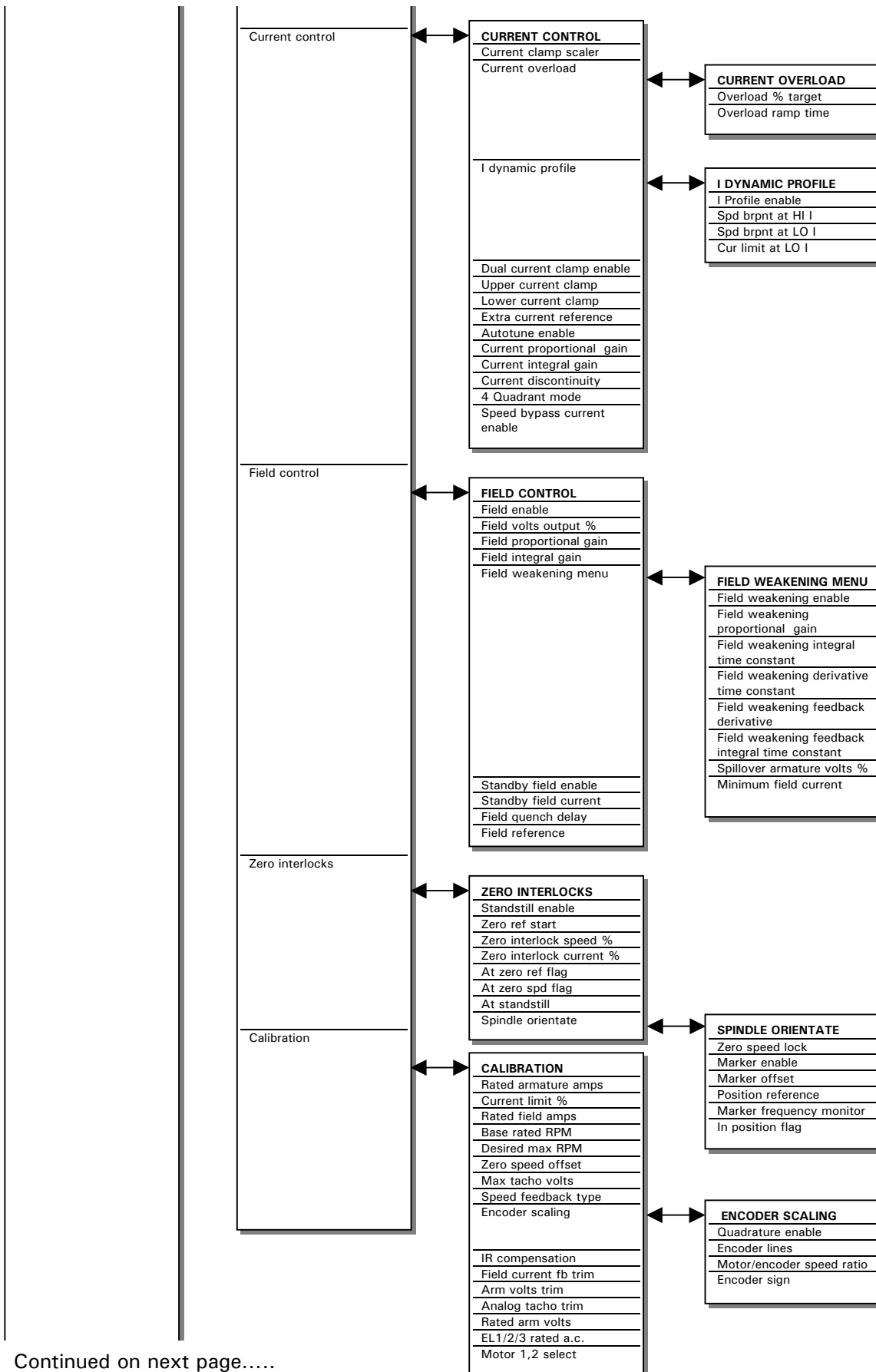

Continued on next page.....

5.2.3 Full menu diagram (Diagnostics)

Continued from previous page.....

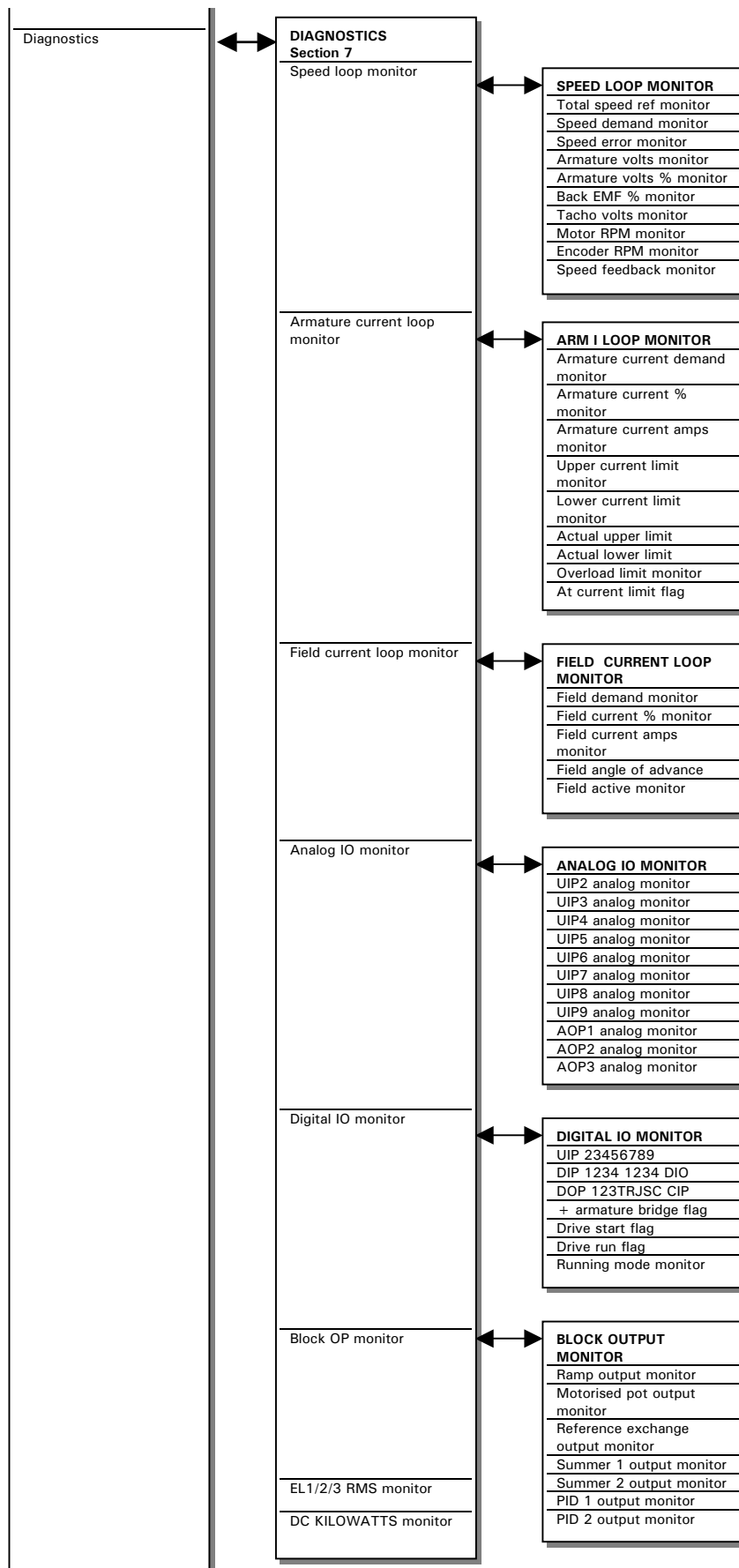

Continued on next page.....

5.2.4 Full menu diagram (Motor drive alarms, serial links and display functions)

Continued from previous page.....

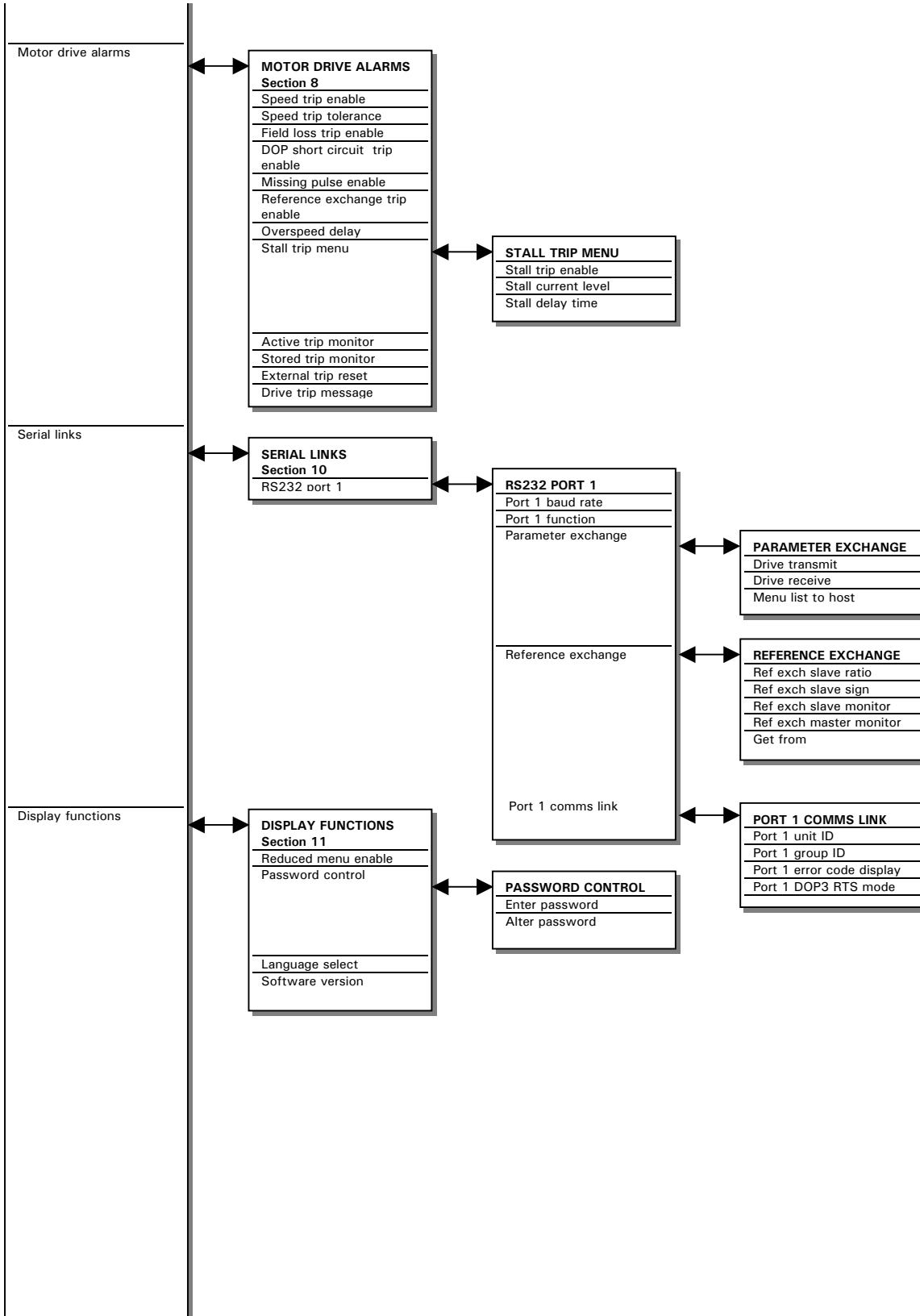

Continued on next page.....

5.2.5 Full menu diagram (Application blocks and configuration)

Continued from previous page.....

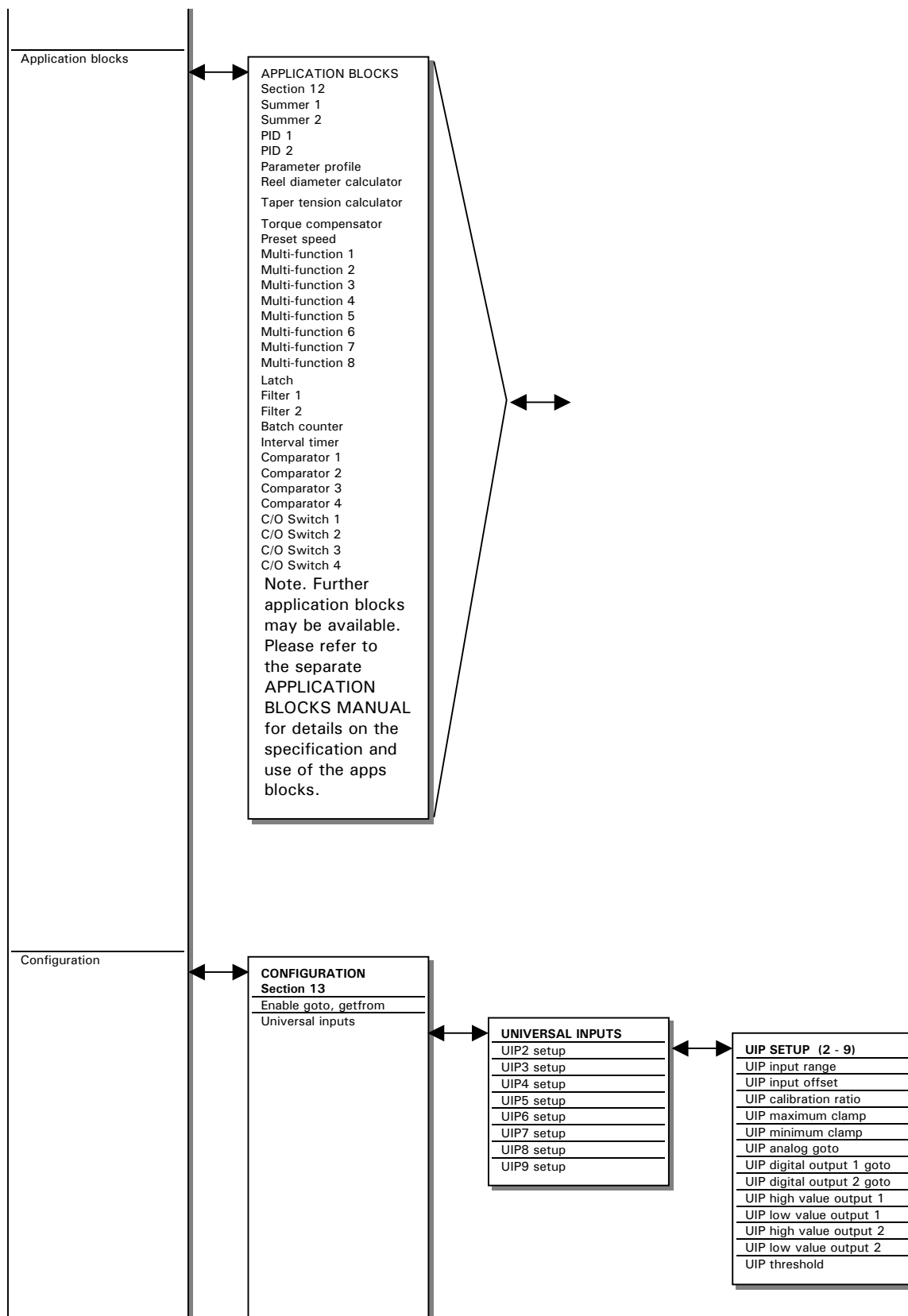

Continued on next page.....

Continued from previous page.....

5.2.6 Full menu diagram (Configuration continued)

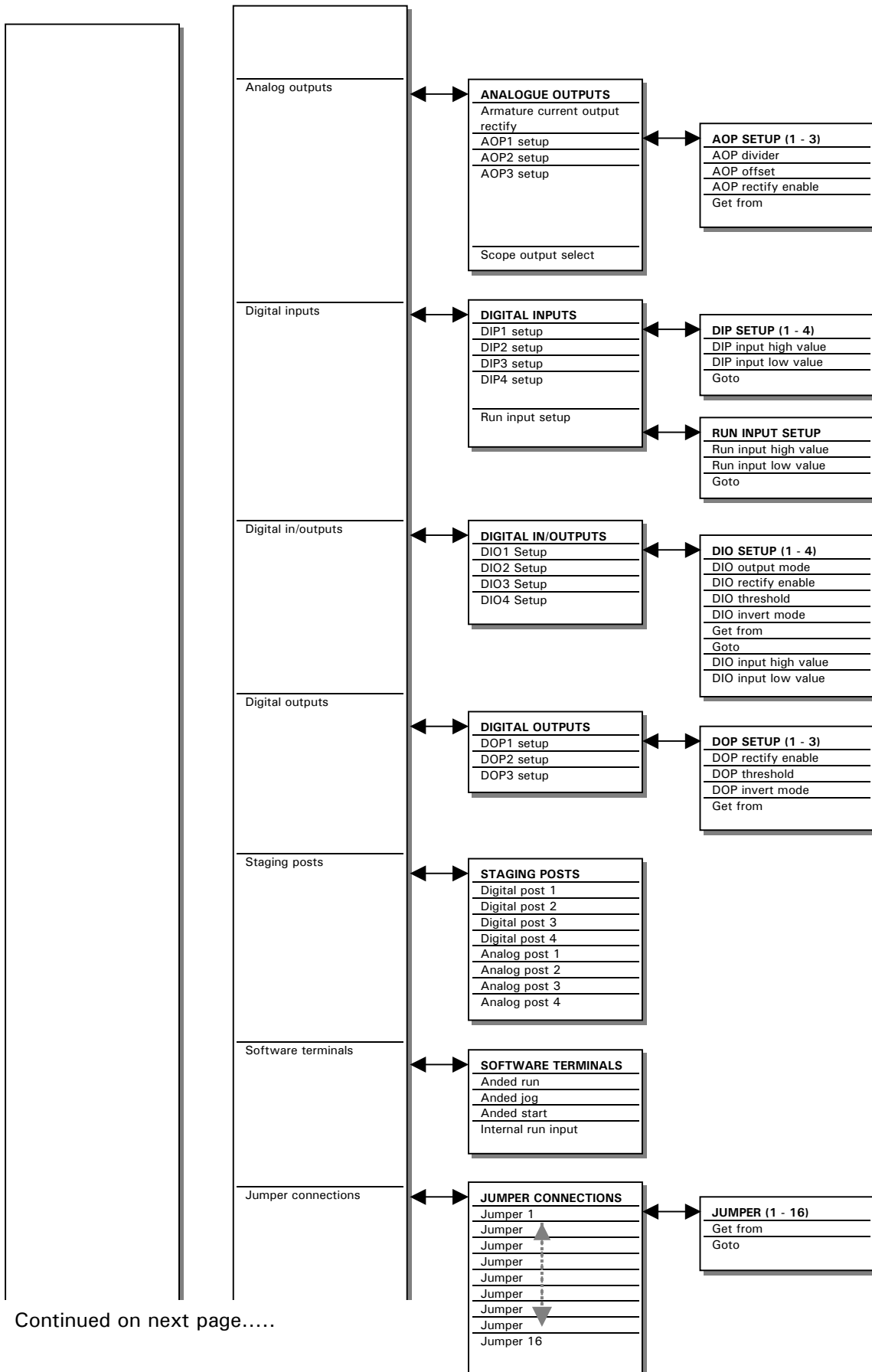

Continued on next page.....

Continued from previous page.....

5.2.7 Full menu diagram (Block OP and Fieldbus configs, Drive personality and Conflict Help)

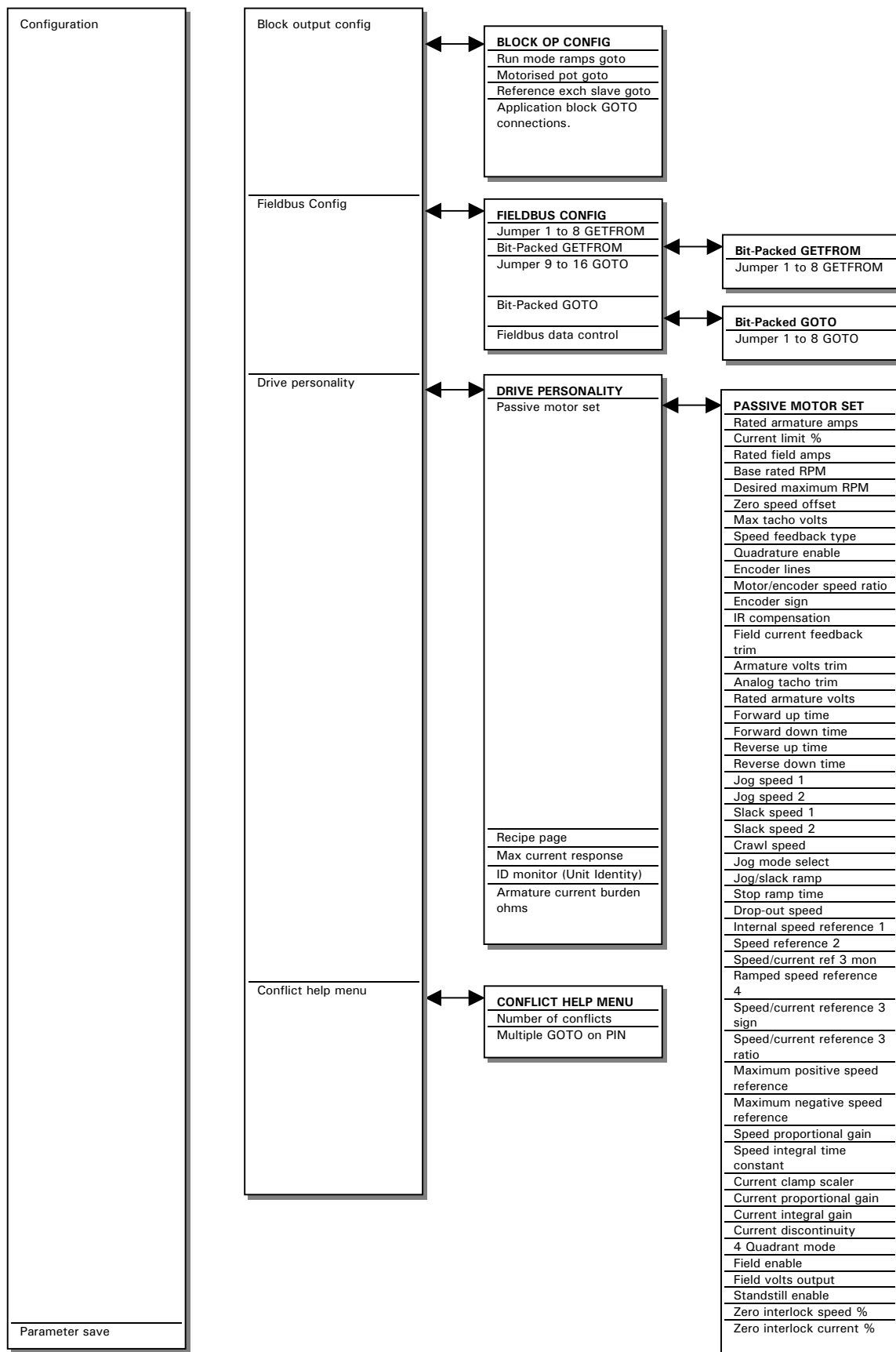

### 5.3 Archiving PL/X recipes

After a working set of parameters and configuration connections has been created, it is recommended that an archive of the recipe be made for back up purposes. **There are 2 tools available for creating an archive.**

**1) Hyperterminal in windows accessories.** See 10.2.1 PARAMETER EXCHANGE / Drive transmit. Hyperterminal loads or saves a file directly to / from the **NON volatile memory** of the PL/X in binary form. This **un-editable** file is a complete set of SAVED parameters, ideal for e-mail and archiving.

Advantages. Very compact file. Complete record of every parameter including motor and model ratings. Easy to archive and identify files.

Disadvantages. Not editable. Will overwrite 680)Iarm BURDEN OHMS, 2)RATED ARM AMPS and 4)RATED FIELD AMPS which will then need re-entering for models and/or motors of different rating to source file.

**2) PL PILOT running on windows.** See 10.2.5 Parameter exchange using ASCII COMMS And 13.1.1 PL PILOT configuration tool.

PL PILOT loads or saves a file directly to / from the **volatile memory** of the PL/X in editable form. This **editable** file is the displayed parameters and configurable connections, but does not include Armature current or Field current or special factory parameters. It is ideal for local archiving of working parameters. It is possible to archive the file on other computers (details in PILOT tool HELP button) or email the file, however the Hyperterminal tool is a better suited for file transfer between directories or via email.

Advantages. Very easy to use and allows editing of recipes. Sections of recipes may be saved. Versatile monitoring and diagnostics included. Very useful commissioning tool when used with Laptop PC.

Disadvantages. Will not overwrite 680)Iarm BURDEN OHMS, 2)RATED ARM AMPS and 4)RATED FIELD AMPS which will then need entering by hand using drive keys. Awkward to transfer files to other PC.

See also 13.13.2 DRIVE PERSONALITY / Recipe page PIN 677.

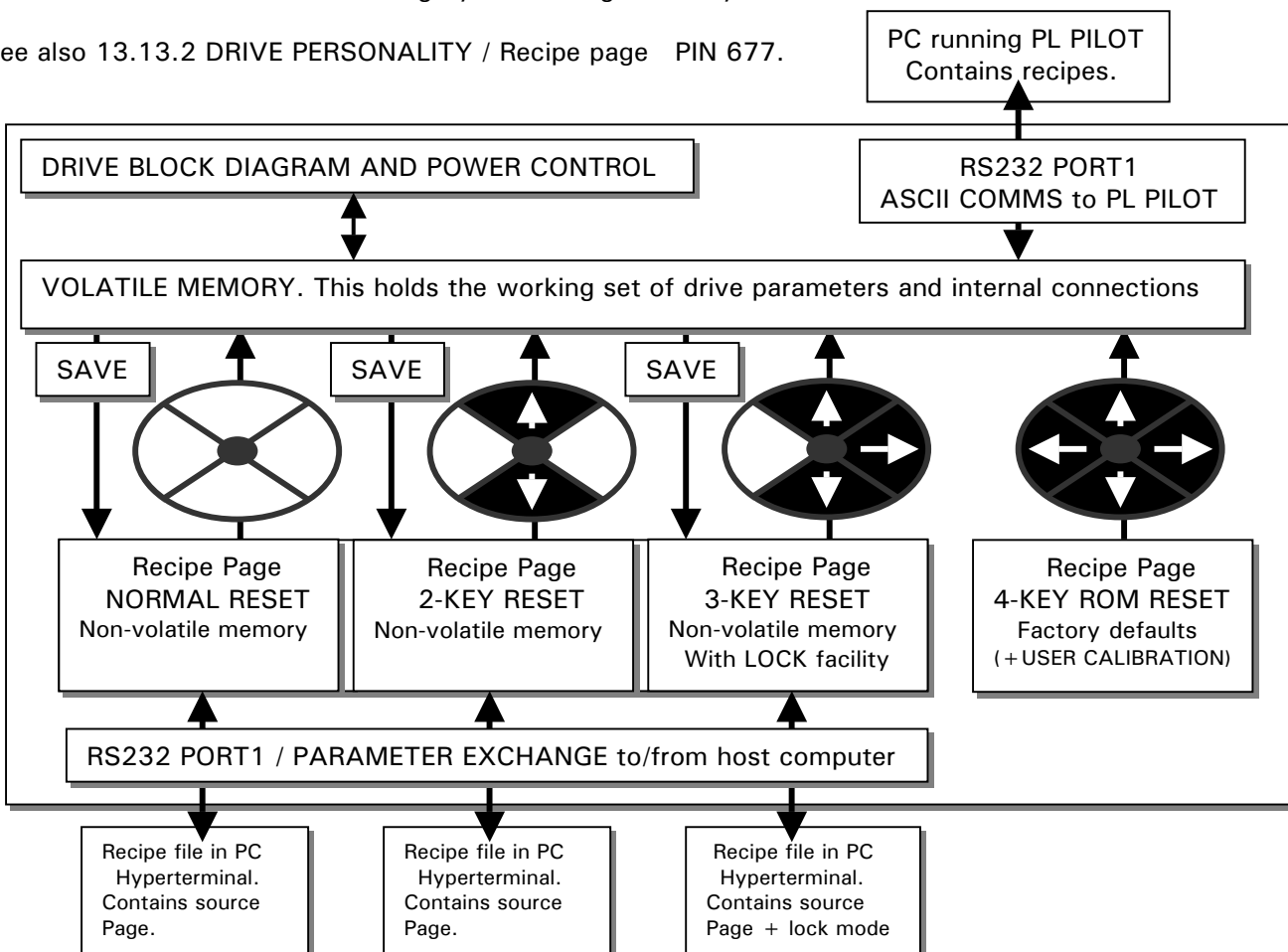



## 6 CHANGE PARAMETERS

<b>6</b>	<b>CHANGE PARAMETERS .....</b>	<b>57</b>
6.1	CHANGE PARAMETERS / CALIBRATION .....	59
6.2	CHANGE PARAMETERS / RUN MODE RAMPS.....	71
6.3	CHANGE PARAMETERS / JOG CRAWL SLACK .....	77
6.4	CHANGE PARAMETERS / MOTORISED POT RAMP .....	81
6.5	CHANGE PARAMETERS / STOP MODE RAMP .....	85
6.6	CHANGE PARAMETERS / SPEED REF SUMMER.....	90
6.7	CHANGE PARAMETERS / SPEED CONTROL.....	92
6.8	CHANGE PARAMETERS / CURRENT CONTROL .....	97
6.9	CHANGE PARAMETERS / FIELD CONTROL .....	106
6.10	CHANGE PARAMETERS / ZERO INTERLOCKS .....	113

CHANGE PARAMETERS menu



There are a very large number of parameters that can be altered by the user. All the alterable parameters have a factory default setting that in most cases will provide a perfectly workable solution and will not need altering.

One class of parameters that will need setting however is the CALIBRATION values. These are special because they are used to set the maximum ratings for the motor and drive.

The absolute maximum available armature current of any particular model will not normally exceed the CALIBRATION menu setting. If the control card is transferred to a different power chassis it will automatically interrogate the chassis to determine the frame size. The user must make sure that if the armature burden resistor value is different, then the new value is entered into the unit. See 13.13.4 DRIVE PERSONALITY / Armature current burden resistance PIN 680.

This allows owners of large numbers of drives to hold minimal spares.

Sometimes it is useful to return a unit to its default parameter condition. E.g. a trial configuration may prove to be unworkable and it is easier to start again. If all 4 keys are held down during the application of the control supply, then the drive will automatically refer to the default parameters and internal connections.

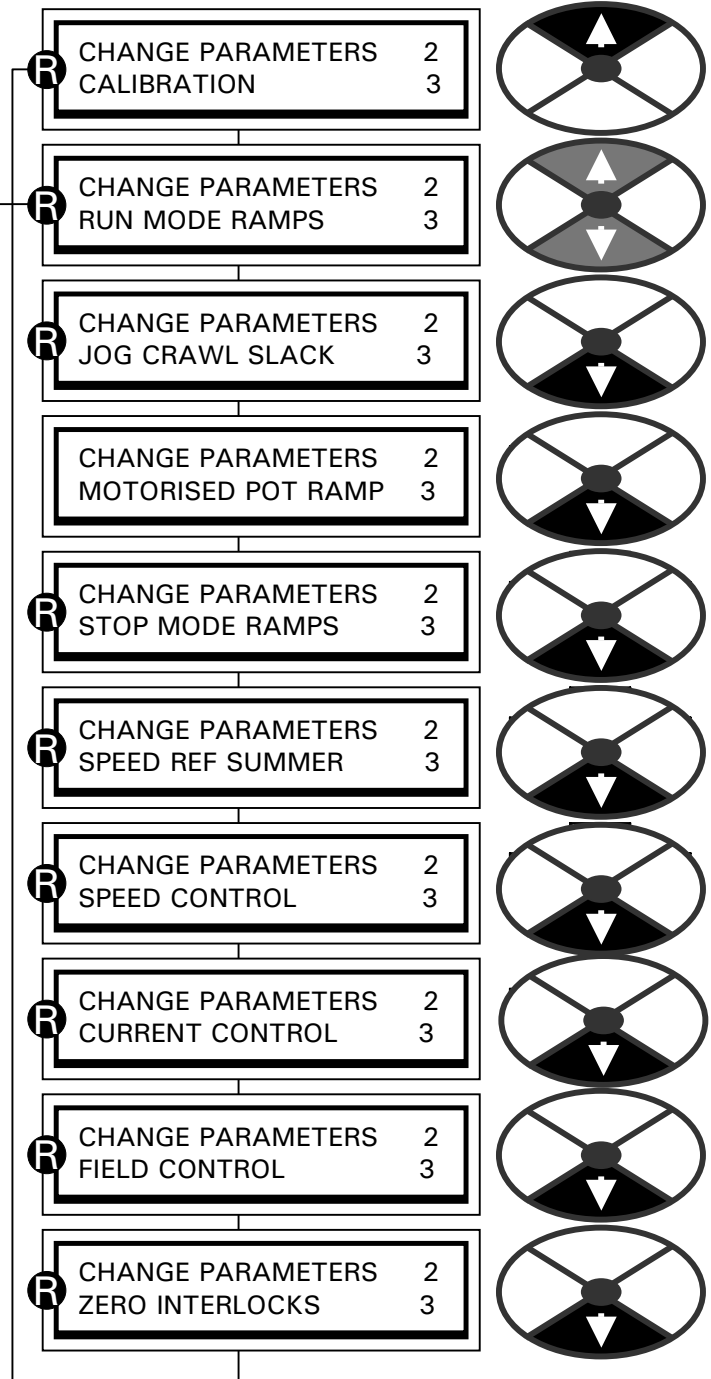

However parameters that are used to match the motor to the drive are not affected by restoring the defaults. This includes all those in the CALIBRATION menu and 100)FIELD VOLTS OP %, (for MOTOR 1 and MOTOR 2) and 680)Iarm BURDEN OHMS. These parameters remain as previously calibrated to prevent accidental de-calibration when restoring defaults. See 5.1.3 Restoring the drive parameters to the default condition

See also 13.13.2 DRIVE PERSONALITY / Recipe page PIN 677, for details of 2 and 3 key reset operation. This feature allows for 3 total instrument recipes to be stored and retrieved. WARNING. Recipe page 2 and 3 each have their own set of calibration parameters, so be careful to check them all prior to running.

### 6.1 CHANGE PARAMETERS / CALIBRATION

Calibration  
PIN numbers range 2 to 20



(Bold windows are used for QUICK START)  
Note. The parameter on the lower line is preceded by a number and bracket e.g.

**3)CURRENT LIMIT (%)**

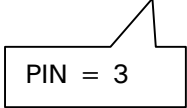

This number is important. It is called the **PIN (Parameter Identification Number)**

Each parameter has a unique PIN that is used in the process of configuration. There are up to 720 PIN numbers within the system. They are used to identify connection points when a schematic is being configured and can also hold the result of an operation or logic output.

**CONNECTIONS.** It is possible to construct complex functional blocks by making connections between parameter PINs.

When a parameter is given a value by the programming procedure, or is using its default value, it is important to understand how it is affected by a connection to another source. In this case the value is solely determined by the source, and by looking at the parameter you can use it as a diagnostic monitor of that source. The parameter value may only be re-entered if the connection from the source is first removed.

**Note. Bold windows are used for QUICK START.**

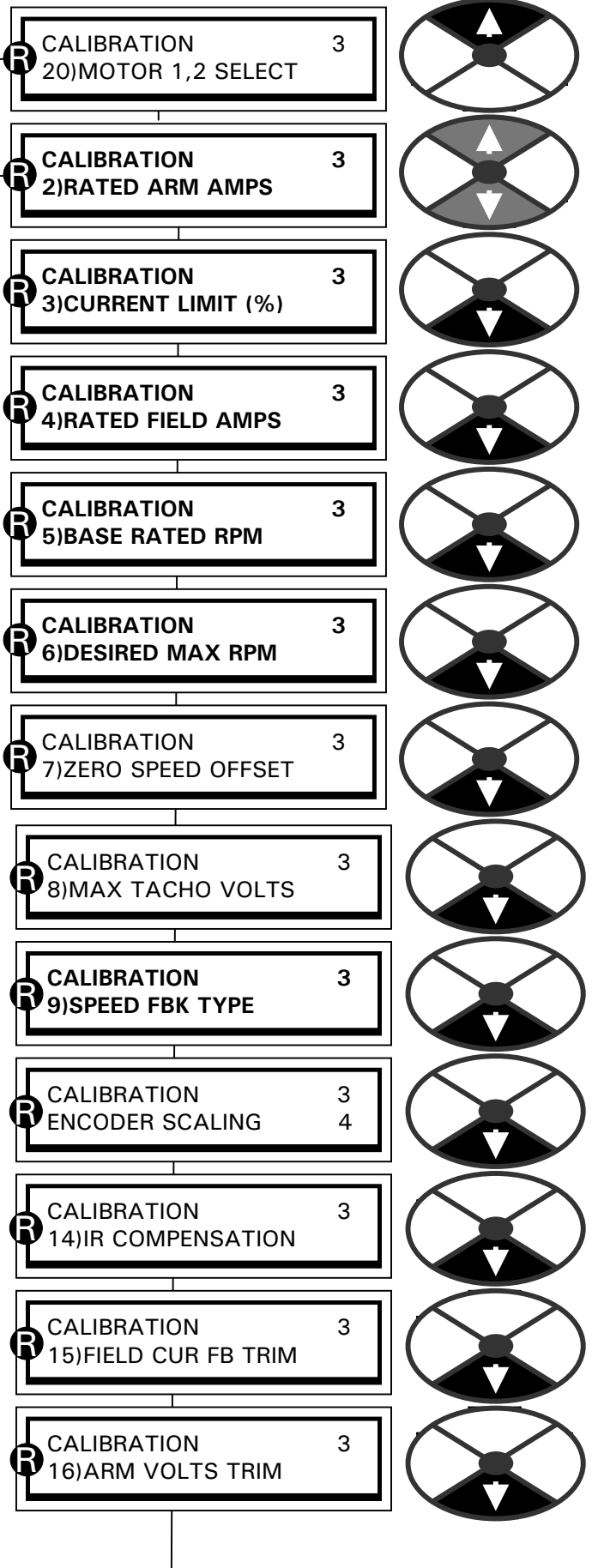
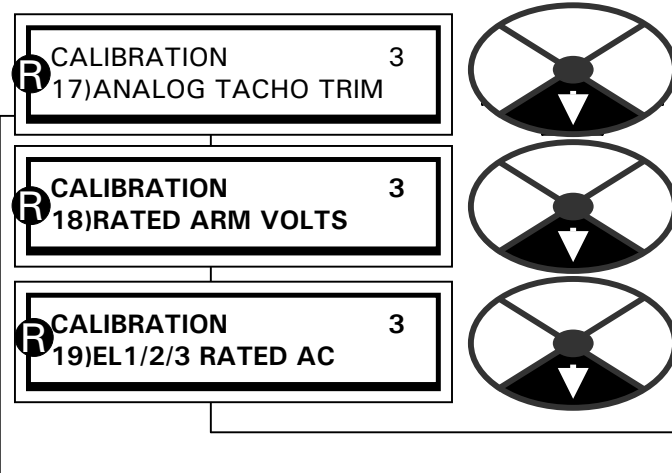

6.1.1 CALIBRATION / Block diagram

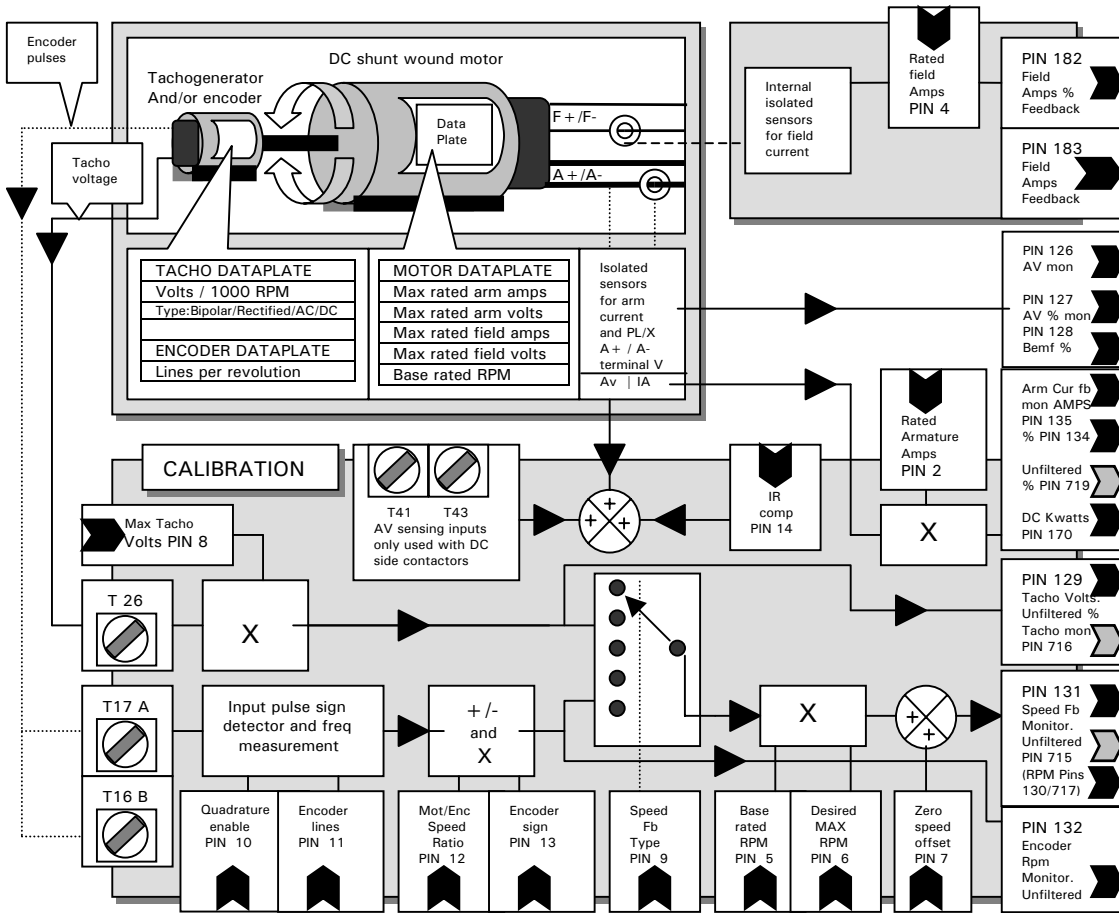

6.1.2 CALIBRATION / Rated armature amps PIN 2 QUICK START

Note the presence of a PIN number on the bottom line shows that one more step right takes us to the end of a branch.

Then we reach the end of a branch of the tree and this has resulted in a parameter value on the lower line which can be modified by use of the up/down keys.

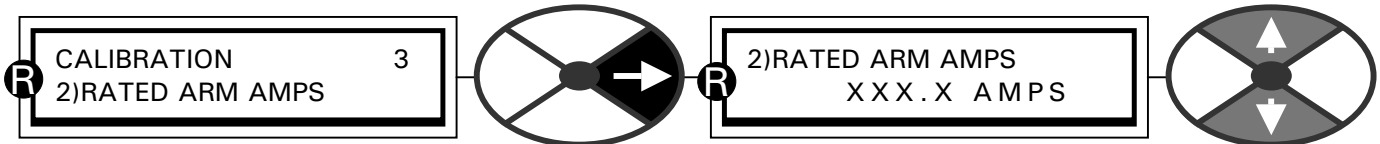

PARAMETER	RANGE	DEFAULT	PIN
RATED ARM AMPS	33 -100% of PL/X rating	(33%)XXX.X A	2

This current may be less than the value on the motor data-plate, but must not normally be higher. (However, see also 6.8.3.1.2 How to get overloads greater than 150% using 82)O/LOAD % TARGET).

See 13.13.4 DRIVE PERSONALITY / Armature current burden resistance PIN 680

6.1.3 CALIBRATION / Current limit (%) PIN 3 QUICK START

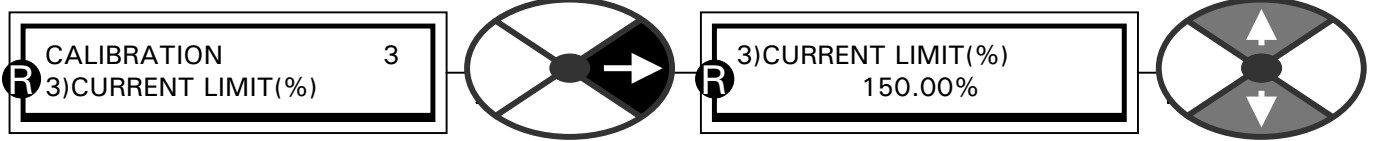

This is the desired current limit % of 2)RATED ARM AMPS	PARAMETER	RANGE	DEFAULT	PIN
	CURRENT LIMIT(%)	0 to150% of rated motor amps	150.00%	3

This parameter may be adjusted whilst the PL/X is running.

If a 150% overload limit is too low for your application then it is possible to cater for larger overload percentages on motors smaller than the PL/X model armature current rating.

See 6.8.3.1 CURRENT OVERLOAD / Overload % target PIN 82.

If the current exceeds the level set by the overload target, then after an appropriate dwell time, it is progressively reduced to the overload target level.

Table showing maximum overloads according to:- Full load motor current, as a % of 2)RATED ARM AMPS.

Full load motor current (82)O/LOAD % TARGET) as a % of 2)RATED ARM AMPS	Maximum available	Maximum overload % available. (With respect to full load motor current)
100%	150%	150 / 100 = 150%
90%	150%	150 / 90 = 166%
80%	150%	150 / 80 = 187%
75%	150%	150 / 75 = 200%
60%	150%	150 / 60 = 250%
50%	150%	150 / 50 = 300%
37.5%	150%	150 / 37.5 = 400%
30%	150%	150 / 30 = 500%

If 3)CURRENT LIMIT(%) or if 82)O/LOAD % TARGET level is set to 0% then no permanent current will flow. See 6.8.3.1 CURRENT OVERLOAD / Overload % target PIN 82.

6.1.4 CALIBRATION / Rated field amps PIN 4 QUICK START

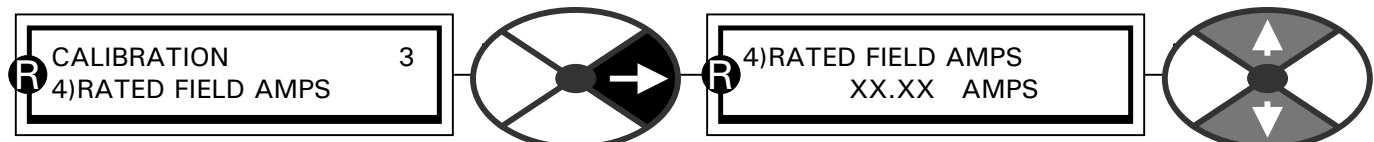

This is the desired 100% DC output field current in amps	PARAMETER	RANGE	DEFAULT	PIN
	RATED FIELD AMPS	0.1A -100% of model rating	25% AMPS	4

If the field amps is not given on the motor dataplate, you can deduce it by measuring the resistance of the field winding after allowing it to reach full working temperature, then using the following equation

$$\text{Field current} = \text{Field dataplate volts} / \text{Resistance in Ohms}$$

Alternatively if you know the rated field voltage, you can go to the CHANGE PARAMETERS / FIELD CONTROL menu, and select the 100)FIELD VOLTS OP % clamp parameter. Adjust the field output voltage to the dataplate value, as a % of the applied AC supply. Please ensure that 4)RATED FIELD AMPS is sufficiently high to force the 100)FIELD VOLTS OP % clamp into operation at the desired voltage under all conditions.

4)RATED FIELD AMPS scaled by 114)FIELD REFERENCE sets the demand for the field current control loop. and 100)FIELD VOLTS OP % operates as a clamp on the field bridge firing angle.

The one that results in the lower output, has priority.

Hence it is possible to operate with the field current control prevailing and the voltage % as a higher safety clamp, or the voltage % clamp prevailing and the field current control as a higher safety level.

## 6.1.5 CALIBRATION / Base rated motor rpm PIN 5 QUICK START

**R** CALIBRATION 3  
5)BASE RATED RPM

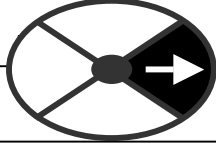

**R** 5)BASE RATED RPM  
1500 RPM

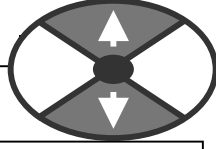

PARAMETER	RANGE	DEFAULT	PIN
BASE RATED RPM	0 – 6000 RPM	1500	5

Revs per minute of the motor at full field and armature volts.

This value is usually found on the motor dataplate.

## 6.1.6 CALIBRATION / Desired max rpm PIN 6 QUICK START

**R** CALIBRATION 3  
6)DESIRED MAX RPM

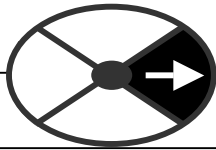

**R** 6)DESIRED MAX RPM  
1500 RPM

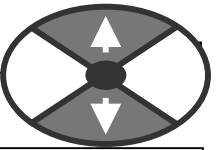

PARAMETER	RANGE	DEFAULT	PIN
DESIRED MAX RPM	0 – 6000 RPM	1500	6

Revs per minute of the motor at your desired maximum speed

This represents 100% speed.

If your DESIRED MAXIMUM RPM is higher than the BASE RATED RPM then you will need to implement field weakening in the CHANGE PARAMETERS / FIELD CONTROL menu. You must however verify that your motor and load are rated for rotation above base speed. **Failure to do so may result in mechanical failure with disastrous consequences.**

If however your desired maximum rpm is low compared to the base rpm then you need to be aware of the heat dissipation in the motor at full torque. Use force venting of the motor if necessary.

## 6.1.7 CALIBRATION / Zero speed offset PIN 7

**R** CALIBRATION 3  
7)ZERO SPEED OFFSET

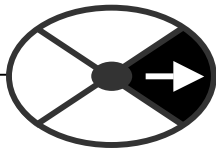

**R** 7)ZERO SPEED OFFSET  
0.00%

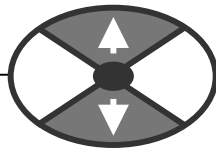

PARAMETER	RANGE	DEFAULT	PIN
ZERO SPEED OFFSET	+/-5.00%	0.00%	7

Used to correct any offset from the speed feedback source.

This is useful if your speed feedback is derived from an external amplifier which may have a small offset.

6.1.8 CALIBRATION / Max tacho volts PIN 8

**R** CALIBRATION 3  
8)MAX TACHO VOLTS

**R** 8)MAX TACHO VOLTS  
60.00V

Scales the tacho input for full feedback volts at 100% speed

PARAMETER	RANGE	DEFAULT	PIN
MAX TACHO VOLTS	+/-200.00 volts	60.00V	8

Multiply the output volts per rev value for the tacho by the full speed rpm of the tacho  
 e. g. 1 tacho rating = 0.06 V per rev, 100% speed of tacho = 500 rpm, then tacho scaling = 30.00V  
 e. g. 2 tacho rating = 0.09 V per rev, 100% speed of tacho = 2000 rpm, then tacho scaling = 180.00V

Alternatively, for systems NOT employing field weakening, run the system in AVF at desired full speed and monitor the tacho volts. See 7.1.7 SPEED LOOP MONITOR / Tachogenerator volts monitor PIN 129, then after entering the observed full speed tacho volts, convert to tacho feedback. See 3.4.4 Analogue tachogenerator input, also 6.1.9 CALIBRATION / Speed feedback type PIN 9 QUICK START.

The sign of the parameter should correspond to the sign of the tacho volts for positive speed demand.

For tacho volts which exceed 200V full scale, it is necessary to provide an external resistor dropper network as follows.

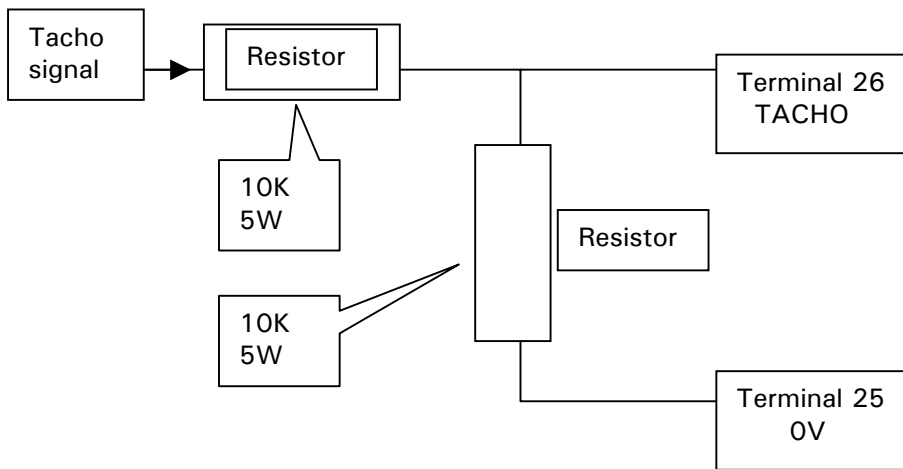

The network shown will allow full scale voltages up to 400 Volts. The number scrolled in the window should be set to half the full scale tacho volts. Appropriate measures must be taken to dissipate the heat from the dropper resistors. The total power in watts dissipated will be  $(\text{Tacho signal volts})^2 / 20,000$ .

There is a tacho failure detection system that may be configured to either trip the drive, or automatically switch to AVF. See 8.1.1 MOTOR DRIVE ALARMS / Speed feedback mismatch trip enable PIN 171.

See also 3.4.4 Analogue tachogenerator input.

## 6.1.9 CALIBRATION / Speed feedback type PIN 9 QUICK START

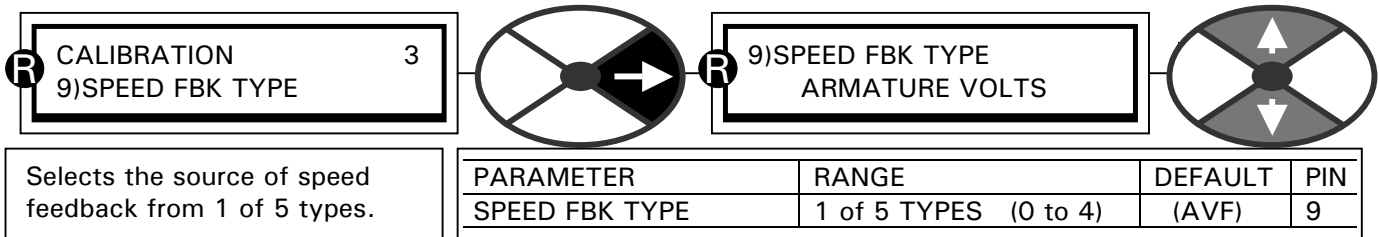

Selects the source of speed feedback from 1 of 5 types.

The speed feedback can be derived from 1 of 3 fundamental sources or a combination of them.

**All 3 sources may be independently monitored.** See 7.1 DIAGNOSTICS / SPEED LOOP MONITOR.

**0) ARMATURE VOLTS (AVF).** Internal isolated signal always available. The 100% speed feedback volts must be calculated and entered into PIN 18 RATED ARM VOLTS. Note. 130)MOTOR RPM MON will only be accurate when 18)RATED ARM VOLTS corresponds to 6)DESIRED MAX RPM, for 100% speed.

**WARNING. Do not use this feedback mode with field weakening systems.**

See 6.9.6 FIELD CONTROL / FLD WEAKENING MENU for a note about AVF / field weakening trip.

AVF feedback contains more ripple than tacho feedback. It may be necessary for smooth operation to reduce the SPEED CONTROL loop gain with AVF. See 6.7.4 SPEED CONTROL / Speed proportional gain PIN 71.

The accuracy of AVF is about 2% of full speed, it can be improved in 2 ways.

a) By applying IR compensation to the feedback. This IR drop is an element within the AVF that is created by the armature current flowing through the armature resistance. This element is not part of the back EMF of the motor and therefore if it is removed from the AVF signal, the feedback is more accurate.

See 6.1.11 CALIBRATION / IR compensation PIN 14.

b) By running the field control in CURRENT mode. This forces the field current (and hence flux) to remain constant which in turn makes the relationship between speed and AVF more accurate.

See also 8.1.1 MOTOR DRIVE ALARMS / Speed feedback mismatch trip enable PIN 171.

When the drive is first being commissioned it is recommended that the AVF mode be used initially. This allows any other speed feedback transducers to be examined for correct outputs prior to relying on them for control safety. **For systems employing a DC contactor you must use T41 and T43 for remote AVF.**

**1) ANALOG TACHO.** This transducer provides a DC voltage proportional to speed.

The 100% speed feedback volts must be calculated and entered into 8)MAX TACHO VOLTS.

Note. 130)MOTOR RPM MON will only be accurate when 8)MAX TACHO VOLTS corresponds to 6)DESIRED MAX RPM, for 100% speed. See also 3.4.4 Analogue tachogenerator input.

Note. With an additional bi-directional shaft mounted encoder it is possible to lock and/or orientate the shaft at zero speed. See 6.10.9 ZERO INTERLOCKS / SPINDLE ORIENTATE.

There is a tacho failure detection system that may be configured to either trip the drive, or automatically switch to AVF. See 8.1.1 MOTOR DRIVE ALARMS / Speed feedback mismatch trip enable PIN 171.

**2) ENCODER.** This shaft-mounted transducer provides a stream of pulses with a frequency proportional to speed. The pulses can be a single stream with a separate direction logic output. (Low for reverse, high for forward), or a dual stream of pulses in phase quadrature. The quadrature information is decoded by the PL/X to determine the rotation direction. Either type may be selected for use in the ENCODER sub menu.

Note. Low frequencies give poor performance. The lower limit for reasonable performance is a 100% input frequency (ie. **at full speed of encoder**) of 15Khz (450 lines at 2000 rpm single pulse train or 225 lines at 2000 rpm for quadrature type). With more lines performance improves, with less, dynamic stability degrades. The 100% speed feedback RPM is determined from 6)DESIRED MAX RPM. For lower full scale frequencies see type 3 or 4 feedback modes below.

Note. With bi-directional encoder feedback it is possible to lock and/or orientate the shaft at zero speed. See 6.10.9 ZERO INTERLOCKS / SPINDLE ORIENTATE.

Note. DIP3 (T16) and DIP4 (T17) are designed to accept bi-directional encoder pulse trains. The encoder outputs must be able to provide a logic low below 2V, a logic high above 4V, may range up to 50V max and up to 100KHz. These 2 inputs are single ended and non-isolated. For other types of encoder electrical output,



the user must provide some external conditioning circuitry. The output format may be pulse only for single direction, pulse with sign, or phase quadrature. See 6.1.10 CALIBRATION / ENCODER SCALING.

There is an encoder failure detection system that may be configured to either trip the drive, or automatically switch to AVF. See 8.1.1 MOTOR DRIVE ALARMS / Speed feedback mismatch trip enable PIN 171.

**3) ENCODER + ARM VOLTS.** In this mode the AVF provides the main dynamic feedback, and the encoder feedback is used to trim the accuracy to an extremely high level.

Note. Low frequencies give poor performance. The lower frequency limit of reasonable performance with encoder + AV feedback is a 100% input frequency of 2Khz ( e. g. 60 lines at 2000 rpm single pulse train or 30 lines at 2000 rpm for a quadrature encoder). With more lines the performance improves, with less the dynamic stability degrades, particularly at low speeds.

In this mode, when using a non quadrature single line encoder, the feedback sign is automatically provided by the AVF and T16 digital input is made free for other uses. (Unless zero speed lock is required. See 6.10.9 ZERO INTERLOCKS / SPINDLE ORIENTATE. In this case T16 is still required for the encoder direction).

The final steady state 100% speed feedback RPM is determined from 6)DESIRED MAX RPM. The dynamic scaling is derived from 18)RATED ARM VOLTS. These 2 full scale settings must correspond with each other for optimum performance.

AVF feedback usually contains ripple, hence it is advisable to reduce the SPEED CONTROL loop gains with AVF feedback selected. See 6.7.4 SPEED CONTROL / Speed proportional gain PIN 71.

There is an encoder failure detection system that may be configured to either trip the drive, or automatically switch to AVF. See 8.1.1 MOTOR DRIVE ALARMS / Speed feedback mismatch trip enable PIN 171.

**4) ENCODER + TACHO.** In this mode the tachogenerator provides the main dynamic feedback, and the encoder trims the accuracy to an extremely high level.

Note. Low frequencies give poor performance. The limit of reasonable performance with encoder + tacho feedback is provided with a full speed input frequency of 2Khz (60 lines at 2000 rpm single pulse train or 30 lines at 2000 rpm for quadrature encoder). With more lines the performance improves, with less the dynamic stability degrades, particularly at low speeds.

In this mode, when using a non quadrature single line encoder, the feedback sign is automatically provided by the tacho and T16 digital input is made free for other uses. (Unless zero speed lock is required. See 6.10.9 ZERO INTERLOCKS / SPINDLE ORIENTATE In this case T16 is still required for direction.)

An encoder and/or tacho failure detection system may be configured to either trip the drive, or automatically switch to AVF. See 8.1.1 MOTOR DRIVE ALARMS / Speed feedback mismatch trip enable PIN 171.

The final steady state 100% speed feedback RPM is determined from 6)DESIRED MAX RPM. The dynamic scaling is derived from 8)MAX TACHO VOLTS. These 2 full scale settings must correspond.

6.1.10 CALIBRATION / ENCODER SCALING

The ENCODER SCALING screen is the entry point to a further sub-menu which performs the process

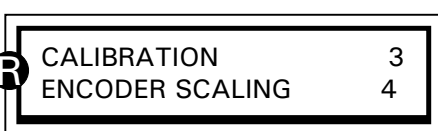

of setting the encoder parameters.

Note. See 7.1.9 SPEED LOOP MONITOR / Encoder RPM monitor PIN 132 which shows the encoder RPM irrespective of whether the encoder is being used for feedback or not.

Note. With no encoder fitted you may ignore this sub-menu.

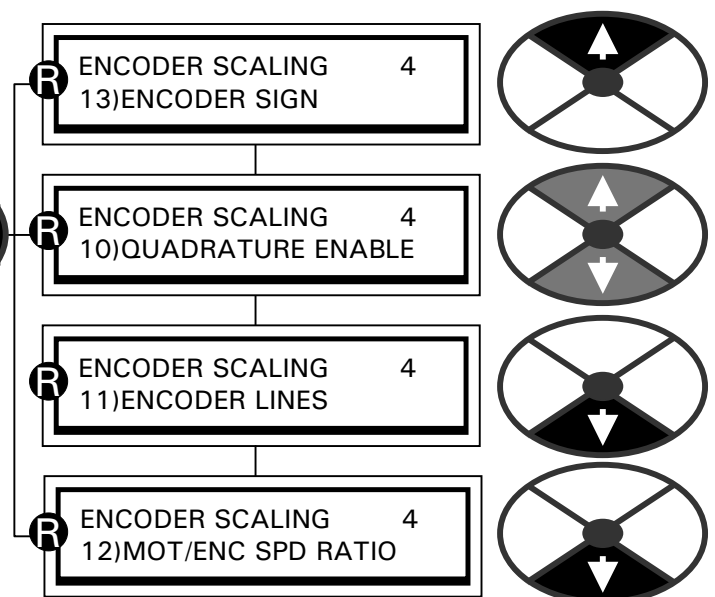

## 6.1.10.1 ENCODER SCALING / Quadrature enable PIN 10

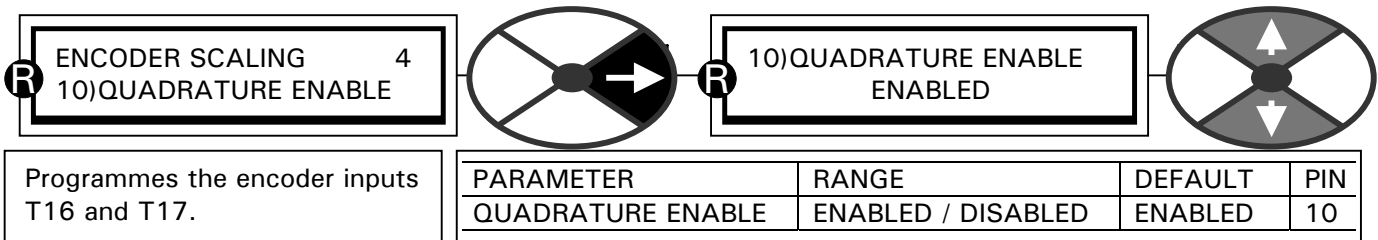

Programmes the encoder inputs T16 and T17.

The encoder inputs on T16 and T17 can be programmed to accept 2 types of encoder pulse trains.

**0) Pulse with sign. QUADRATURE (DISABLED).** A single train of pulses on T17 with a rotation direction logic signal on T16 (low for reverse, high for forward). The logic level may be inverted using the 13)ENCODER SIGN parameter. Note. When this type of encoder is used in conjunction with AVF or tachometer, the feedback sign is automatically provided by the analog feedback and T16 digital input is made free for other uses. (Unless zero speed lock is required. See 6.10.9 ZERO INTERLOCKS / SPINDLE ORIENTATE. In this case T16 is still required for the encoder direction.). See 6.1.9 CALIBRATION / Speed feedback type PIN 9 QUICK START.

**1) 2 pulse trains in phase quadrature. QUADRATURE (ENABLED).** The encoder provides 2 pulse trains phase shifted by 90 degrees. They are nominated the A train (on T17) and the B train (on T16). The A train should lead the B train for forward rotation, (positive demand) and B leads A for reverse. The drive automatically decodes the quadrature information to produce a rotation direction sign. This may be inverted using the 13)ENCODER SIGN parameter.

**Note.** When using encoders with quadrature outputs it is very important that the phase difference between the 2 pulse trains remains as close to 90 degrees as possible. If the encoder is not mounted and centered accurately on the shaft, it can cause skewing of the internal optics as the shaft rotates. This produces a severe degradation of the phase relationship on a cyclical basis. If the encoder appears to gyrate as the shaft rotates you must rectify the problem before trying to proceed with commissioning. The best way of checking the output is to use a high quality oscilloscope and observe both pulse trains for good phase holding and no interference. Do this with the drive rotating to +/- 100% speed using AVF as the feedback source.

Low frequency feedback may give poor results at low speed. Hence for encoders or other types of pick up providing less than 15KHz at full speed it is recommended that mode 3 or mode 4 combined feedback type is utilised. See 6.1.9 CALIBRATION / Speed feedback type PIN 9 QUICK START.

The encoder inputs have to be able to deal with and recognise very short pulses. This means that it is not possible to provide heavy noise filtering on these inputs. Therefore it is very important that the signals input on terminals 16 and 17 are clean and noise free.

One of the prime causes of unwanted noise on encoder signals is ground loops. If the encoder electronics is earthed at the motor end then this may cause problems.

Make sure the encoder electronics 0V is separately wired back to DOV on terminal 13, with no other earth connections at the motor end.

The encoder casing will probably be earthed by virtue of its mechanical connection to the motor or machine. This is usually acceptable as long as the internal electronics 0V has a separate connection. Some encoder manufacturers provide a by-pass capacitor inside the encoder between the electronics 0V and the casing. Unfortunately the capacitor makes a very effective high frequency ground loop and may have to be removed to prevent ground loop noise on the encoder signals. (Consult encoder supplier).

Ultimately it may be necessary to install an isolation link in the encoder loop.

Make sure the encoder cables are routed away from heavy current or other noise generating cables. Use insulated screened cable with a separate screen for each encoder signal connected at the drive terminal T13. The encoder 0V and +24V should also be screened within the cable.

6.1.10.2 ENCODER SCALING / Encoder lines PIN 11

R

ENCODER SCALING      4  
 11) ENCODER LINES

R

11)ENCODER LINES  
 1000

Inputs the encoder resolution in pulses per rev .

PARAMETER	RANGE	DEFAULT	PIN
ENCODER LINES	1 to 6000	1000	11

The number of lines on the encoder dataplate should be entered. Alternatively enter the number of cycles of high/low for one pulse train during one revolution. E. G. for a toothed gear wheel with 60 teeth and a magnetic pick up, enter the number 60. Note that there is an upper frequency limit of 100 kHz.

6.1.10.3 ENCODER SCALING / Motor / encoder speed ratio PIN 12

R

ENCODER SCALING      4  
 12)MOT/ENC SPD RATIO

R

12)MOT/ENC SPD RATIO  
 1.0000

Sets the motor revs as a ratio of the encoder revs.

PARAMETER	RANGE	DEFAULT	PIN
MOT/ENC SPD RATIO	0.0000 to 3.0000	1.0000	12

Note. The encoder is sometimes not fixed to the motor shaft, and may rotate at an RPM that is a non unity ratio of the motor RPM. Some systems have the encoder geared up to obtain a higher feedback frequency.

$$\text{MOT/ENC SPD RATIO} = \text{Motor RPM} / \text{Encoder RPM} \quad (\text{true for all speeds})$$

When using encoders it is advisable to initially run the system in AVF mode to verify the integrity of the encoder feedback signals using an oscilloscope. Then after setting the QUADRATURE ENABLE and ENCODER LINES parameters, run the system in AVF feedback mode, and monitor 132)ENCODER RPM in the DIAGNOSTICS menu. This will verify the encoder operates as expected prior to using it as a feedback source.

Note. An encoder may be input and used for other tasks instead of feedback. On hidden PIN 709)MOTOR RPM %, is the encoder feedback %, scaled to 100% = 6)DESIRED MAX RPM. It is also scaled by 12)MOT/ENC SPD RATIO which acts as a pure multiplying factor.

**Both 132)ENCODER RPM and PIN 709)MOTOR RPM %, are purely encoder signals, that work independently of the type of feedback selected. They both read zero with no pulses on the encoder inputs.**

6.1.10.4 ENCODER SCALING / Encoder sign PIN 13

R

ENCODER SCALING      4  
 13)ENCODER SIGN

R

13)ENCODER SIGN  
 NON-INVERT

Modifies the encoder rotation sign.

PARAMETER	RANGE	DEFAULT	PIN
ENCODER SIGN	NON-INVERT or INVERT	NON-INVERT	13

Use this to invert the encoder feedback sign if needed. Note, in combined feedback modes type 3 and 4, with single line encoders, the feedback sign is automatically taken from the AVF or tachometer if SPINDLE ORIENTATE is not employed. (T16 digital input is made free for other uses).

6.1.11 CALIBRATION / IR compensation PIN 14

**R** CALIBRATION 3  
14)IR COMPENSATION

**R** 14)IR COMPENSATION  
0.00%

Sets % compensation of the AVF signal due to IR drop

PARAMETER	RANGE	DEFAULT	PIN
IR COMPENSATION	0.00 to 100.00%	0.00%	14

This parameter is used when armature voltage speed feedback type is selected or in field weakening mode. Note. Speed is proportional to the back EMF of the motor. Back EMF = AVF – IR drop. Hence when the armature current is high the IR drop is high. At zero armature current the IR drop is zero. To set this parameter with AVF feedback, arrange if possible to apply a significant load change to the system. Slowly increment the parameter until the load change has minimum effect on the speed holding. Alternatively calculate the parameter using the formula below and initially enter this value.

$$\text{IR COMPENSATION (\%)} = \text{RATED MOTOR AMPS} \times \text{Armature resistance} \times 100 / \text{RATED ARM VOLTS.}$$

Note. Excessive compensation may lead to instability.

See also 6.9.6 FIELD CONTROL / FLD WEAKENING MENU for field weakening systems.

6.1.12 CALIBRATION / Field current feedback trim PIN 15

**R** CALIBRATION 3  
15)FIELD CUR FB TRIM

**R** 15)FIELD CUR FB TRIM  
1.0000

Sets a positive trim factor for the field current feedback

PARAMETER	RANGE	DEFAULT	PIN
FIELD CUR FB TRIM	1.0000 to 1.1000	1.0000	15

This trim factor may be applied during drive running. The factor is always greater than unity hence can only increase the strength of the feedback. The closed loop system then receives feedback that is too high and causes a reduction of the controlled field current.

(This trim is useful if the precise 4)RATED FIELD AMPS calibration parameter is not exactly known and must be discovered during running by starting with a higher than expected value. Once the correct level of feedback has been determined using this trim (the DIAGNOSTICS menu can be used to monitor actual levels of feedback), it can then be entered in the 4)RATED FIELD AMPS calibration parameter. This trim may then be returned to 1.000).

6.1.13 CALIBRATION / Armature volts trim PIN 16

**R** CALIBRATION 3  
16)ARM VOLTS TRIM

**R** 16)ARM VOLTS TRIM  
1.0000

Sets a positive trim factor for the armature volts feedback

PARAMETER	RANGE	DEFAULT	PIN
ARM VOLTS TRIM	1.0000 to 1.1000	1.0000	16

This trim factor may be applied during drive running. The factor is always greater than unity hence can only increase the strength of the feedback. The closed loop system then receives feedback that is too high and causes a reduction of the armature voltage feedback and hence a reduction in speed.

(This trim is useful if the precise 18)RATED ARM VOLTS calibration parameter is not exactly known and must be discovered during running by starting with a higher than expected value. Once the correct level of feedback has been determined using this trim, (the DIAGNOSTICS menu can be used to monitor actual levels of feedback), it can then be entered in the 18)RATED ARM VOLTS calibration parameter. This trim may then be returned to 1.000).

6.1.14 CALIBRATION / Analog tacho trim PIN 17

**R** CALIBRATION
3

17)ANALOG TACHO TRIM

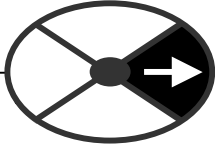

**R** 17)ANALOG TACHO TRIM
1.0000

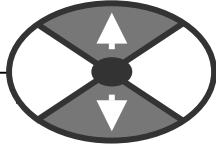

Sets a positive trim factor for the analog tacho feedback

PARAMETER	RANGE	DEFAULT	PIN
ANALOG TACHO TRIM	1.0000 to 1.1000	1.0000	17

This trim factor may be applied during drive running. The factor is always greater than unity hence can only increase the strength of the feedback. The closed loop system then receives feedback that is too high and causes a reduction of the tacho voltage feedback and hence a reduction in speed. (This trim is useful if the precise 8)MAX TACHO VOLTS calibration parameter is not exactly known and must be discovered during running by starting with a higher than expected value. Once the correct level of feedback has been determined using this trim, (monitor actual levels of feedback in the DIAGNOSTICS menu) it can then be entered in the 8)MAX TACHO VOLTS calibration parameter and this trim returned to 1.000).

6.1.15 CALIBRATION / Rated armature volts PIN 18 QUICK START

**R** CALIBRATION
3

18)RATED ARM VOLTS

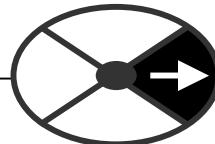

**R** 18)RATED ARM VOLTS
460.0 V DC

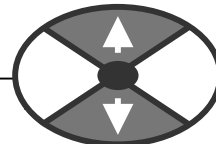

Sets the desired max armature voltage at 100% speed

PARAMETER	RANGE	DEFAULT	PIN
RATED ARM VOLTS	0.0 to 1000.0 VOLTS	460.0 V DC	18

Note. This must not exceed the maximum rated armature volts defined on the motor dataplate. The armature volts is approximately proportional to the motor speed.  
 Example. A motor rated at 400 volts, 2000 rpm, is required to run at a maximum speed of 1000 rpm. Therefore 200 volts will be the rated armature volts at 1000 rpm. This represents 100% speed. Note. At low speeds be aware of heat dissipation in the motor at full torque. Use force venting of the motor if necessary. If desired maximum rpm is higher than the base rpm then implement field weakening in the CHANGE PARAMETERS / FIELD CONTROL menu. **You must however verify that your motor and load are rated for rotation above base speed. Failure to do so may result in mechanical failure with disastrous consequences.** In this mode the rated armature volts is usually set to the dataplate value in order to fully exploit the motor ratings. Further speed increase is provided by field weakening and hence the armature voltage remains clamped at the max rated value. This is referred to in the Field weakening menu as the spillover voltage.

6.1.16 CALIBRATION / EL1/2/3 rated AC volts PIN 19 QUICK START

**R** CALIBRATION
3

19)EL1/2/3 RATED AC

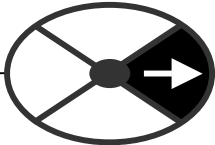

**R** 19)EL1/2/3 RATED AC
415.0 VOLTS

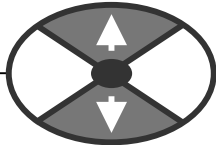

Enter the 3 phase AC supply volts connected to EL1/2/3.

PARAMETER	RANGE	DEFAULT	PIN
EL1/2/3 RATED AC	0 to 1000.0 VOLTS	415.0 VOLTS	19

Note the actual AC volts may be monitored. See 7.7 DIAGNOSTICS / EL1/2/3 RMS MON PIN 169.

The SUPPLY PHASE LOSS alarm uses this parameter to determine the alarm threshold. The loss detection threshold is set at approximately 75% of the voltage entered here. By entering a voltage higher or lower than the rated voltage it is possible to accomodate systems requiring detection at higher or lower thresholds.

Eg.

- With 19)EL1/2/3 RATED AC set to 415V the alarm will detect at 311 volts on EL1/2/3. (75% of 415 = 311)
- With 19)EL1/2/3 RATED AC set to 500V the alarm will detect at 375 volts on EL1/2/3. (75% of 500 = 375)

See 8.1.11.11 DRIVE TRIP MESSAGE / Supply phase loss, also see 3.6 Supply loss shutdown.

## 6.1.17 CALIBRATION / Motor 1 or 2 select PIN 20

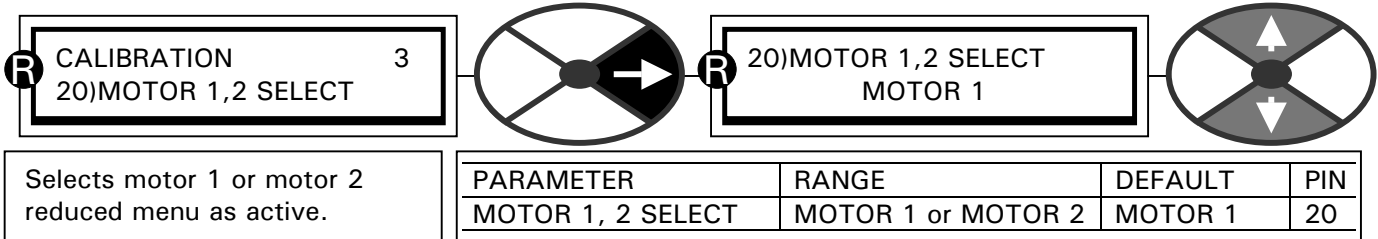

Selects motor 1 or motor 2 reduced menu as active.

All the alterable parameters contained in the CHANGE PARAMETERS reduced menu may have 2 value settings. (MOTOR 1 and MOTOR 2). This window selects the active set. The active set is always the one available in the CHANGE PARAMETERS menu display. The passive set can be viewed and modified in the configuration menu. See 13.13.1 DRIVE PERSONALITY / PASSIVE MOTOR SET.

This PIN can of course be configured to be set by a digital input for external set selection. It may also be used as a diagnostic to show which set is active, and may be connected to a digital output if desired.

Rules of operation.

- 1) Motor 1 and 2 calibration parameters are NOT overwritten if the **factory default** parameters are restored.
- 2) The MOTOR 1, 2 SELECT parameter is NOT overwritten if the **factory default** parameters are restored.

This means that the PL/X default power up (4-KEY RESET) will not affect the **prevailing** calibration parameters. PINs 2 – 20, 100)FIELD VOLTS OP % and 680)Iarm BURDEN OHMS, in both the active set and the passive set. All other parameters are restored to the factory defaults.

See 5.1.3 Restoring the drive parameters to the default condition.

See 4.5.4 PASSIVE MOTOR defaults / Using passive motor menu for small test motors.

See 13.13.2 DRIVE PERSONALITY / Recipe page PIN 677.

There is a class of parameters that are prevented from being altered by the keys during motor running. These are indicated in the PIN number tables at the back of the manual by a letter S (STOP DRIVE TO ADJUST) in the 'Property' column. See 15 PIN number tables.

If 20)MOTOR 1,2 SELECT is altered during running, then any class 'S' parameters in the DRIVE PERSONALITY / PASSIVE MOTOR SET that differ from their counterparts in the ACTIVE set will not become active until the next STOP sequence.

This functionality gives an extra level of safety but still allows dynamic alteration of most of the important parameters, during running, by one digital input.

### 6.2 CHANGE PARAMETERS / RUN MODE RAMPS



PIN numbers range 21 to 35.

A different down ramp time is settable for stopping modes. See 6.5.2 STOP MODE RAMP / Stop ramp time PIN 56.

A different up/down ramp time is settable for JOG control. See 6.3.6 JOG CRAWL SLACK / Jog/Slack ramp PIN 43.

Summary of available functions.

This block sets the rate of acceleration and deceleration of the motor independantly of the incoming reference. There are 4 independent up/down forward/reverse ramp times, and an output indicates that ramping is taking place. The output can be held, or preset to any value with preset commands from various sources for a wide number of applications. The ramp shape can be profiled to a classic S shape for smooth control. See 6.2.13 RUN MODE RAMPS / Ramp S-profile % PIN 32.

See 6.3 CHANGE PARAMETERS / JOG CRAWL SLACK and 6.5 CHANGE PARAMETERS / STOP MODE RAMP. These have their own ramp rate times which override the run mode ramps. The incoming reference can have a minimum speed imposed in either direction. The ramp preset function is momentary in jog mode.

Note that the RUN MODE RAMP may be programmed to be active when the unit is in stop mode. See 6.2.1 RUN MODE RAMPS / Block diagram including JOG. This function is useful in cascaded systems.

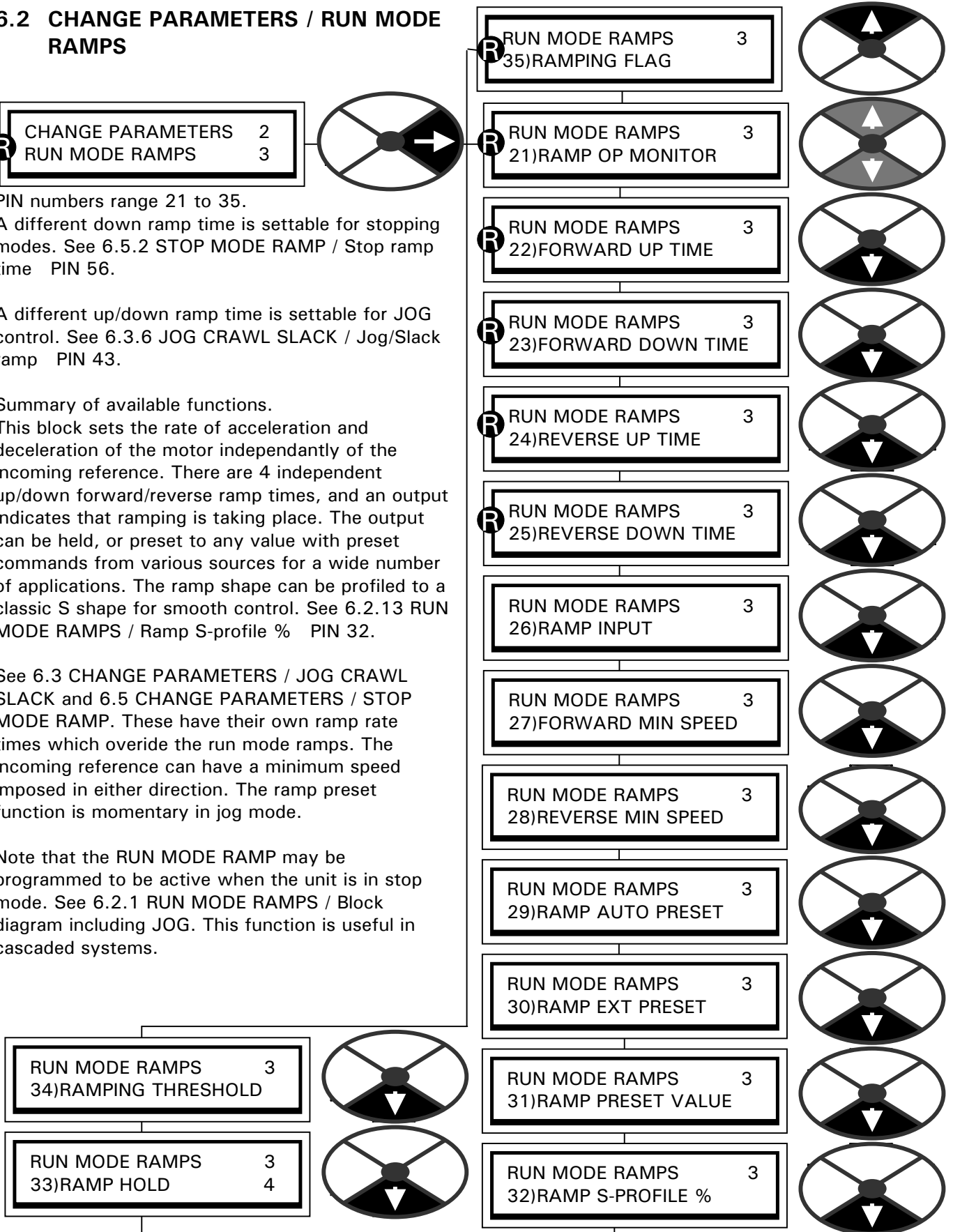

6.2.1 RUN MODE RAMPS / Block diagram including JOG

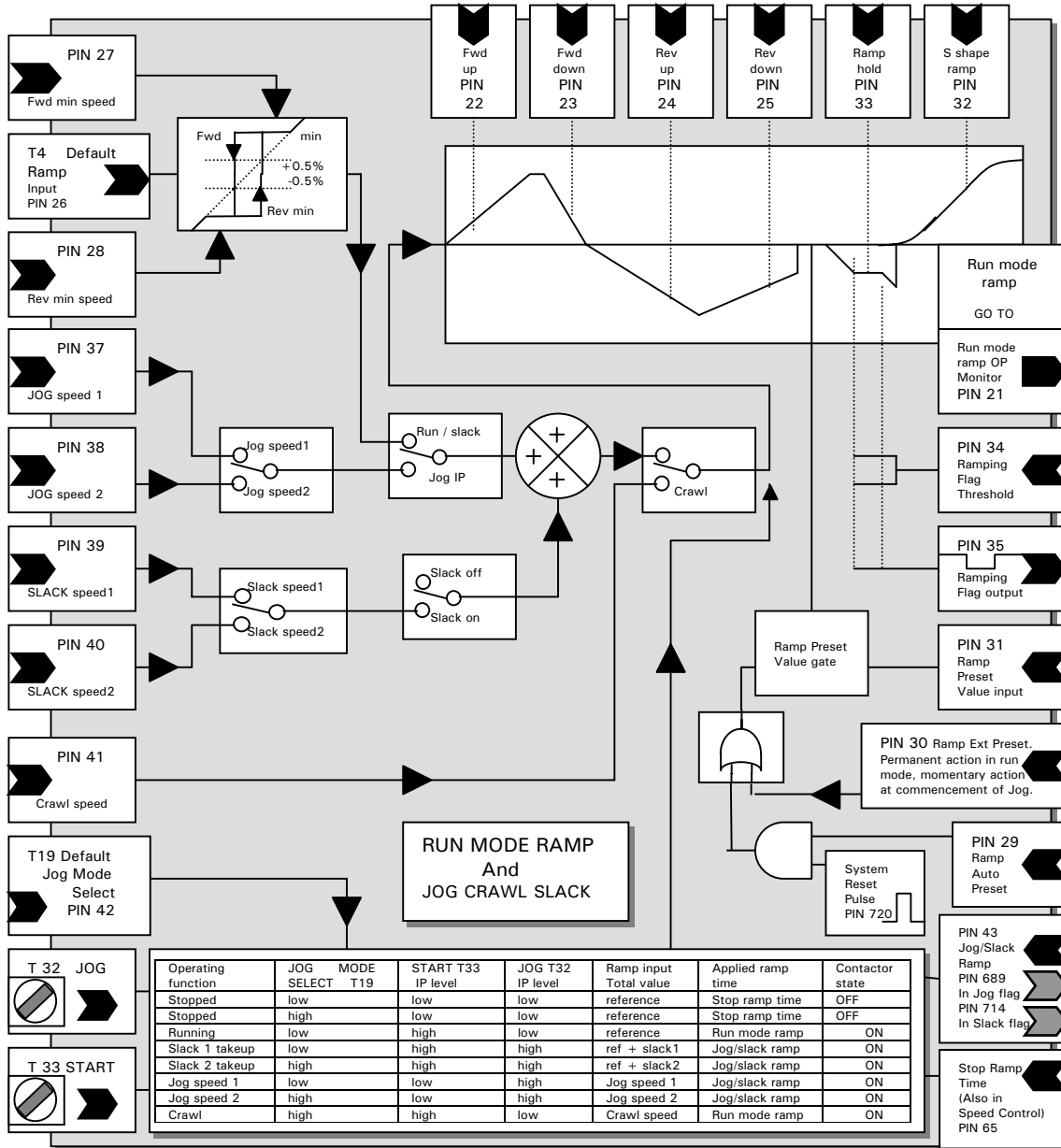

Mode	RAMP AUTO PRESET	RAMP EXT PRESET	RUN MODE RAMP action	JOG MODE RAMP action
1	DISABLED	DISABLED	Held at zero when stopped. <b>Starts from zero.</b>	Held at zero when stopped. <b>Starts from zero.</b>
2	DISABLED	ENABLED	Held at PRESET VALUE permanently.	Held at PRESET VALUE when stopped. <b>Starts from PRESET VALUE</b>
3	ENABLED	DISABLED	Ramp continues to follow input reference when stopped. <b>Starts from PRESET VALUE</b>	Ramp continues to follow input reference when stopped. <b>Starts from PRESET VALUE</b>
4	ENABLED	ENABLED	Held at PRESET VALUE permanently.	Held at PRESET VALUE when stopped. <b>Starts from PRESET VALUE</b>

Mode 1 ensures that the ramp output is reset to 0.00% during all stopping modes.  
 Modes 2/3/4 have an active ramp output during all stopping modes which is useful in cascaded systems. The action of starting, momentarily presets the ramps. (Default value 0.00%).  
 Note. 30)RAMP EXT PRESET has permanent action on the RUN MODE RAMP and, if already high, has a momentary action at the commencement of a JOG request. The 29)RAMP AUTO PRESET input is ANDED with 720)SYSTEM RESET pulse, which is simultaneous with the release of the current loop.



6.2.2 RUN MODE RAMPS / Ramp output monitor PIN 21

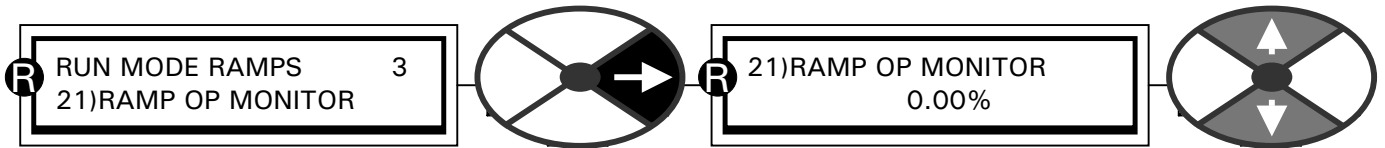

Allows the output level of the ramp block to be monitored.	PARAMETER	RANGE	PIN
	RAMP OP MONITOR	+/-100.00%	21

This monitoring window is able to branch hop to 6.2.16 RUN MODE RAMPS / Ramping flag PIN 35. Note that the RUN MODE RAMP may be active when the unit is in stop mode. See 6.2.1 RUN MODE RAMPS / Block diagram including JOG.

6.2.3 RUN MODE RAMPS / Forward up time PIN 22

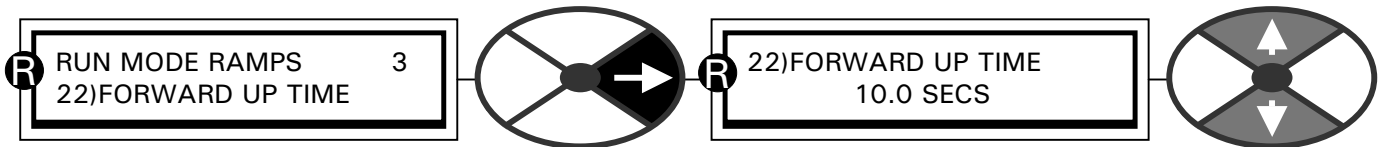

Sets the ramp time for 0-100% of the forward +ve reference.	PARAMETER	RANGE	DEFAULT	PIN
	FORWARD UP TIME	0.1 to 600.0 seconds	10.0 secs	22

6.2.4 RUN MODE RAMPS / Forward down time PIN 23

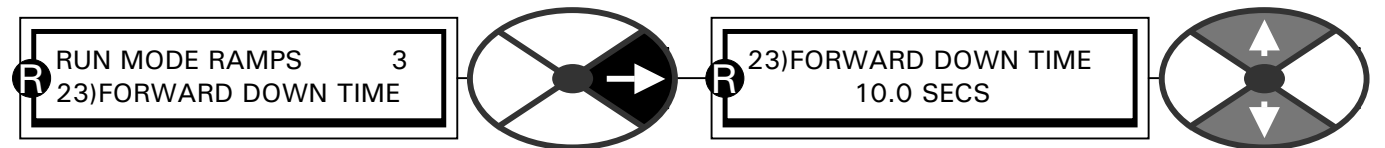

Sets the ramp time for 100-0% of the forward +ve reference.	PARAMETER	RANGE	DEFAULT	PIN
	FORWARD DOWN TIME	0.1 to 600.0 seconds	10.0 secs	23

6.2.5 RUN MODE RAMPS / Reverse up time PIN 24

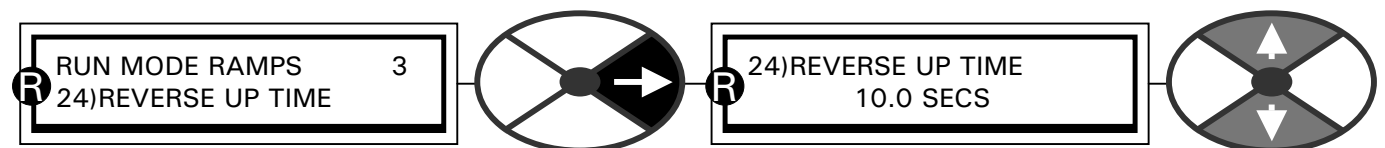

Sets the ramp time for 0-100% of the reverse -ve reference.	PARAMETER	RANGE	DEFAULT	PIN
	REVERSE UP TIME	0.1 to 600.0 seconds	10.0 secs	24

6.2.6 RUN MODE RAMPS / Reverse down time PIN 25

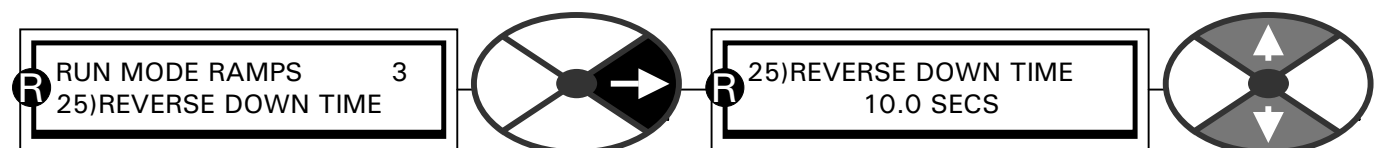

Sets the ramp time for 100-0% of the reverse -ve reference.	PARAMETER	RANGE	DEFAULT	PIN
	REVERSE DOWN TIME	0.1 to 600.0 seconds	10.0 secs	25

## 6.2.7 RUN MODE RAMPS / Ramp input PIN 26

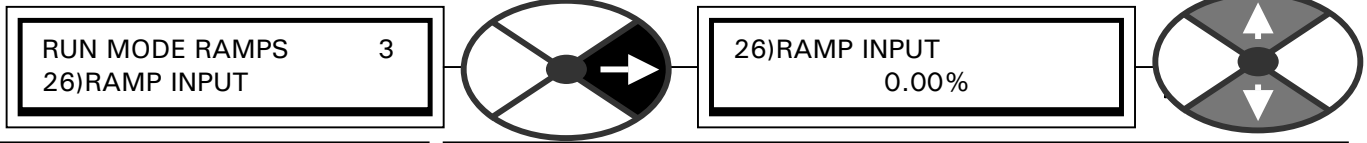

Sets the run mode ramp input value.

PARAMETER	RANGE	DEFAULT	PIN
RAMP INPUT	+/-105.00%	0.00%	26

The factory default connects T4 to PIN 26. This allows an external analogue reference to enter the ramp input value, and then this parameter behaves as a monitor of the ramp input value.

## 6.2.8 RUN MODE RAMPS / Forward minimum speed PIN 27

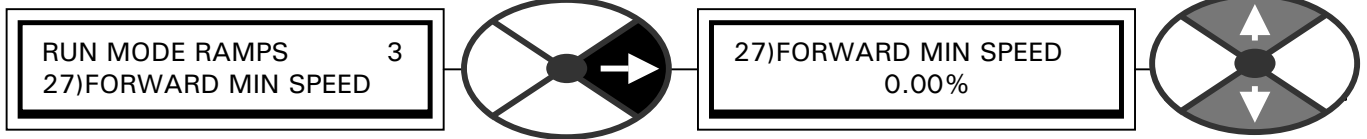

Supports the forward +ve ramp output at a minimum level

PARAMETER	RANGE	DEFAULT	PIN
FWD MIN SPEED	0.00 to +105.00%	0.00%	27

Note that when this parameter is set between 0 and +0.5%, then the ramp output follows the input at the desired ramp rates through zero, i.e. there are no min speeds operating and there is no hysteresis around zero.

Note also that another mode of operation exists when the 27)FORWARD MIN SPEED is greater than 0.5%, AND, 28)REVERSE MIN SPEED is between 0 and -0.5%. (See below). In this case the 27)FORWARD MIN SPEED is operative and the ramp output will not go negative. This facility may be used to prevent accidental negative rotation.

With 27)FORWARD MIN SPEED and 28)REVERSE MIN SPEED outside a band of +/-0.5%, then both minimum speeds will be active with 0.5% hysteresis around zero.

## 6.2.9 RUN MODE RAMPS / Reverse minimum speed PIN 28

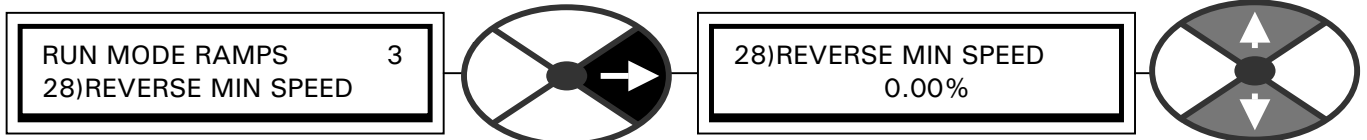

Supports the reverse -ve ramp output at a minimum level.

PARAMETER	RANGE	DEFAULT	PIN
REV MIN SPEED	0 to -105.00%	0.00%	28

Note that when the FORWARD MIN SPEED parameter (see above) is set between 0 and +0.5%, then the ramp output follows the input at the desired ramp rates through zero, i.e. there are no min speeds operating and there is no hysteresis around zero.

Note also that another mode of operation exists when 28)REVERSE MIN SPEED is between 0 and -0.5%, AND, 27)FORWARD MIN SPEED is greater than 0.5%. In this case 27)FORWARD MIN SPEED is operative and the ramp output will not go negative. This facility may be used to prevent accidental negative rotation.

With 27)FORWARD MIN SPEED and 28)REVERSE MIN SPEED outside a band of +/-0.5%, then both minimum speeds will be active with 0.5% hysteresis around zero.

6.2.10 RUN MODE RAMPS / Ramp automatic preset PIN 29

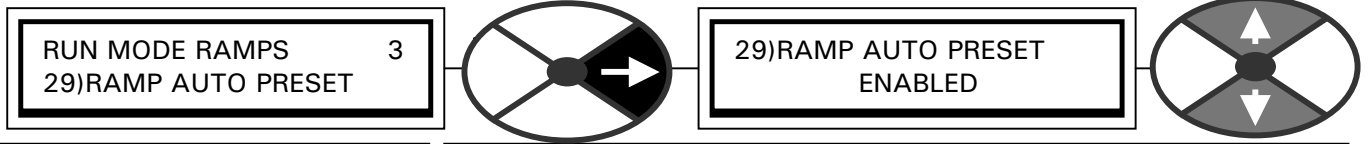

When enabled, the system reset also presets the ramp.

PARAMETER	RANGE	DEFAULT	PIN
RAMP AUTO PRESET	ENABLED or DISABLED	ENABLED	29

The SYSTEM RESET produces a logic pulse (5mS) each time the MAIN CONTACTOR is energised. See 6.2.1 RUN MODE RAMPS / Block diagram including JOG.

6.2.11 RUN MODE RAMPS / Ramp external preset PIN 30

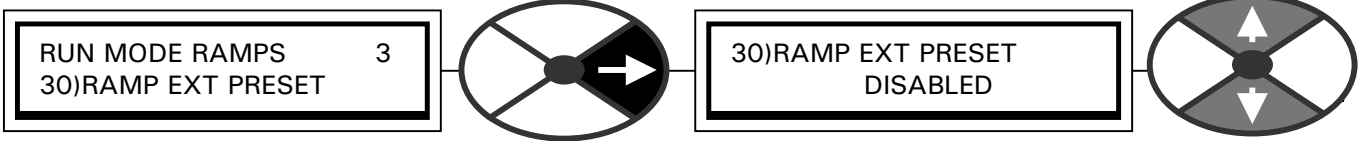

When enabled the ramp is held in preset mode.

PARAMETER	RANGE	DEFAULT	PIN
RAMP EXT PRESET	ENABLED or DISABLED	DISABLED	30

A logic high enables the preset. It is also OR'd with 29)RAMP AUTO PRESET if this is enabled. See 6.2.1 RUN MODE RAMPS / Block diagram including JOG.

6.2.12 RUN MODE RAMPS / Ramp preset value PIN 31

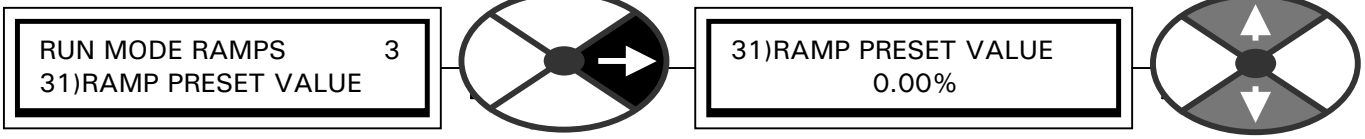

When the ramp is preset this is the value it goes to.

PARAMETER	RANGE	DEFAULT	PIN
RAMP PRESET VALUE	+/-300.00%	0.00%	31

6.2.13 RUN MODE RAMPS / Ramp S-profile % PIN 32

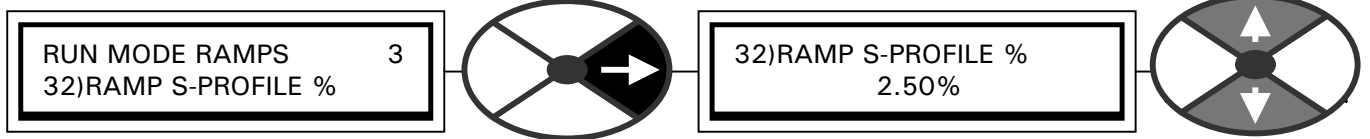

This value sets the % of the S ramp shape at each end

PARAMETER	RANGE	DEFAULT	PIN
RAMP S-PROFILE %	0.00 to 100.00%	2.50%	32

Note. A value of 0.00% will produce a linear ramp. The ramp time will be become longer when the S shape % is increased. This is because the rate of change in the remaining linear portion is maintained.

6.2.14 RUN MODE RAMPS / Ramp hold enable PIN 33

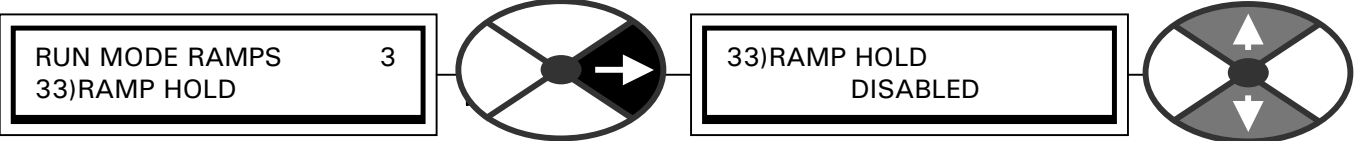

When ENABLED the ramp is held at the present value.

PARAMETER	RANGE	DEFAULT	PIN
RAMP HOLD	ENABLED or DISABLED	DISABLED	33

Note the 30)RAMP EXT PRESET function will override the 33)RAMP HOLD function.

## 6.2.15 RUN MODE RAMPS / Ramping threshold PIN 34

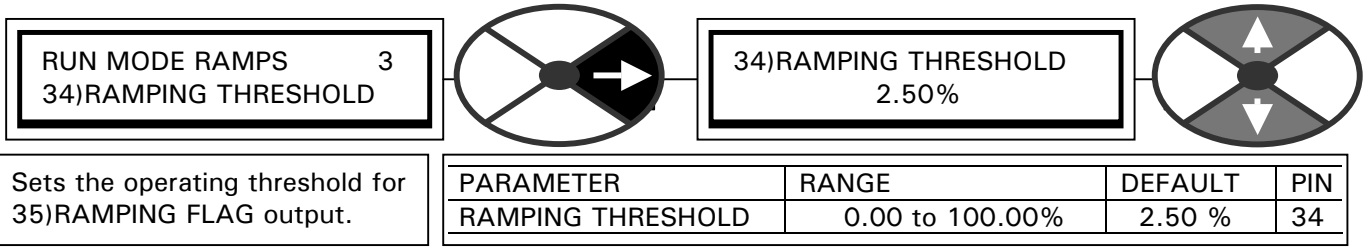

Until the output of the ramp is within this % tolerance of its target value then 35)RAMPING FLAG is high. This is also true if the ramp is being **held** at a value that differs from the input by more than the threshold. See 6.2.16 RUN MODE RAMPS / Ramping flag PIN 35.

## 6.2.16 RUN MODE RAMPS / Ramping flag PIN 35

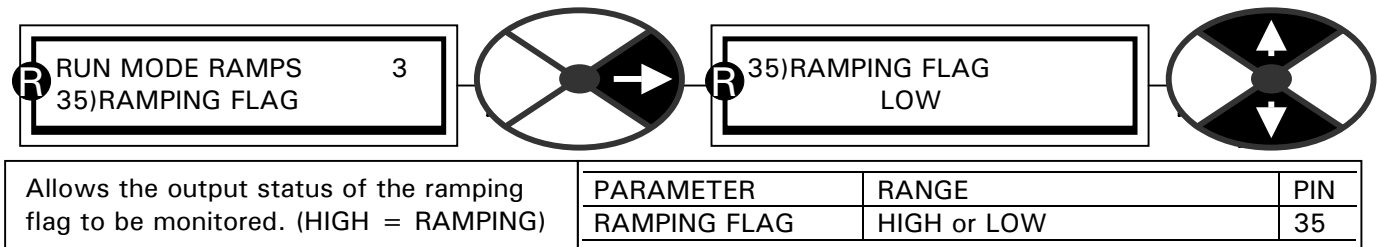

The ramping flag may be used to modify the speed loop integrator during ramping.

See 6.7.7.5 SPEED PI ADAPTION / Integral % during ramp PIN 78.

Note. 78)INT % DURING RAMP does not reset the integrator, it merely alters the % of integration.

For very precise performance at the ramp end points, e. g. stopping, it is useful to be able to RESET the SPEED LOOP integrator during the ramping process. By holding it in RESET during the ramping process there is no undesirable integral history to interfere with the loop at the end of the ramp.

This RESET can be achieved by connecting a JUMPER from 35)RAMPING FLAG to 73)SPEED INT RESET.

See 13.2.4 JUMPER connections.

This monitoring window is able to branch hop to 6.2.2 RUN MODE RAMPS / Ramp output monitor PIN 21.

Digital output DOP2 on terminal 23 is connected by default to the 35)RAMPING FLAG.

### 6.3 CHANGE PARAMETERS / JOG CRAWL SLACK

JOG / CRAWL / SLACK PIN numbers range 37 to 43.

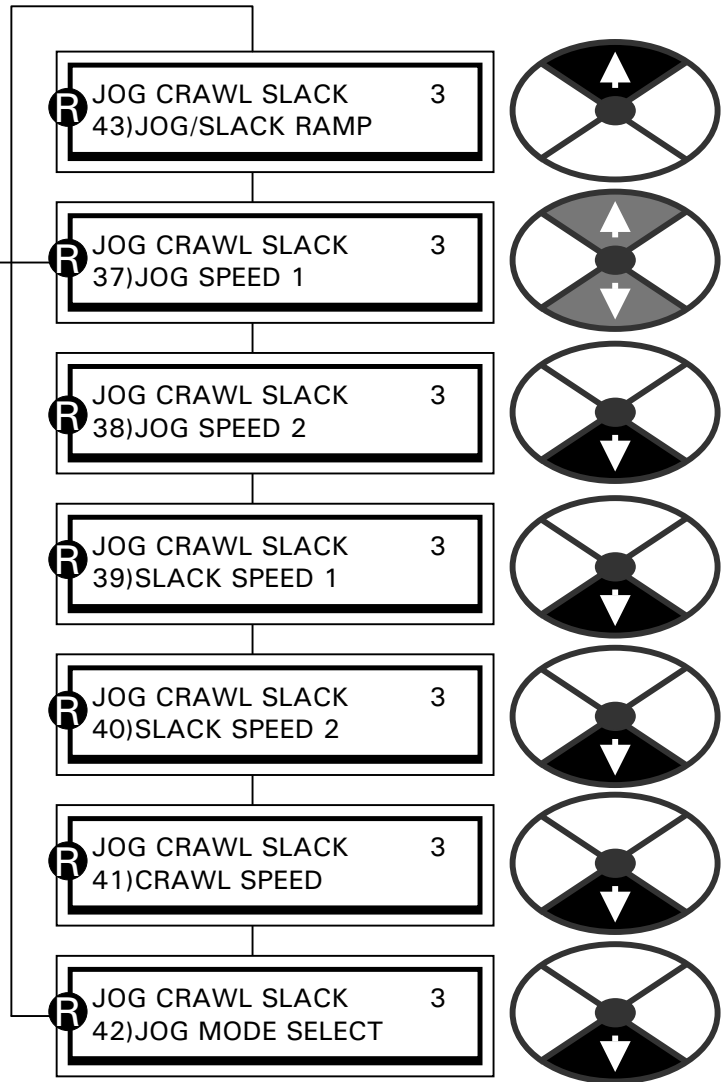
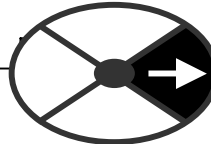

This menu provides adjustment for parameters associated with jogging, slack take up and crawling.

See 6.3.5 JOG CRAWL SLACK / Jog mode select PIN 42. This gives a table showing the 8 modes of operation available.

There are 2 hidden PINs that provide output flags as follows

689)IN JOG FLAG.

This is high during the jogging process, it goes low after the ramp has returned to the prevailing run level.

714)IN SLACK FLAG.

This is high during the slack take up process, it goes low after the ramp has returned to the prevailing run level.

This flag is useful in centre winding applications for controlling the tension enable. See APPLICATIONS MANUAL.

6.3.1 JOG CRAWL SLACK / Block diagram including RUN MODE RAMPS

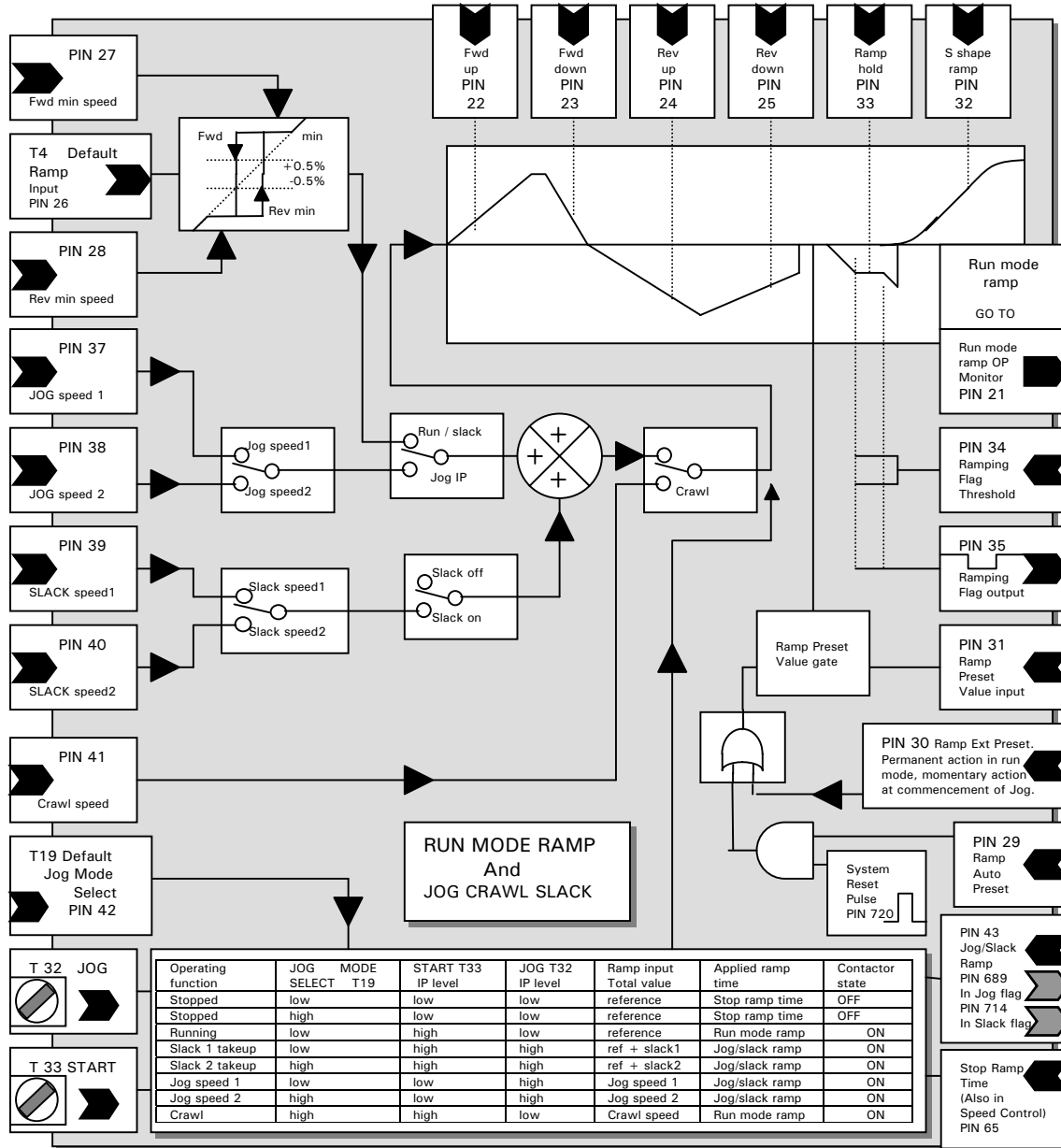

Mode	RAMP AUTO PRESET	RAMP EXT PRESET	RUN MODE RAMP action	JOG MODE RAMP action
1	DISABLED	DISABLED	Held at zero when stopped. <b>Starts from zero.</b>	Held at zero when stopped. <b>Starts from zero.</b>
2	DISABLED	ENABLED	Held at PRESET VALUE permanently.	Held at PRESET VALUE when stopped. <b>Starts from PRESET VALUE</b>
3	ENABLED	DISABLED	Ramp continues to follow input reference when stopped. <b>Starts from PRESET VALUE</b>	Ramp continues to follow input reference when stopped. <b>Starts from PRESET VALUE</b>
4	ENABLED	ENABLED	Held at PRESET VALUE permanently.	Held at PRESET VALUE when stopped. <b>Starts from PRESET VALUE</b>

Mode 1 ensures that the ramp output is reset to 0.00% during all stopping modes. Modes 2/3/4 have an active ramp output during all stopping modes which is useful in cascaded systems. The action of starting momentarily presets the ramps. (Default value 0.00%). Note. 30)RAMP EXT PRESET has permanent action on the RUN MODE RAMP and, if already high, has a momentary action at the commencement of a JOG request. The 29)RAMP AUTO PRESET input is ANDED with 720)SYSTEM RESET pulse, which is simultaneous with the release of the current loop.

6.3.2 JOG CRAWL SLACK / Jog speed 1 / 2 PINs 37 / 38

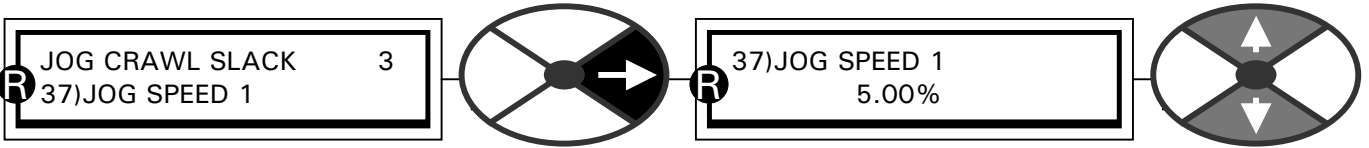

PARAMETER	RANGE	DEFAULT	PIN
JOG SPEED 1	+/-100.00%	5.00%	37

Sets the value of jog speed 1  
Usually used for forward jog.

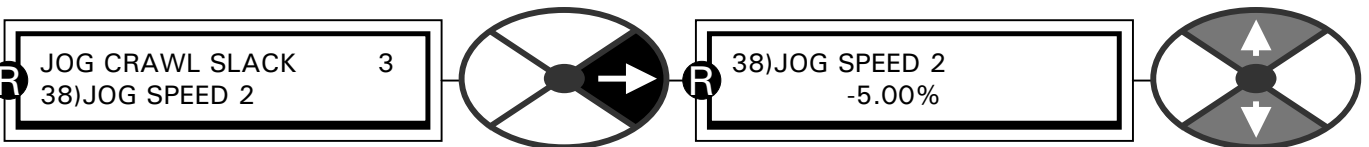

PARAMETER	RANGE	DEFAULT	PIN
JOG SPEED 2	+/-100.00%	-5.00%	38

Sets the value of jog speed 2  
Usually used for reverse jog.

6.3.3 JOG CRAWL SLACK / Slack speed 1 / 2 PINs 39 / 40

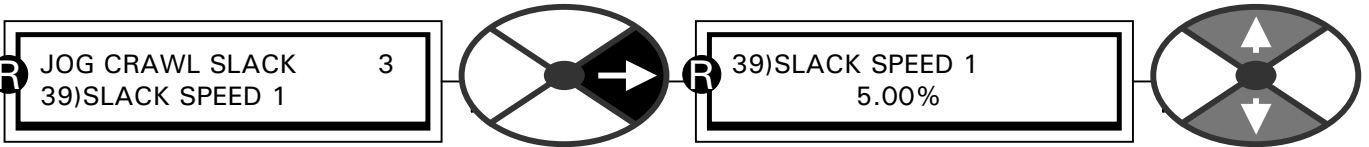

PARAMETER	RANGE	DEFAULT	PIN
SLACK SPEED 1	+/-100.00%	5.00%	39

Sets the value of slack speed 1  
Usually used for forward slack.

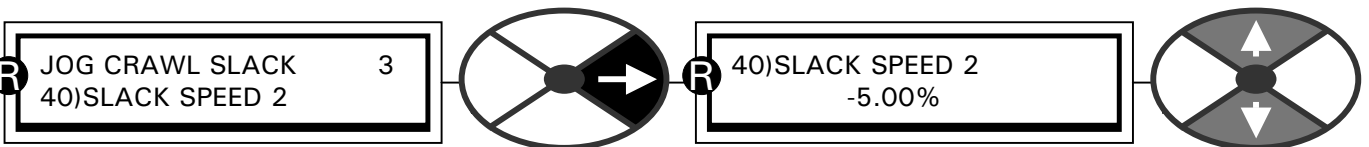

PARAMETER	RANGE	DEFAULT	PIN
SLACK SPEED 2	+/-100.00%	-5.00%	40

Sets the value of slack speed 2  
Usually used for reverse slack.

6.3.4 JOG CRAWL SLACK / Crawl speed PIN 41

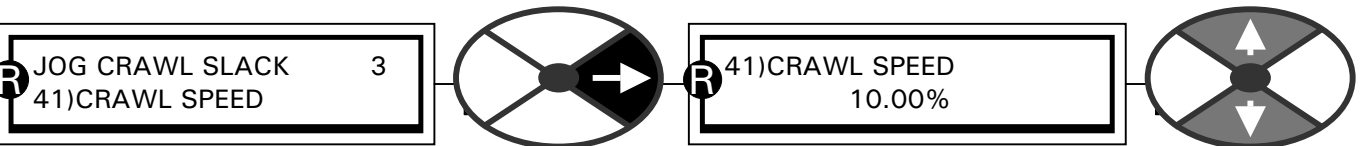

PARAMETER	RANGE	DEFAULT	PIN
CRAWL SPEED	+/-100.00%	10.00%	41

Sets the value of crawl speed.

6.3.5 JOG CRAWL SLACK / Jog mode select PIN 42

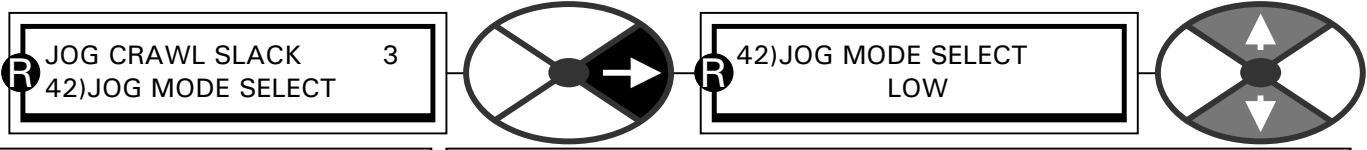

Combines with the JOG/START inputs for jog/crawl/slack mode

PARAMETER	RANGE	DEFAULT	PIN
JOG MODE SELECT	LOW or HIGH	LOW	42

The factory default for JOG MODE SELECT is an external connection to T19.

Operating function	JOG MODE SELECT T19 IP level	START T33 IP level	JOG T32 IP level	Ramp input Total value	Applied ramp time	Contactors state
Stopped	low	low	low	reference	Stop ramp	OFF
Stopped	high	low	low	reference	Stop ramp	OFF
Running	low	high	low	reference	Run mode ramp	ON
Slack 1 takeup	low	high	high	ref + slack 1	Jog/slack ramp	ON
Slack 2 takeup	high	high	high	ref + slack 2	Jog/slack ramp	ON
Jog speed 1	low	low	high	Jog speed 1	Jog/slack ramp	ON
Jog speed 2	high	low	high	Jog speed 2	Jog/slack ramp	ON
Crawl	high	high	low	Crawl speed	Run mode ramp	ON

6.3.6 JOG CRAWL SLACK / Jog/Slack ramp PIN 43

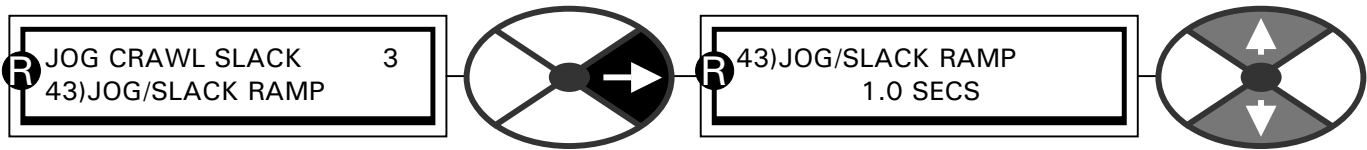

Jog/slack mode has this ramp time which overrides any others

PARAMETER	RANGE	DEFAULT	PIN
JOG/SLACK RAMP	0.1 to 600 seconds	1.00 secs	43

Note. The ramp time is the same for up/down and forward/reverse. It is the time taken to reach 100% speed.



### 6.4 CHANGE PARAMETERS / MOTORISED POT RAMP

PIN number range 45 to 54



This menu controls the parameters for the motorised pot (MP) function. This is the default terminal function for terminals T6, T7, T8.

The motorised pot is a ramp facility in addition to the normal reference ramp.

It may also be used to ramp a parameter other than the speed reference by re-configuring its output connection.

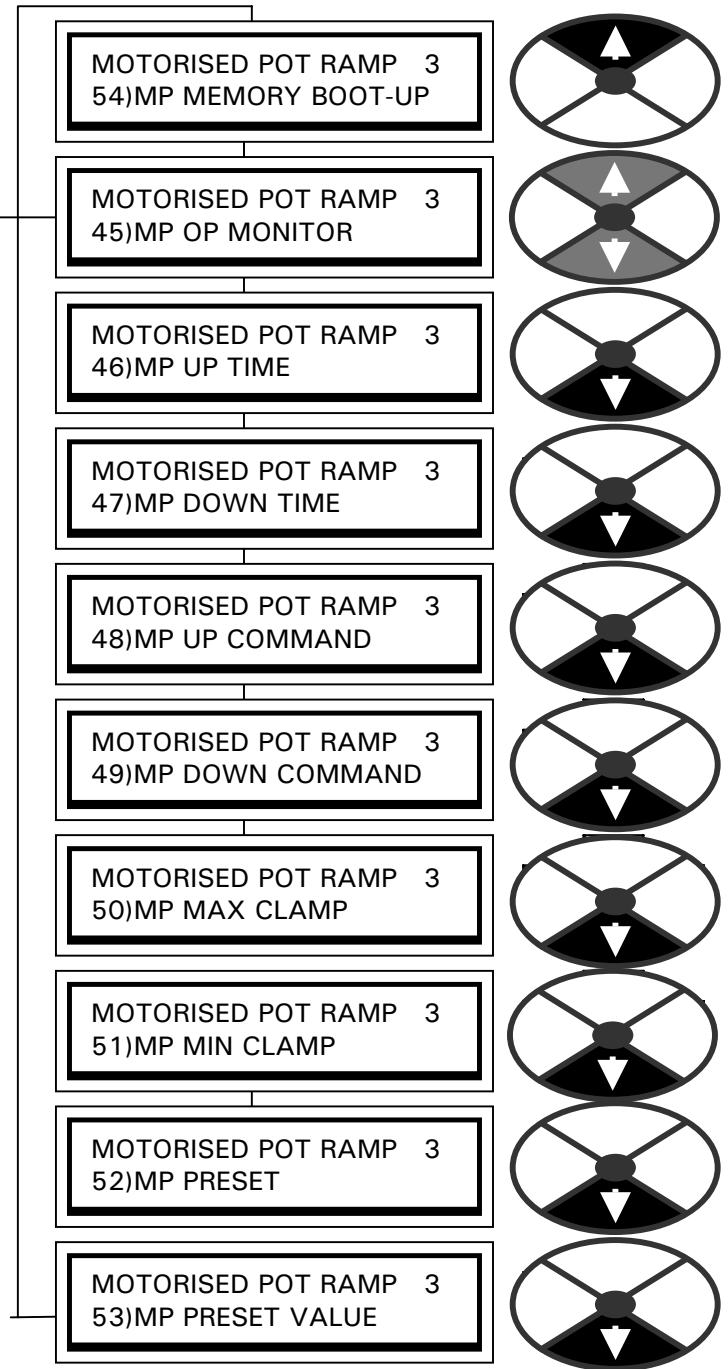

6.4.1 MOTORISED POT RAMP / Block diagram

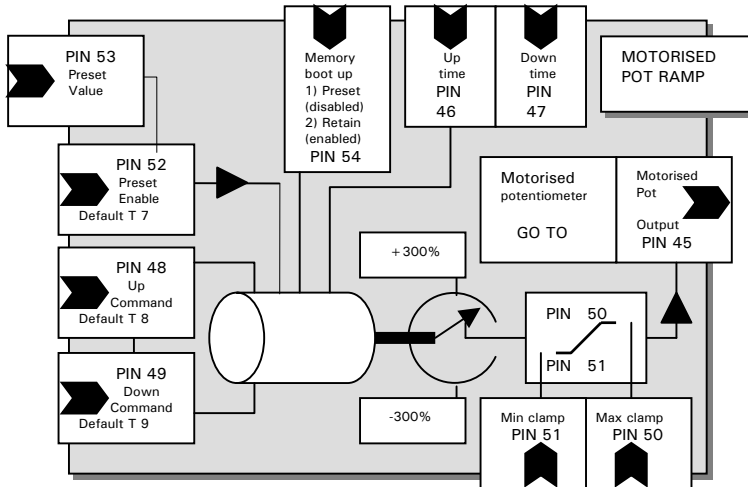

6.4.2 MOTORISED POT RAMP / MP output monitor PIN 45

MOTORISED POT RAMP 3  
45)MP OP MONITOR

45)MP OP MONITOR  
0.00%

PARAMETER	RANGE	PIN
MP OP MONITOR	+/-300.00%	45

Allows the output value of the motorized pot to be monitored.

Default connection to speed reference summer. See 6.6.2 SPEED REF SUMMER / Internal speed reference 1 PIN 62.

6.4.3 MOTORISED POT RAMP / MP Up / Down time PINs 46 / 47

MOTORISED POT RAMP 3  
46)MP UP TIME

46)MP UP TIME  
10.0 SECS

PARAMETER	RANGE	DEFAULT	PIN
MP UP TIME	0.1 to 600.0	10.0 secs	46

Sets the ramp time for 100% clockwise (+ve) rotation.

MOTORISED POT RAMP 3  
47)MP DOWN TIME

47)MP DOWN TIME  
10.0 SECS

PARAMETER	RANGE	DEFAULT	PIN
MP DOWN TIME	0.1 to 600.0	10.0 secs	47

Sets the ramp time for -100% anticlockwise (-ve) rotation.

6.4.4 MOTORISED POT RAMP / MP Up / Down command PINs 48 / 49

**MOTORISED POT RAMP 3**  
48)MP UP COMMAND

48)MP UP COMMAND  
DISABLED

Enables the motorised pot to rotate toward the positive limit

PARAMETER	RANGE	DEFAULT	PIN
MP UP COMMAND	ENABLED or DISABLED	DISABLED	48

**MOTORISED POT RAMP 3**  
49)MP DOWN COMMAND

49)MP DOWN COMMAND  
DISABLED

Enables the motorised pot to rotate toward the negative limit

PARAMETER	RANGE	DEFAULT	PIN
MP DOWN COMMAND	ENABLED or DISABLED	DISABLED	49

Default connections to terminal 8 (Up) and terminal 9 (Down).

Note. There is no ramping with Up and Down enabled together.

6.4.5 MOTORISED POT RAMP / MP Maximum / minimum clamps PINs 50 / 51

**MOTORISED POT RAMP 3**  
50)MP MAX CLAMP

50)MP MAX CLAMP  
100.00%

Sets the limit of positive (cw) rotation of the motorised pot.

PARAMETER	RANGE	DEFAULT	PIN
MP MAX CLAMP	+/-300.00%	100.00%	50

**MOTORISED POT RAMP 3**  
51)MP MIN CLAMP

51)MP MIN CLAMP  
-100.00%

Sets the limit of negative (acw) rotation of the motorised pot.

PARAMETER	RANGE	DEFAULT	PIN
MP MIN CLAMP	+/-300.00%	-100.00%	51

Note. Clockwise rotation is towards the +ve limit, anticlockwise rotation is towards the -ve limit. Always ensure the clamps allow some movement between them, do not let the clamps cross each other.

6.4.6 MOTORISED POT RAMP / MP preset PIN 52

**MOTORISED POT RAMP 3**  
52)MP PRESET

52)MP PRESET  
DISABLED

When enabled, the output is set to the MP PRESET VALUE.

PARAMETER	RANGE	DEFAULT	PIN
MP PRESET	ENABLED or DISABLED	DISABLED	52

Default connection from terminal 7, UIP7.

If a momentary preset at start of running is required, connect a jumper from 720)SYSTEM RESET to 376)UIP7 LO VAL OP1). This causes the system reset pulse to be OR'd with terminal 7.

See 13.2.4 JUMPER connections.

## 6.4.7 MOTORISED POT RAMP / MP Preset value PIN 53

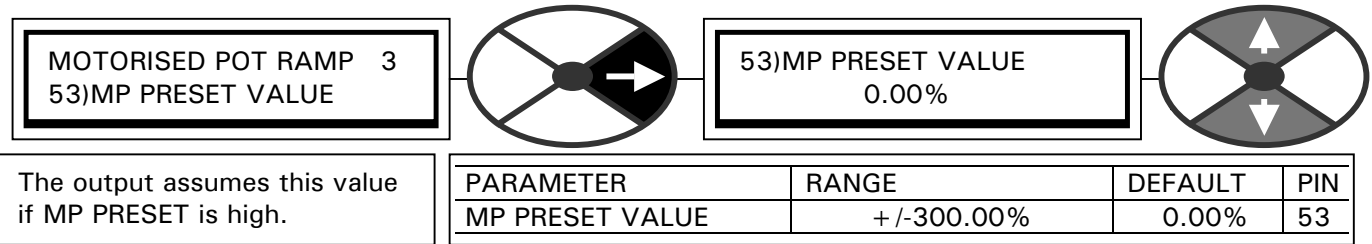

Note. 50)MP MAX CLAMP and 51)MP MIN CLAMP will override the output value if it lies outside the clamps.

## 6.4.8 MOTORISED POT RAMP / MP memory boot up PIN 54

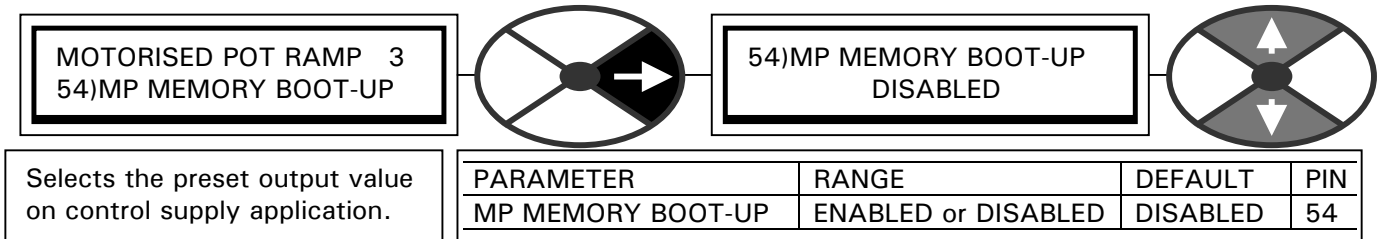

A motorised pot is a device that may be used to remember its setting in the event of a power loss.

**DISABLED.** Used to set the value of the output on control supply power up to 53)MP PRESET VALUE.

**ENABLED.** Used to memorise the value of the output during loss of the control supply, and preset the output with this value on power up of the control supply.

### 6.5 CHANGE PARAMETERS / STOP MODE RAMP

PIN numbers range 56 to 60

This menu allows setting of the contactor drop out behaviour.

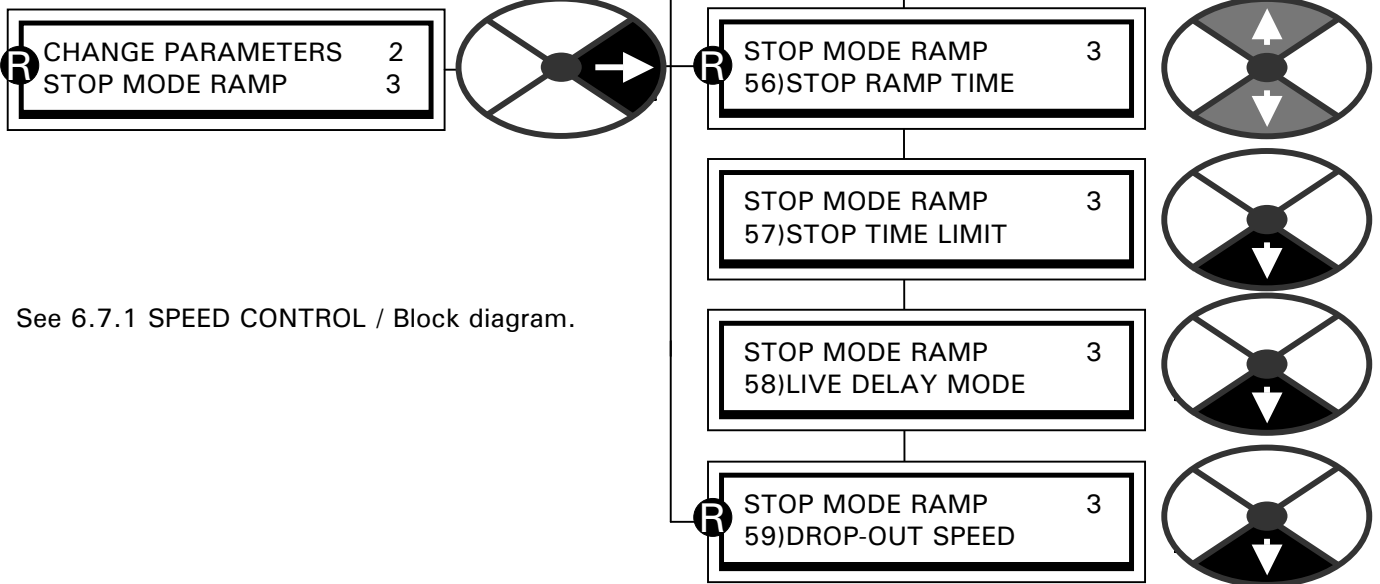

See 6.7.1 SPEED CONTROL / Block diagram.

#### 6.5.1 STOP MODE RAMP / Block diagram

Operating function	JOG MODE SELECT T19 IP level	START T33 IP level	JOG T32 IP level	Ramp input Total value	Applied ramp time	Contactor state
Stopped	low	low	low	reference	Stop ramp	OFF
Stopped	high	low	low	reference	Stop ramp	OFF
Running	low	high	low	reference	Run mode ramp	ON
Slack 1 takeup	low	high	high	ref + slack 1	Jog/slack ramp	ON
Slack 2 takeup	high	high	high	ref + slack 2	Jog/slack ramp	ON
Jog speed 1	low	low	high	Jog speed 1	Jog/slack ramp	ON
Jog speed 2	high	low	high	Jog speed 2	Jog/slack ramp	ON
Crawl	high	high	low	Crawl speed	Run mode ramp	ON

This table shows when the STOP MODE RAMP is applied.

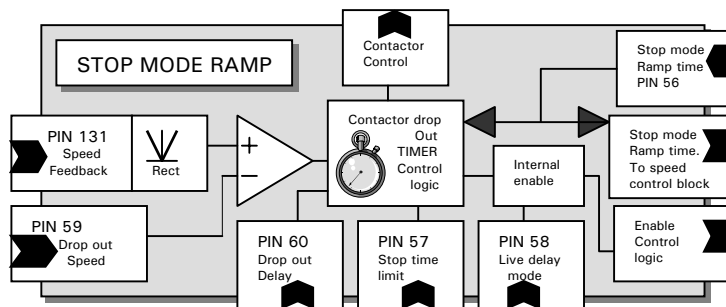

6.5.1.1 Block diagram of contactor control

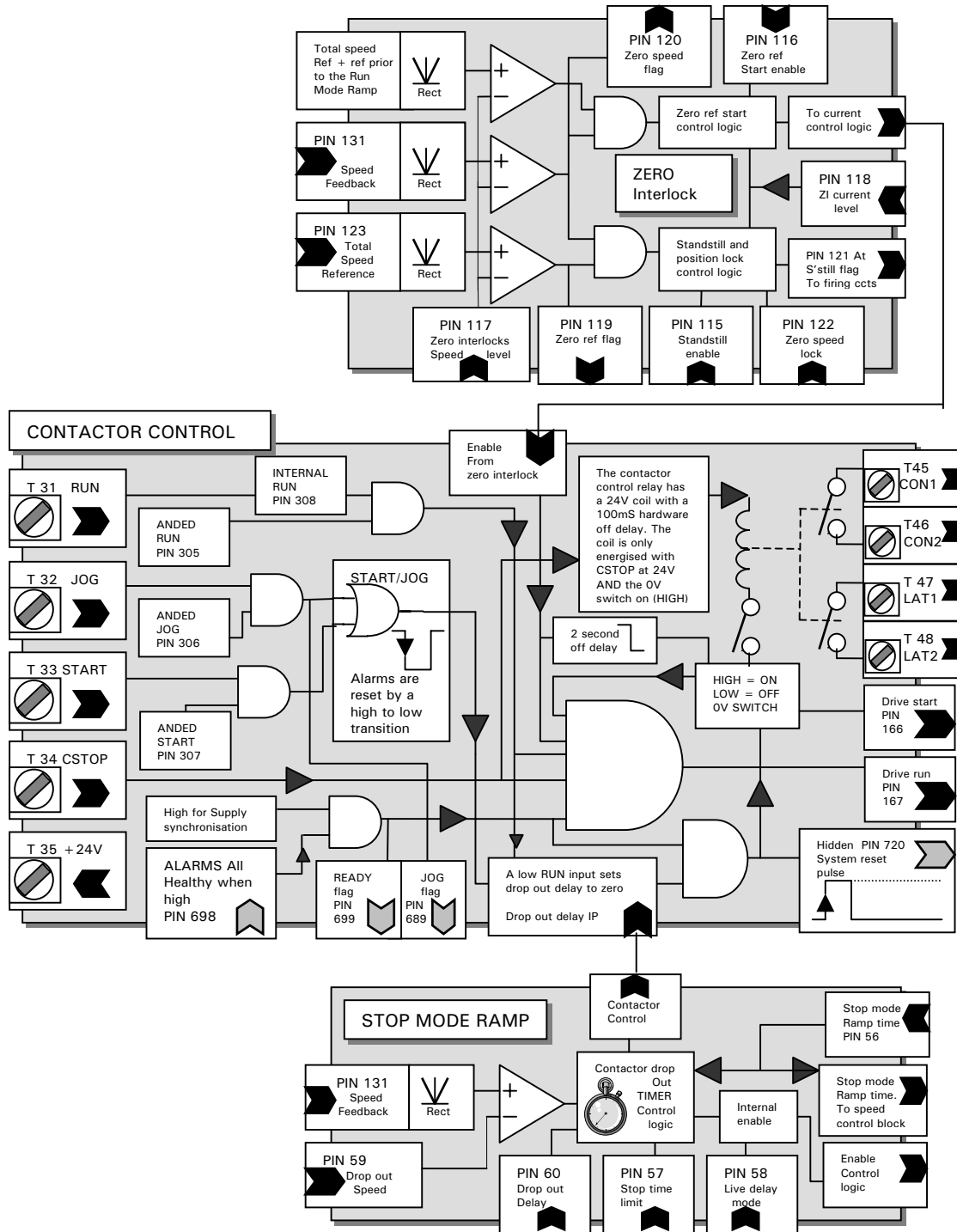

The following conditions must be true for the main contactor to be energised.

- 1) All alarms AND supply synchronisation healthy. ( 699)READY FLAG ).
- 2) CSTOP at 24V. **Note. The CSTOP must be high for at least 50mS prior to START going high.**
- 3) Start OR Jog high.

When the contactor has energised, the drive will run if RUN input is high **AND** if enabled, the ZERO INTERLOCK is satisfied.

The contactor will de-energise after approximately 100 milliseconds if 699)READY FLAG goes low **OR** CSTOP goes low

If the zero interlock is enabled and requests a non-run action, then the contactor will energise for approximately 2 seconds but no current will flow. The contactor will drop out if the zero reference interlock condition is not satisfied within approximately 2 seconds. The display will show CONTACTOR LOCK OUT.

The contactor will de-energise if START and JOG are both low. In this case the time taken for the contactor to de-energise depends on the STOP MODE RAMP when stopping from a running mode, or JOG/SLACK RAMP when stopping from a jog mode.

Note flags on hidden PINs, 689)IN JOG FLAG, 698)HEALTHY FLAG, 699)READY FLAG, 714)IN SLACK FLAG, 720)SYSTEM RESET pulse.

6.5.1.2 Speed profile when stopping

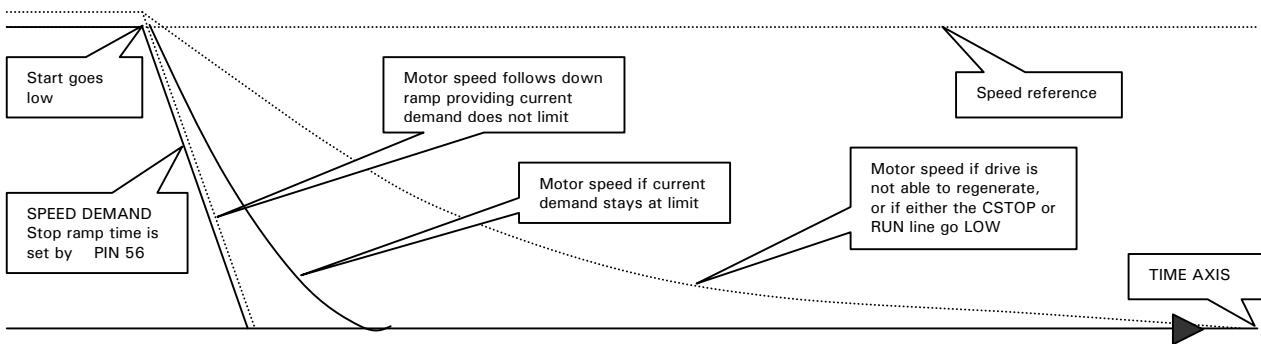

6.5.1.3 Contactor drop out

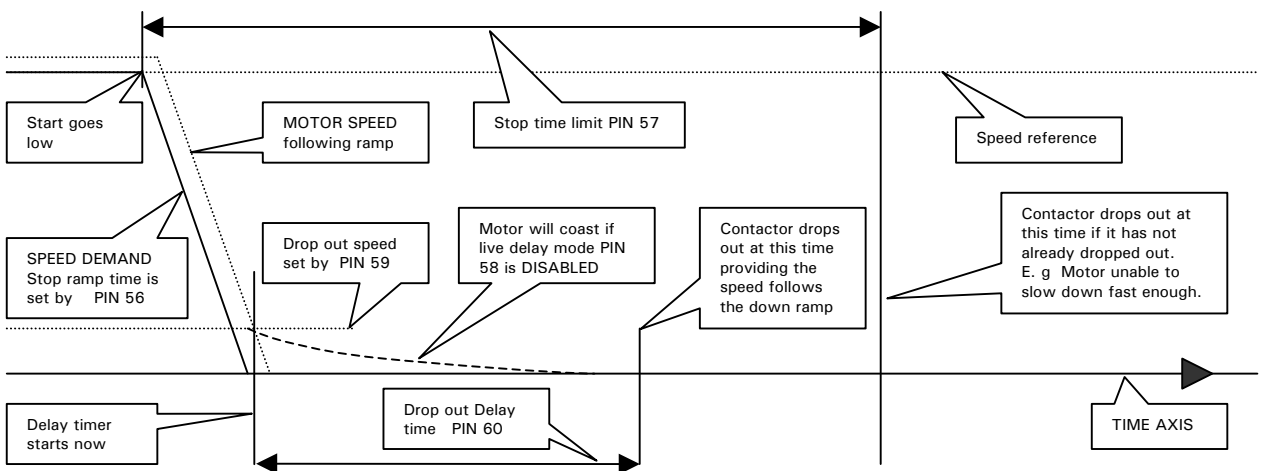

If START or JOG goes high during the 60)DROP-OUT DELAY time, then the contactor stays energised and the drive will restart immediately. The 60)DROP-OUT DELAY timer will be reset to time zero. This allows jogging without the contactor dropping in and out.

The configuration of the PL/X power terminals using L1/2/3 for stack and EL1/2/3 for field and synchronisation is very versatile. This allows the main contactor to be arranged in numerous ways.

- 1) EL1/2/3 permanently energised with contactor on L1/2/3 gives very fast starting and allows the field to remain energised. (Required for dynamic braking or to prevent condensation in cold climates).
  - 2) EL1/2/3 and L1/2/3 energised with main contactor allows total electrical isolation of the motor.
  - 3) Main contactor on armature terminals for dynamic braking/isolation of motor.
  - 4) L1/2/3 may be used at a very low voltage. E. g. using drive as battery charger.
- See 4.3 Main contactor wiring options.

6.5.1.4 Precise stopping

For very precise performance at the ramp end points, e. g. stopping, it is useful to be able to RESET the SPEED LOOP integrator during the ramping process. By holding it in RESET during the ramping process there is no undesirable integral term history to interfere with the loop at the end of the ramp. This RESET can be achieved by connecting a JUMPER from 35)RAMPING FLAG to 73)SPEED INT RESET. See 13.2.4 JUMPER connections.

In addition, ensure that there are no small demand signals entering the speed loop by disconnecting unwanted inputs to the SPEED REFERENCE SUMMER and setting 6.6.7 SPEED REF SUMMER / Speed/Current Reference 3 ratio PIN 67 to zero.

Also it may be useful to have 6.7.7.1 SPEED PI ADAPTION / Low break point PIN 74 set to 0.2% and 6.7.7.3 SPEED PI ADAPTION / Low breakpoint proportional gain PIN 76 set low (e. g. 5.00) to minimise the effects of tachometer noise at the stopping point. See also 6.10.8.1 Low speed performance.

6.5.2 STOP MODE RAMP / Stop ramp time PIN 56

Sets the 100 - 0% down ramp time in normal stop mode

PARAMETER	RANGE	DEFAULT	PIN
STOP RAMP TIME	0.1 to 600.0 secs	10.0 secs	56

A standard 4 quadrant drive can motor and brake in both forward and reverse. It can also stop very quickly by returning mechanical rotational energy to the supply. It does this by effectively using the motor as a generator and the supply as a load to dump the energy in.

A standard 2 quadrant drive can only motor in the forward direction, and cannot regenerate when stopping.

Selected models in the PL 2 quadrant range have a special feature which allows them to regenerate when stopping. This feature not only saves considerable amounts of energy but also eliminates the requirement for dynamic braking resistor systems. See 3.3.1 Regenerative stopping with PL models.

6.5.3 STOP MODE RAMP / Stop time limit PIN 57

Sets the max time limit before contactor drop out in stop mode

PARAMETER	RANGE	DEFAULT	PIN
STOP TIME LIMIT	0.0 to 600.0 secs	60.0 secs	57

This is initiated by the start input going low.



6.5.4 STOP MODE RAMP / Live delay mode PIN 58

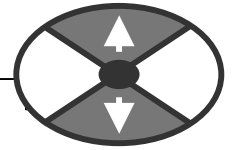
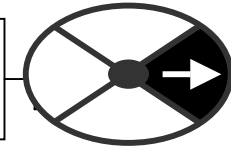
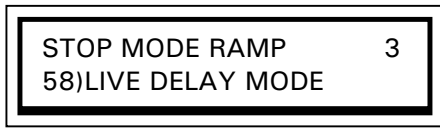

Enables the drive during the drop out delay time

PARAMETER	RANGE	DEFAULT	PIN
LIVE DELAY MODE	ENABLED OR DISABLED	DISABLED	58

This is used when the drive must remain enabled during the period of time when the contactor drop out delay timer is running. E. g. when an external force is trying to rotate the load and this is undesirable, or a final shaft positioning routine is operating. See 6.10.9 ZERO INTERLOCKS / SPINDLE ORIENTATE.

See also 6.10 CHANGE PARAMETERS / ZERO INTERLOCKS for details of other zero speed functions.

A change of this parameter during the drop-out delay time is not effected until the next contactor drop-out.

6.5.5 STOP MODE RAMP / Drop-out speed PIN 59

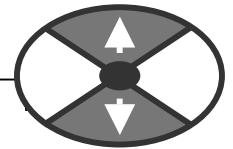
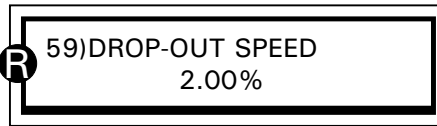
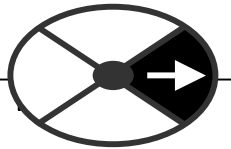

Sets the speed level at which the drop out delay timer starts.

PARAMETER	RANGE	DEFAULT	PIN
DROP-OUT SPEED	0.00 to 100.00%	2.00%	59

Note. If this parameter is set to 100% then the drop out delay timer will commence with the STOP command rather than waiting to reach a low speed. The level is symmetrical for forward and reverse rotation.

6.5.6 STOP MODE RAMP / Drop-out delay PIN 60

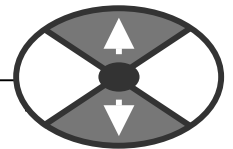
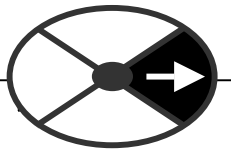

Adds a time delay to the contactor drop out command.

PARAMETER	RANGE	DEFAULT	PIN
DROP-OUT DELAY	0.1 to 600.0 secs	1.0 secs	60

This function is normally used to prevent frequent contactor dropouts during jogging. It works by adding a time delay to the function that tells the main contactor to de-energise. The timer is started when the motor reaches 59)DROP-OUT SPEED threshold. If the drive is restarted before the contactor finally drops out then the timer is reset, ready to start again.

**If the RUN input goes low at any point during the stopping process, either heading for zero speed or during the delay period, then the contactor will drop out straight away.**

During the timer sequence the drive loops are inhibited to prevent the motor from making small unwanted movements. This can be over-riden using 58)LIVE DELAY MODE if the system is required to maintain power while waiting for drop out. E. g. when an external force is trying to rotate the load and this is undesirable, or a final shaft positioning routine is operating. See 6.10.9 ZERO INTERLOCKS / SPINDLE ORIENTATE.

See also 6.10 CHANGE PARAMETERS / ZERO INTERLOCKS for details of other zero speed functions.

### 6.6 CHANGE PARAMETERS / SPEED REF SUMMER

PIN numbers range 62 to 67

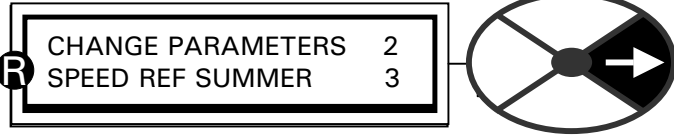

The block diagram below shows the signal paths for the speed loop error amplifier. There are 4 speed reference inputs.

Connections. (62, 63, 65 may be re-programmed)  
 Motorised potentiometer to 62)INT SPEED REF 1.  
 UIP2/T2 To 63)SPEED REF 2  
 UIP4/T4 - Run mode ramp to 65)RAMPED SPD REF 4  
 UIP3/T3 Internally connected to 64)SPEED REF3 MON

64)SPEED REF 3 MON is a monitor of UIP3 only when it is being used as a speed ref with speed bypass disabled. . It may be inverted and/or scaled if desired. It is sampled rapidly to give maximum response. See 6.8.14 CURRENT CONTROL / Speed bypass current reference enable PIN 97 .  
 Note. The STOP command overrides and disables the speed bypass mode. This ensures a controlled stop to zero speed when using the speed bypass mode.

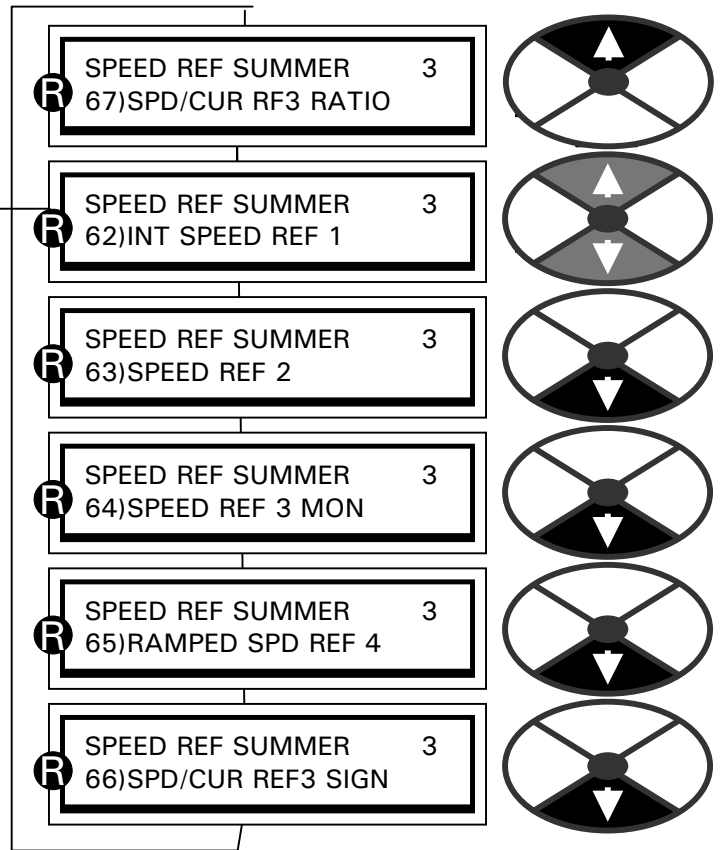

The inputs are summed and then subjected to programmable maximum +ve and -ve clamps. The output after the clamps is the final speed reference which is available to be monitored. This is selected during normal running. During a stop sequence this is reset to zero at the programmed STOP rate. See 6.2 CHANGE PARAMETERS / RUN MODE RAMPS for information about the run mode ramp resetting functions. The stop ramp is released immediately when running is resumed. The output after this selection is the speed demand and is summed with negative speed feedback to produce a speed error. This is then processed in the speed loop P + I error amplifier. The output of this block is the current reference that is sent to the current control blocks during normal running. See 6.7 CHANGE PARAMETERS / SPEED CONTROL.

#### 6.6.1 SPEED REF SUMMER / Block diagram

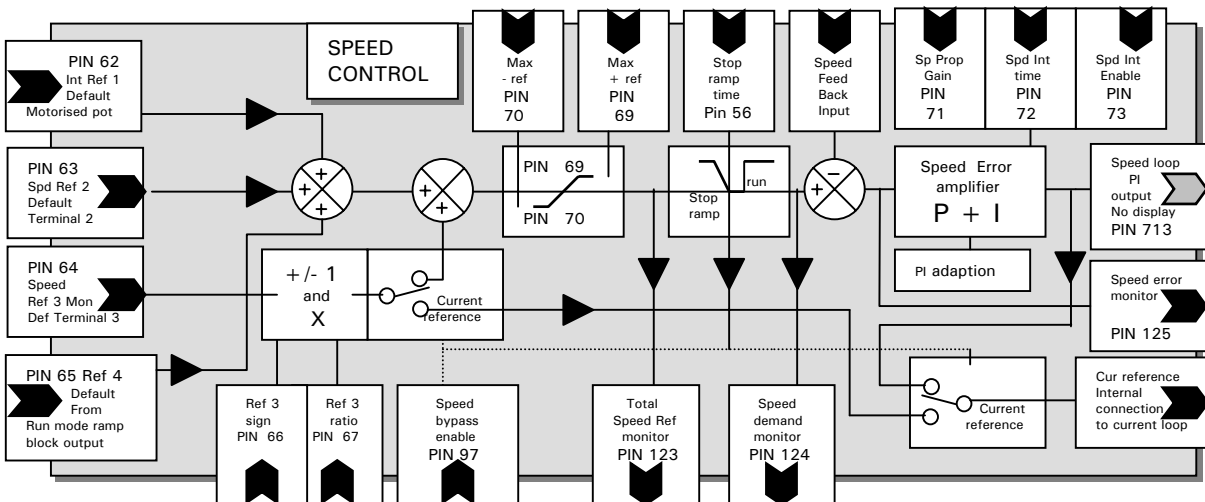

6.6.2 SPEED REF SUMMER / Internal speed reference 1 PIN 62

Diagram showing the connection for parameter 62)INT SPEED REF 1. It features a 'SPEED REF SUMMER' block with parameter 3 and '62)INT SPEED REF 1' set to 0.00%. This is connected to a potentiometer symbol. Below the diagram is a table with columns: PARAMETER, RANGE, DEFAULT, and PIN.

PARAMETER	RANGE	DEFAULT	PIN
INT SPEED REF 1	+/-105.00%	0.00%	62

Sets internal reference 1 level.

Default connection to the motorised potentiometer output.

6.6.3 SPEED REF SUMMER / Auxiliary speed reference 2 PIN 63

Diagram showing the connection for parameter 63)SPEED REF 2. It features a 'SPEED REF SUMMER' block with parameter 3 and '63)SPEED REF 2' set to 0.00%. This is connected to a potentiometer symbol. Below the diagram is a table with columns: PARAMETER, RANGE, DEFAULT, and PIN.

PARAMETER	RANGE	DEFAULT	PIN
SPEED REF 2	+/-105.00%	0.00%	63

Sets aux speed reference 2 level. Default connection to T2.

6.6.4 SPEED REF SUMMER / Speed reference 3 monitor PIN 64

Diagram showing the connection for parameter 64)SPEED REF 3 MON. It features a 'SPEED REF SUMMER' block with parameter 3 and '64)SPEED REF 3 MON' set to 0.00%. This is connected to a potentiometer symbol. Below the diagram is a table with columns: PARAMETER, RANGE, DEFAULT, and PIN.

PARAMETER	RANGE	DEFAULT	PIN
64)SPEED REF 3 MON	+/-105.00%	0.00%	64

Monitors speed ref 3 level  
Permanent connection to T3.

T3 is internally connected via UIP3 to 64)SPEED REF 3 MON, so this behaves as a monitor of T3 IP value. This parameter is not adjustable from the keys. It has the fastest sample rate for rapid response applications. Note. When 97)SPD BYPASS CUR EN is ENABLED this monitor is set to zero. Use 133)ARM CUR DEM MON.

6.6.5 SPEED REF SUMMER / Ramped speed reference 4 PIN 65

Diagram showing the connection for parameter 65)RAMPED SPD REF 4. It features a 'SPEED REF SUMMER' block with parameter 3 and '65)RAMPED SPD REF 4' set to 0.00%. This is connected to a potentiometer symbol. Below the diagram is a table with columns: PARAMETER, RANGE, DEFAULT, and PIN.

PARAMETER	RANGE	DEFAULT	PIN
RAMPED SPD REF 4	+/-105.00%	0.00%	65

Sets speed reference 4 level.  
Default via ramp block from T4

The factory default is to the run mode ramp block output, so this behaves as a monitor for this value.

6.6.6 SPEED REF SUMMER / Speed/Current Reference 3 sign PIN 66

Diagram showing the connection for parameter 66)SPD/CUR REF3 SIGN. It features a 'SPEED REF SUMMER' block with parameter 3 and '66)SPD/CUR REF3 SIGN' set to NON-INVERT. This is connected to a potentiometer symbol. Below the diagram is a table with columns: PARAMETER, RANGE, DEFAULT, and PIN.

PARAMETER	RANGE	DEFAULT	PIN
SPD/CUR REF3 SIGN	INVERT / NON-INVERT	NON-INVERT	66

Inverts the speed/current reference 3.

6.6.7 SPEED REF SUMMER / Speed/Current Reference 3 ratio PIN 67

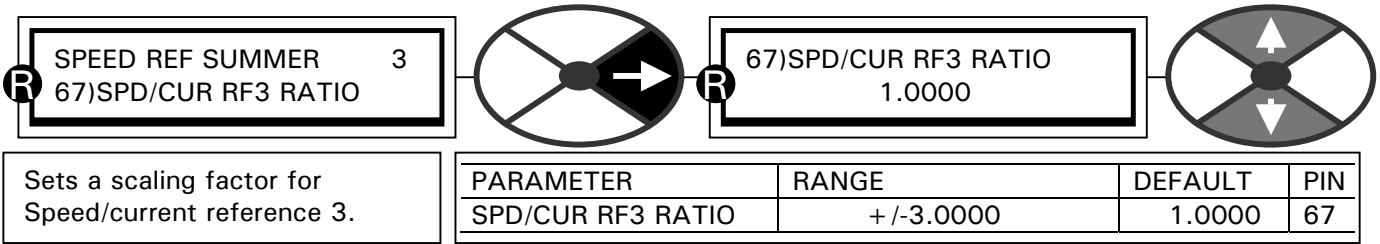

The internal connection from UIP3 to 64)SPEED REF 3 MON is permanent. However 64)SPEED REF 3 MON may be disconnected from the SPEED REF SUMMER by setting 67)SPD/CUR RF3 RATIO to 0.0000.

6.7 CHANGE PARAMETERS / SPEED CONTROL

PIN number range 69 to 79

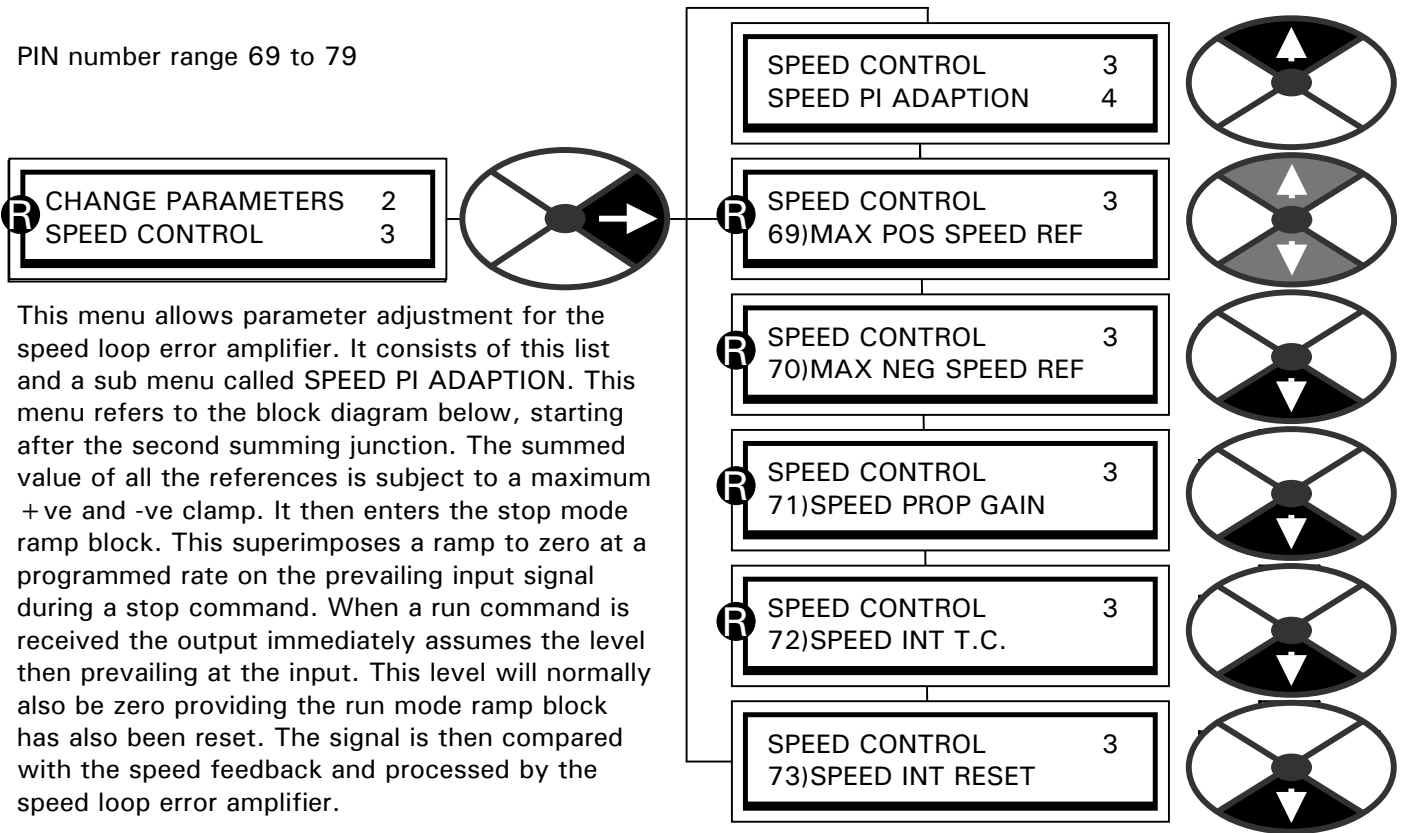

The basic PI gain and time constants are adjustable in this list, and with further sophistication in the sub list SPEED PI ADAPTION. After being output from the error amplifier the signal now represents current reference. This current reference signal is then selected for output by the speed bypass change over switch. If the speed bypass mode is enabled then input reference 3 is selected.

Note. The default values in this menu have been chosen to suit tacho or encoder feedback. AVF feedback usually contains more ripple than tacho or encoder feedback, hence it is advisable to reduce the SPEED CONTROL loop gains whenever AVF or ENCODER + ARM VOLTS feedback is selected. See 6.7.4 SPEED CONTROL / Speed proportional gain PIN 71.

In the case of AVF, it is suggested that the values for the following parameters are changed as follows.

6.7.4 SPEED CONTROL / Speed proportional gain PIN 71 set to 7.00.

6.7.7.6 SPEED PI ADAPTION / Speed loop adaption enable PIN 79 set to DISABLED.

These are suggested starting points for smooth responsive control, however it may be possible to make improvements with further experimentation.

6.7.1 SPEED CONTROL / Block diagram

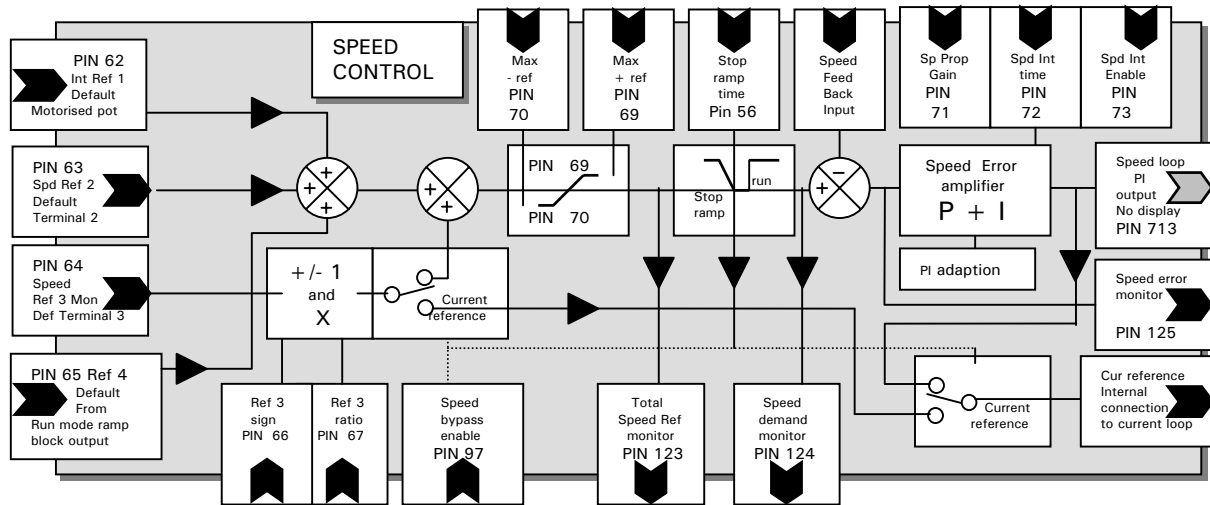

6.7.2 SPEED CONTROL / Max positive speed reference PIN 69

R

SPEED CONTROL 3  
 69)MAX POS SPEED REF

→

R

69)MAX POS SPEED REF  
 + 105.00%

Sets positive (forward) limit level of total speed reference.

PARAMETER	RANGE	DEFAULT	PIN
MAX POS SPEED REF	0.00 to + 105.00%	105.00%	69

6.7.3 SPEED CONTROL / Max negative speed reference PIN 70

R

SPEED CONTROL 3  
 70)MAX NEG SPEED REF

→

R

70)MAX NEG SPEED REF  
 -105.00%

Sets negative (reverse) limit level of total speed reference.

PARAMETER	RANGE	DEFAULT	PIN
MAX NEG SPEED REF	0.00 to -105.00%	-105.00%	70

6.7.4 SPEED CONTROL / Speed proportional gain PIN 71

R

SPEED CONTROL 3  
 71)SPEED PROP GAIN

→

R

71)SPEED PROP GAIN  
 15.00

Sets the proportional gain of the speed loop error amplifier.

PARAMETER	RANGE	DEFAULT	PIN
SPEED PROP GAIN	0.00 to 200.00	15.00	71

Increase to improve response time, excessive values may cause instability.

6.7.5 SPEED CONTROL / Speed integral time constant PIN 72

**R** SPEED CONTROL 3  
72)SPEED INT T.C.

**R** 72)SPEED INT T.C.  
1.000 SECS

Sets the integral time constant of the speed loop error amplifier.	PARAMETER	RANGE	DEFAULT	PIN
	SPEED INT T.C.	0.001 to 30.000 secs	1.000 secs	72

This should be matched with the mechanical time constant of the motor/load combination. Generally an increased integral time will slow the response.

6.7.6 SPEED CONTROL / Speed integral reset enable PIN 73

SPEED CONTROL 3  
73)SPEED INT RESET

73)SPEED INT RESET  
DISABLED

The integral reset can be enabled leaving prop only.	PARAMETER	RANGE	DEFAULT	PIN
	SPEED INT RESET	ENABLED OR DISABLED	DISABLED	73

6.7.7 SPEED CONTROL / SPEED PI ADAPTION

This menu allows sophisticated modification of the speed loop error amplifier. It can provide modified gains of the proportional and integral terms with the gains changing linearly as the

SPEED CONTROL 3  
SPEED PI ADAPTION 4

SPEED PI ADAPTION 4  
79)SPD ADAPT ENABLE

SPEED PI ADAPTION 4  
74)SPD ADPT LO BRPNT

SPEED PI ADAPTION 4  
75)SPD ADPT HI BRPNT

SPEED PI ADAPTION 4  
76)LO BRPNT PRP GAIN

SPEED PI ADAPTION 4  
77)LO BRPNT INT T.C.

SPEED PI ADAPTION 4  
78)INT % DURING RAMP

speed error signal moves between 2 break points.

79)SPD ADAPT ENABLE is used to activate the function. The low break point is the starting level for gain changing and the high break point is the finishing level. Below the low break point the terms are set by 76)LOW BRPNT PRP GAIN and 77)LOW BRPNT INT T.C. in this sub-menu.

Above the high break point the terms are set by 71)SPEED PROP GAIN and 72)SPEED INT T.C. in the previous menu.

The change is linear between the 2 sets of terms as the actuating signal (speed error) traverses between the chosen break points. The break points work symmetrically for each polarity of error.

There is also the ability to prevent the integrator from accumulating error during a long speed up ramp. This can be useful for systems involving high inertias where there is a possibility of speed error at the top of the ramp while the loop removes the integrator error. See 6.2.16 RUN MODE RAMPS / Ramping flag PIN 35. See 6.7.7.7 SPEED PI ADAPTION / Using small speed inputs. The default gives low gain for small inputs.

6.7.7.1 SPEED PI ADAPTION / Low break point PIN 74

SPEED PI ADAPTION 4  
74)SPD ADPT LO BRPNT

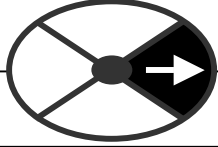

74)SPD ADPT LO BRPNT  
1.00%

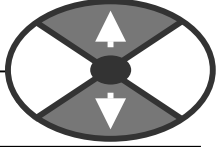

Sets the low break point for commencement of gain change

PARAMETER	RANGE	DEFAULT	PIN
SPD ADPT LO BRPNT	0.00 to 100.00%	1.00%	74

6.7.7.2 SPEED PI ADAPTION / High break point PIN 75

SPEED PI ADAPTION 4  
75)SPD ADPT HI BRPNT

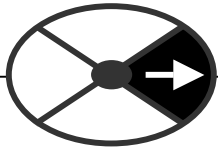

75)SPD ADPT HI BRPNT  
2.00%

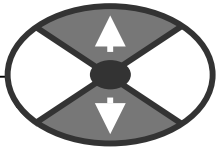

Sets the high break point for end of linear gain change

PARAMETER	RANGE	DEFAULT	PIN
SPD ADPT HI BRPNT	0.00 to 100.00%	2.00%	75

6.7.7.3 SPEED PI ADAPTION / Low breakpoint proportional gain PIN 76

SPEED PI ADAPTION 4  
76)LO BRPNT PRP GAIN

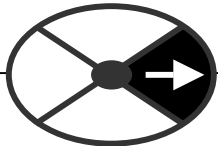

76)LO BRPNT PRP GAIN  
5.00

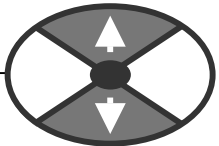

Sets the prop gain of the error amp below the low break point.

PARAMETER	RANGE	DEFAULT	PIN
LO BRPNT PRP GAIN	0.00 to 200.00	5.00	76

6.7.7.4 SPEED PI ADAPTION / Low breakpoint integral time constant PIN 77

SPEED PI ADAPTION 4  
77)LO BRPNT INT T.C.

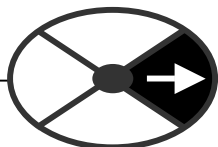

77)LO BRPNT INT T.C.  
1.000 SECS

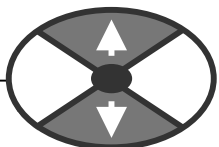

Sets the integral time constant below the low break point.

PARAMETER	RANGE	DEFAULT	PIN
LO BRPNT INT T.C.	0.001 to 30.000 secs	1.000 secs	77

6.7.7.5 SPEED PI ADAPTION / Integral % during ramp PIN 78

SPEED PI ADAPTION 4  
78)INT % DURING RAMP

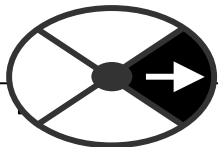

78)INT % DURING RAMP  
100.00%

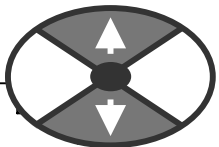

Sets integral time constant % scaler if RAMPING flag is high

PARAMETER	RANGE	DEFAULT	PIN
INT % DURING RAMP	0.00 to 100.00%	100.00%	78

See 6.2.16 RUN MODE RAMPS / Ramping flag PIN 35.

Note, a level of 100% results in the integrator being un-affected by 35)RAMPING FLAG.

See also 6.2.16 RUN MODE RAMPS / Ramping flag PIN 35 and 6.5.1.4 Precise stopping.

6.7.7.6 SPEED PI ADAPTION / Speed loop adaption enable PIN 79

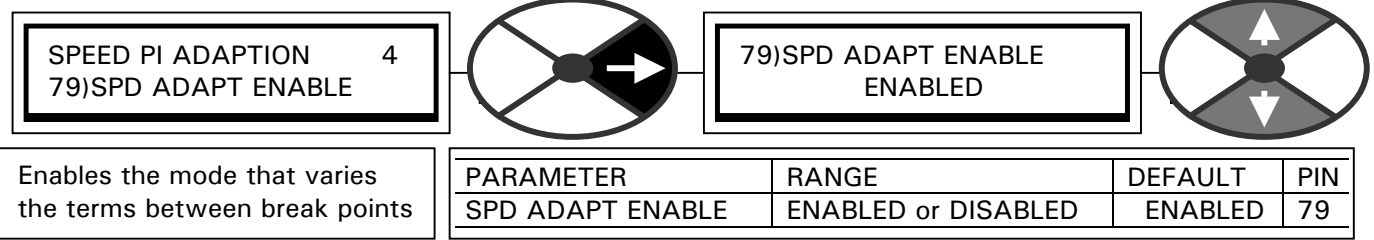

The X-axis internal connection is the speed error signal.

The default values in this SPEED PI ADAPTION sub-menu are chosen as a starting point.

The most frequently encountered requirement is for the gain term of the speed loop error amplifier to be high for large speed errors, and low for small errors.

When the function is enabled the default values of prop gain are 5 for errors below 1.00%, and 15 for errors above 2.00% with a linear change from 5 to 15 between 1.00% and 2.00%.

A decreasing gain with error is also possible by choosing appropriate term values in this and the upper SPEED CONTROL menus.

Graph of adaption profile for **default values**.

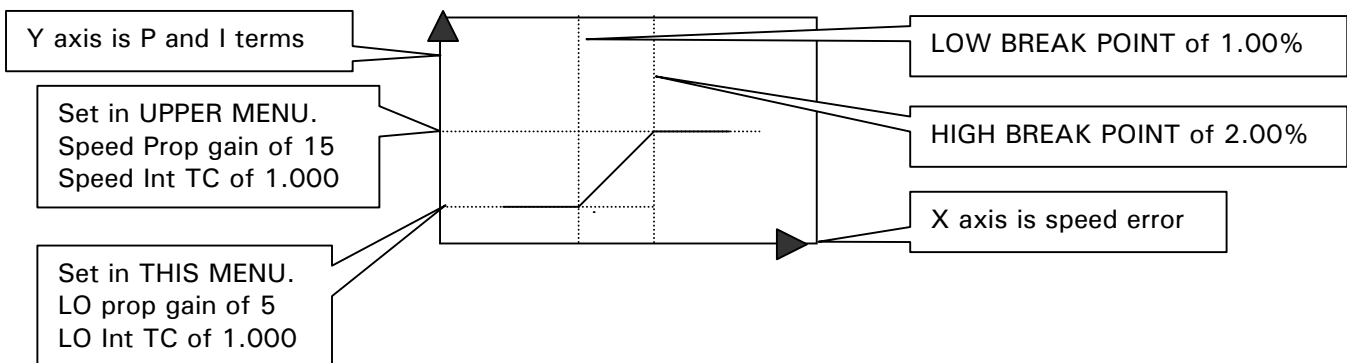

**Note.** The default settings are designed to give lower gain with low error. This provides smooth steady state performance. Applications that require precise control at very low speeds may function better with the adaption disabled.

See also 6.10.8.1 Low speed performance

6.7.7.7 SPEED PI ADAPTION / Using small speed inputs

Some applications utilise very small speed inputs e. g. positioning. In this case the default settings for the SPEED PI ADAPTION may be unsuitable. This is because they are designed to give low gain for low errors which provides smooth running at speed.

For small inputs it may be necessary to either DISABLE the function, or modify the parameters to provide higher gain for small errors. See 6.10.8.1 Low speed performance.



### 6.8 CHANGE PARAMETERS / CURRENT CONTROL

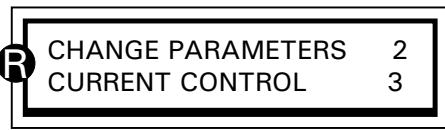

PIN number range 81 to 97.  
 The current control menu looks fairly complex initially, but is not too difficult to understand when considered in separate blocks.  
 See 6.8.1 CURRENT CONTROL / Block diagram.  
 The current control loop gets its current reference from the output of the speed loop error amplifier. The reference enters the current control section and is subjected to a series of 4 clamps.

i3)CURRENT LIMIT(%). This provides the absolute limits of overload. (See CALIBRATION menu).

ii) CURRENT OVERLOAD. This allows the drive to actively modify the current overload as it occurs. The reduction rate of the overload is adjustable. After an overload, the load must return below the target level for an equivalent time, to re-enable the overload capability.

iii) I DYNAMIC PROFILE. This clamp is used to protect motor commutators that have problems commutating current at high speed or in field weakening mode of operation. This function allows the setting of break points that profile the current according to the speed.

iv) 89)UPPER CUR CLAMP and 90)LOWER CUR CLAMP. These clamps allow the current limits to be adjusted from external signals. They can accept a single positive input and produce a scaled bipolar clamp, or separate positive and negative inputs for the upper clamp and lower clamp. Scaling is achieved by a master current scaler.

**The 4 clamps operate such that the lowest has priority.** The actual prevailing clamp level is available as a diagnostic for +ve and -ve current.

The output of the clamping stage is referred to as the current demand, and is compared with the current feedback in a P + I error amplifier. The control terms and a non-linear adaptive algorithm are available for programming. There is also the facility to activate a super fast current response. See 13.13.3 DRIVE PERSONALITY / Maximum current response PIN 678.

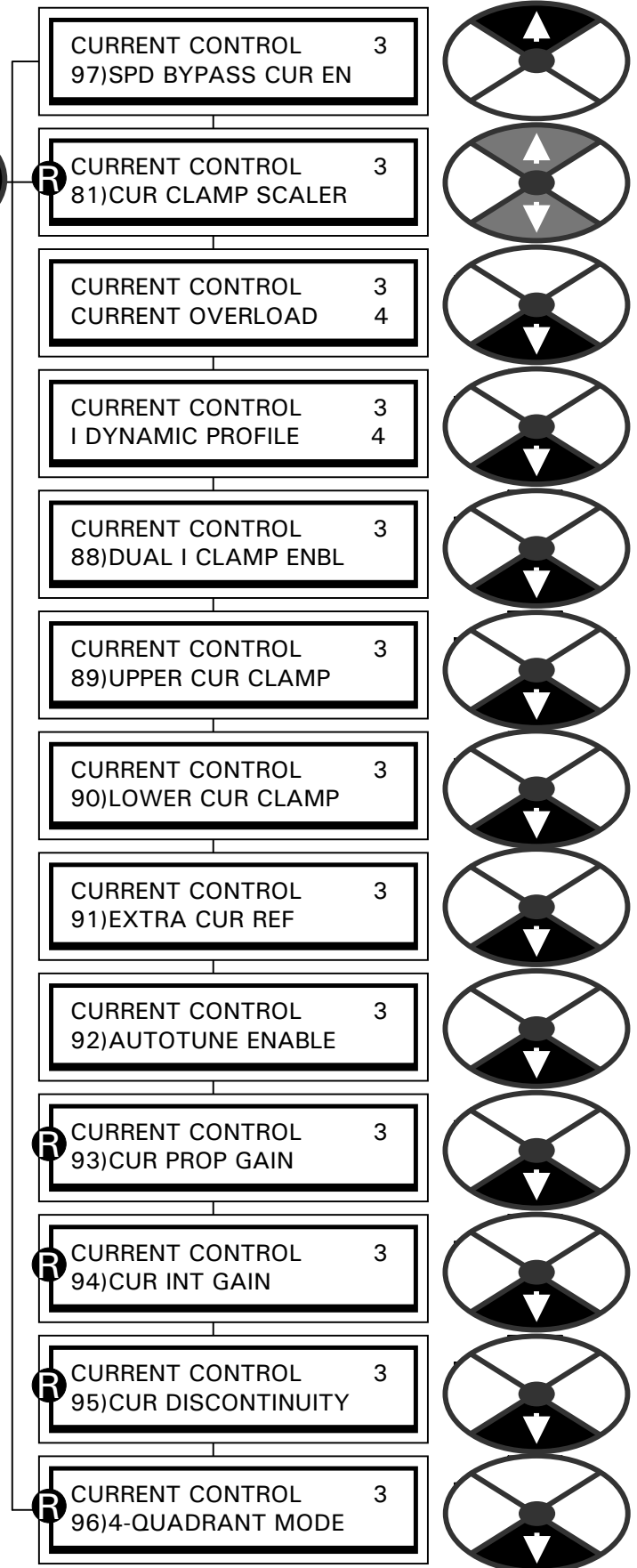

The output becomes the phase angle demand for the thyristor stack.

6.8.1 CURRENT CONTROL / Block diagram

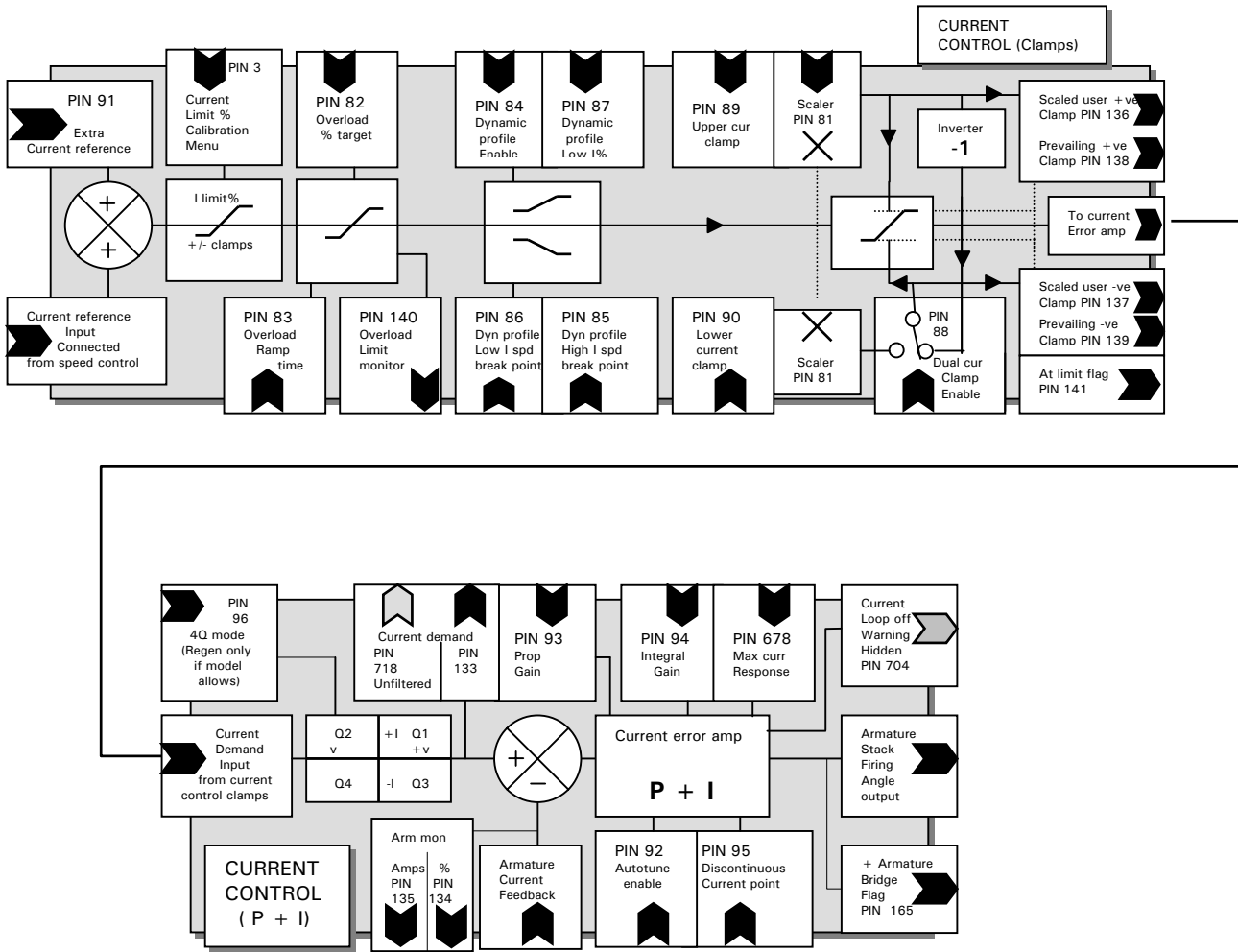

6.8.2 CURRENT CONTROL / Current clamp scaler PIN 81

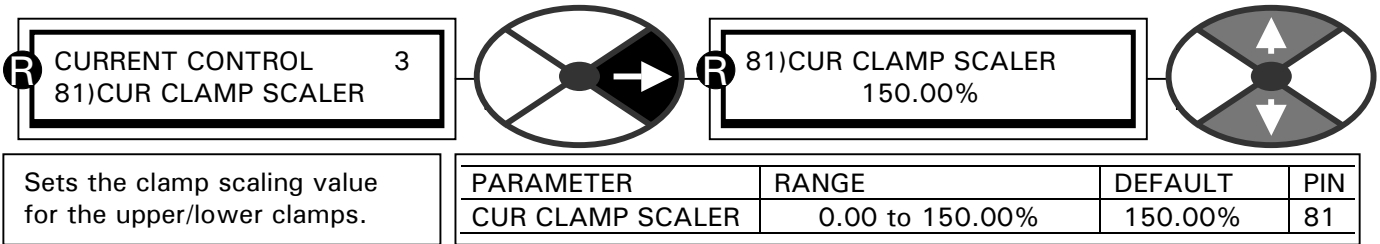

6.8.3 CURRENT CONTROL / CURRENT OVERLOAD

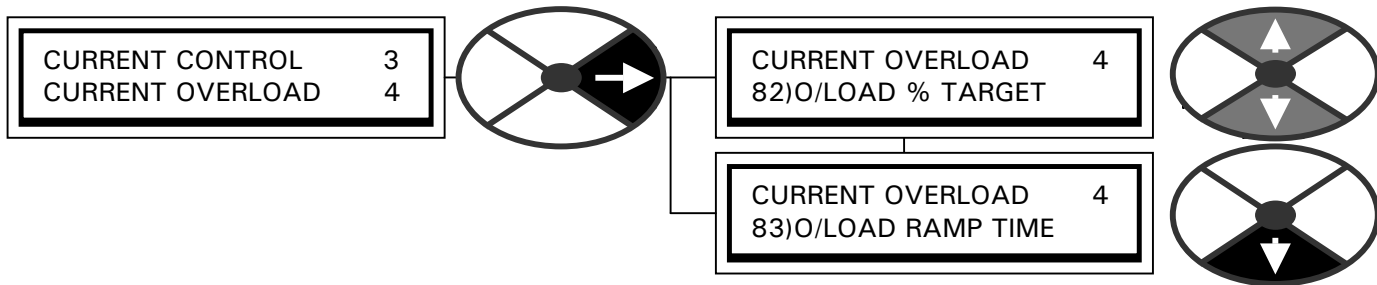

6.8.3.1 CURRENT OVERLOAD / Overload % target PIN 82

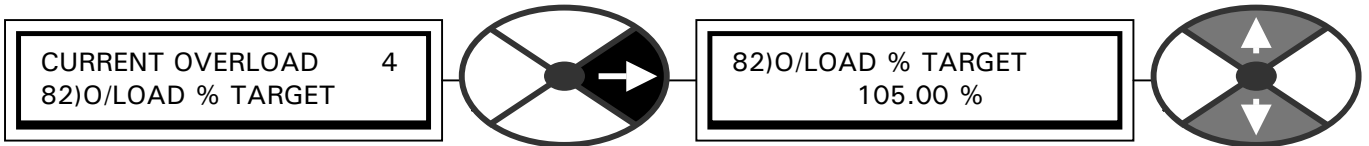

Sets the current limit target level after excessive overload.

PARAMETER	RANGE	DEFAULT	PIN
O/LOAD % TARGET	0.00 TO 105.00 %	105.00%	82

This CURRENT OVERLOAD menu allows the final current % target **limit** to be set by this parameter.

**This would normally be the full load current of the motor.**

Having the facility to set this parameter independantly of 2)RATED ARM AMPS allows further flexibility.

This block allows the load current to span up to 150% of 2)RATED ARM AMPS. (If any other lower limits are prevailing they will of course determine the current limit). See 6.8.1 CURRENT CONTROL / Block diagram.

An internal integrator, with a finite capacity, fills up when the armature current exceeds **PIN 82**, it empties for armature current less than **PIN 82**. The unused capacity of the integrator determines the time remaining, before automatic reduction of the current limit commences. A 150% limit is available until the integrator becomes full. Then the current limit is linearly reduced **in this block** from 150% towards **PIN 82**.

Note. The limit reduction always starts from 150% and ramps down towards 82)O/LOAD % TARGET.

See 6.8.3.2 CURRENT OVERLOAD / Overload ramp time PIN 83.

If the load continues to require current in excess of **PIN 82 level** then it will remain limited to **PIN 82 level**. (NOTE this implies the speed loop is not getting the current it demands and hence there will be speed error).

If the load subsequently falls beneath **PIN 82 level**, then the internal integrator starts to de-integrate back to its empty state. (Ready for next overload). The overload available will start increasing.

**However full de-integration is required before the full overload capacity is once more available.**

Note. For small overloads the time prior to limit reduction can be very long, but the integrator is still filling up. Hence after a long small overload, any excursion to the 150% limit will very quickly precipitate a reduction.

6.8.3.1.1 Diagram showing O/LOAD % TARGET set to 105%

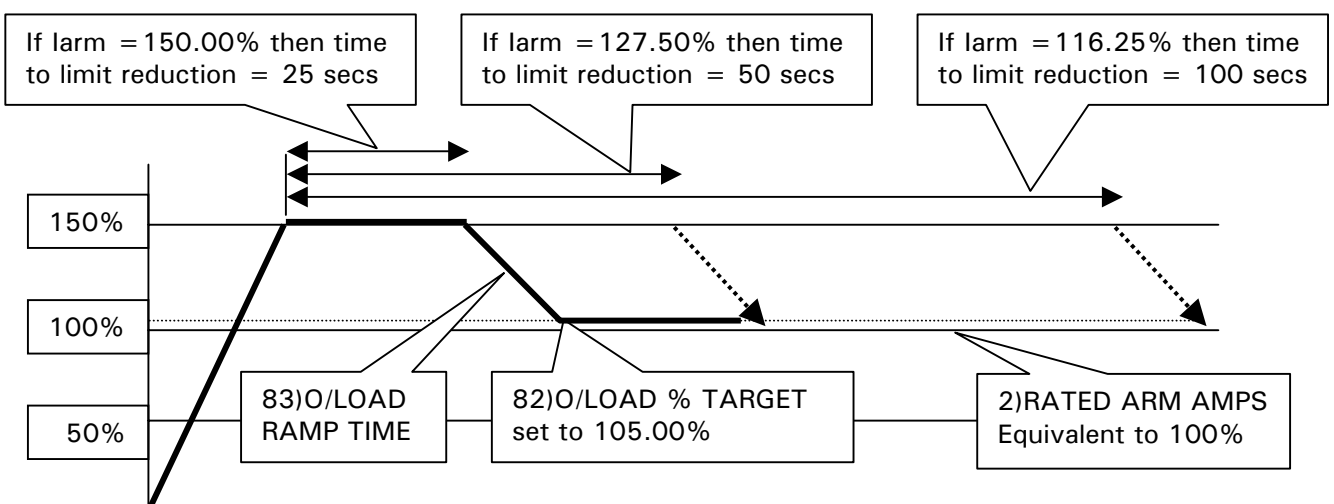

Target level = 105%, current = 150.00%, hence overload of 45.00% gives 25 secs prior to limit reduction.  
 Target level = 105%, current = 127.50%, hence overload of 22.50% gives 50 secs prior to limit reduction.  
 Target level = 105%, current = 109.50%, hence overload of 4.50% gives 250 secs prior to limit reduction.

The time prior to overload limit reduction is a dynamic property proportional to the unused capacity of the integrator. The rate of **integration / de-integration** is proportional to the current level **above / below PIN 82**.

For **PIN 82 < 105%**, the integrator capacity automatically adjusts to give 25 secs at Iarm = 150%.

6.8.3.1.2 How to get overloads greater than 150% using 82)O/LOAD % TARGET

Use this to provide larger overload percentages on motors smaller than the PL/X model rating. This example shows how 82)O/LOAD % TARGET provides a 200% overload for a 9 amp motor with a 12 amp PL/X5.

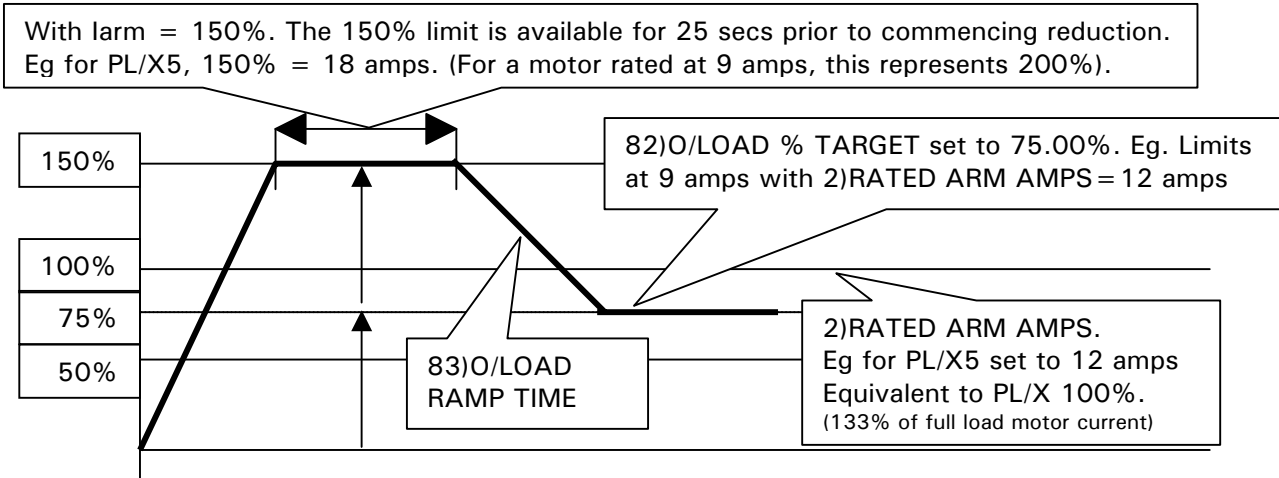

- 1) The current set on 2)RATED ARM AMPS (12 amps) represents 100% of the drive (PL/X5), but for this application must be deliberately set higher than the normal full load motor current (9 amps).
  - 2) The parameter 82)O/LOAD % TARGET is set at a level **equivalent to the normal full load motor current**. (9 amps). Here this is equivalent to 75% of 2)RATED ARM AMPS (12 amps).
  - 3) The 150% limit (18 amps) is now double the 82)O/LOAD % TARGET (75%), which represents a 200% overload capability with respect to the full load motor current. (9 amps).
- AUTOTUNE with 2)RATED ARM AMPS = 12A. See 6.8.9 CURRENT CONTROL / Autotune enable PIN 92.  
**Set 8.1.8.2 STALL TRIP MENU / Stall current level PIN 179, to a value less than 82)O/LOAD % TARGET.**

6.8.3.1.3 Maximum overload table

Table showing maximum overloads according to:- Full load motor current, as a % of 2)RATED ARM AMPS.

Full load motor current (82)O/LOAD % TARGET) as a % of 2)RATED ARM AMPS	Maximum available	Maximum overload % available. (With respect to full load motor current)
100%	150%	150 / 100 = 150%
90%	150%	150 / 90 = 166%
80%	150%	150 / 80 = 187%
75%	150%	150 / 75 = 200%
60%	150%	150 / 60 = 250%
50%	150%	150 / 50 = 300%
37.5%	150%	150 / 37.5 = 400%
30%	150%	150 / 30 = 500%

There are 2 overcurrent trip mechanisms.

- 1) A software threshold which is set at 300% of 2)RATED ARM AMPS.
  - 2) A hardware threshold which activates in excess of 150% of the maximum PL/X model rating. AUTOTUNE with 2)RATED ARM AMPS set to its final value. See example above for 9 amp motor.  
**Set 8.1.8.2 STALL TRIP MENU / Stall current level PIN 179, to a value less than 82)O/LOAD % TARGET.**
- If 3)CURRENT LIMIT(%) or 82)O/LOAD % TARGET level is set to 0%, then no current will flow.

6.8.3.2 CURRENT OVERLOAD / Overload ramp time PIN 83

CURRENT OVERLOAD 4  
83)O/LOAD RAMP TIME

83)O/LOAD RAMP TIME  
20.0 SECS

PARAMETER	RANGE	DEFAULT	PIN
O/LOAD RAMP TIME	0.1 to 20.0 secs	20.0secs	83

Sets the time taken to reduce the current limit by 100%

E.g. For Limit = 150%, time = 20 secs, target = 105%. Then ramp time to target = 9 secs (ie.45% of 20 secs).

6.8.4 CURRENT CONTROL / I DYNAMIC PROFILE

This function works for both directions of rotation.

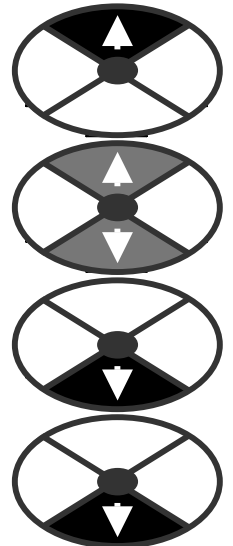
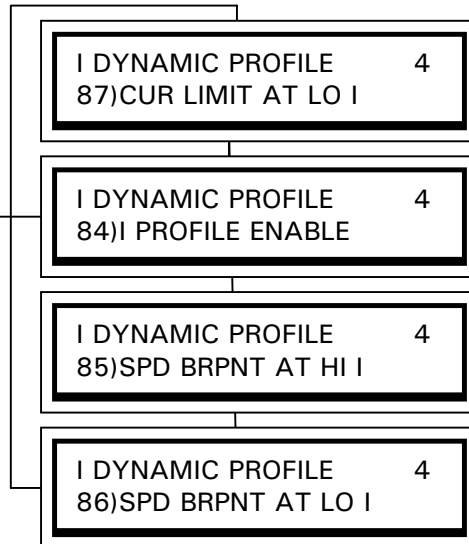
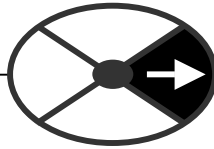

I DYNAMIC PROFILE. This clamp is used to change the current limit according to speed. E.g.

- 1) To protect motors that have problems commutating current at high speeds in field weakening mode of operation.
- 2) To prevent motors overheating at low speeds.

An upper current limit of fixed value 150% is used in the calculation. If 3)CURRENT LIMIT(%) is set lower than 150%, then 3)CURRENT LIMIT(%) will prevail. If current limits in the other current limit blocks are lower then they will prevail.

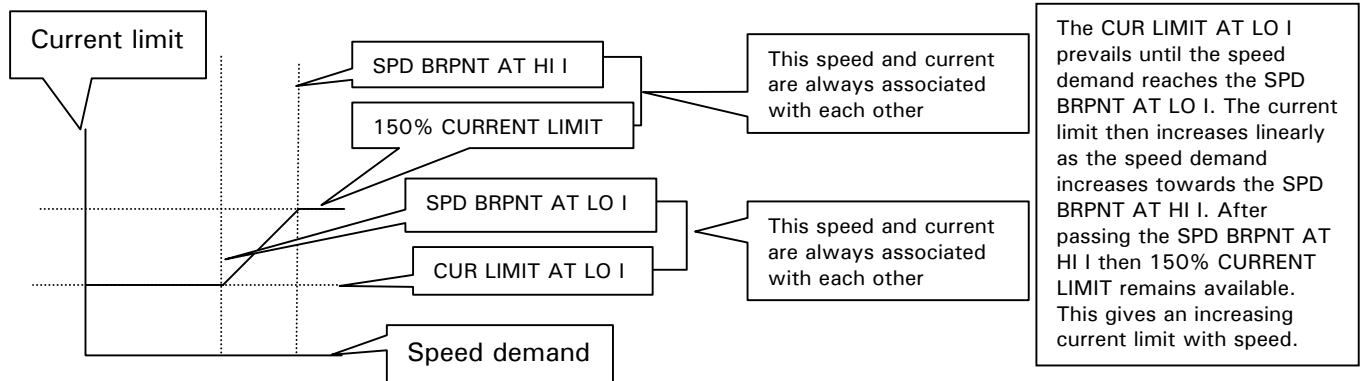
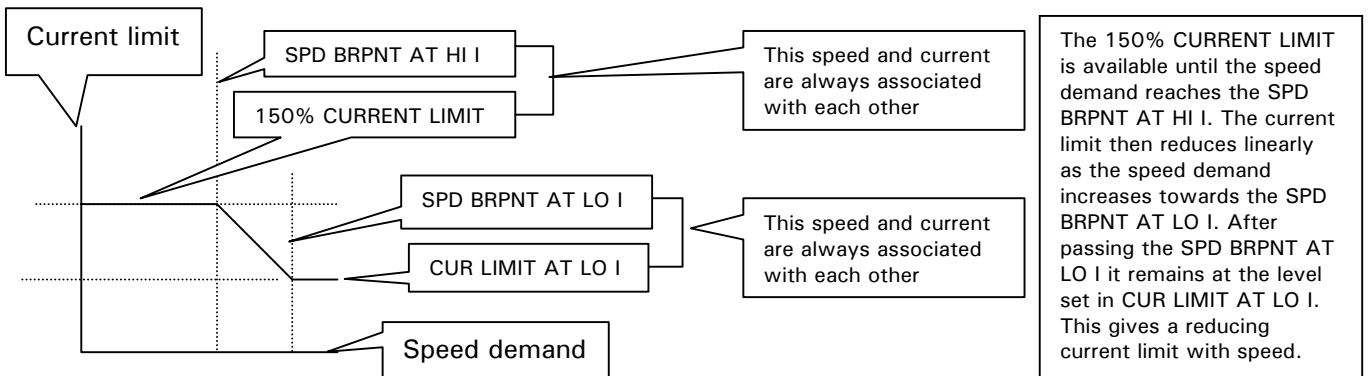

Note. The SPEED breakpoints may be set so that the profile starts low and goes high if required. If you try to bring the two speed breakpoints closer than within 10% of each other, then the higher speed breakpoint is internally assumed to be equal to the lower speed breakpoint + 10%.

6.8.4.1 I DYNAMIC PROFILE / Profile enable PIN 84

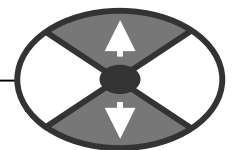
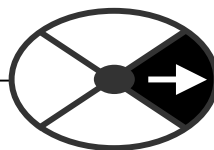

Enables or disables the dynamic profile function.

PARAMETER	RANGE	DEFAULT	PIN
PROFILE ENABLE	ENABLED OR DISABLED	DISABLED	84

6.8.4.2 I DYNAMIC PROFILE / Speed break point for high current limit PIN 85

I DYNAMIC PROFILE 4  
85)SPD BRPNT AT HI I

85)SPD BRPNT AT HI I  
75.00%

Sets the speed break point for 150% CURRENT LIMIT.

PARAMETER	RANGE	DEFAULT	PIN
SPD BRPNT AT HI I	0.00 to 105.00%	75.00%	85

Note. 3)CURRENT LIMIT(%) set in the CALIBRATION menu will prevail. This is the normal current limit setting. However the profile **calculation** starts or ends at 150%.

6.8.4.3 I DYNAMIC PROFILE / Speed break point for low current limit PIN 86

I DYNAMIC PROFILE 4  
86)SPD BRPNT AT LO I

86)SPD BRPNT AT LO I  
100.00%

Sets the speed break point for 87)CUR LIMIT AT LO I

PARAMETER	RANGE	DEFAULT	PIN
SPD BRPNT AT LO I	0.00 to 105.00%	100.00%	86

6.8.4.4 I DYNAMIC PROFILE / Profile current for low current limit PIN 87

I DYNAMIC PROFILE 4  
87)CUR LIMIT AT LO I

87)CUR LIMIT AT LO I  
100.00%

Sets the current limit prevailing at 86)SPEED BRPNT AT LO I

PARAMETER	RANGE	DEFAULT	PIN
CUR LIMIT AT LO I	0.00 to 150.00%	100.00%	87

6.8.5 CURRENT CONTROL / Dual current clamps enable PIN 88

CURRENT CONTROL 3  
88)DUAL I CLAMP ENBL

88)DUAL I CLAMP ENBL  
DISABLED

Enables the upper and lower dual clamps to be independant

PARAMETER	RANGE	DEFAULT	PIN
DUAL I CLAMP ENBL	ENABLED OR DISABLED	DISABLED	88

If 88)DUAL I CLAMP ENBL is disabled then the clamps produce symmetric +ve and -ve current limits in conjunction with 81)CUR CLAMP SCALER. The default control terminal is T6. If 88)DUAL I CLAMP ENBL (default terminal T21) is enabled then the upper input is default T6 and the lower input is default T5. Each clamp can work in each polarity provided the upper is algebraically above the lower

However: If the upper clamp is set negative and the lower clamp set positive than the result is 0.00%.

If the lower clamp is more positive than the upper clamp in the positive region the upper clamp behaves as a current demand.

If the upper clamp is more negative than the lower clamp in the negative region the lower clamp behaves as a current demand.

6.8.6 CURRENT CONTROL / Upper current clamp PIN 89

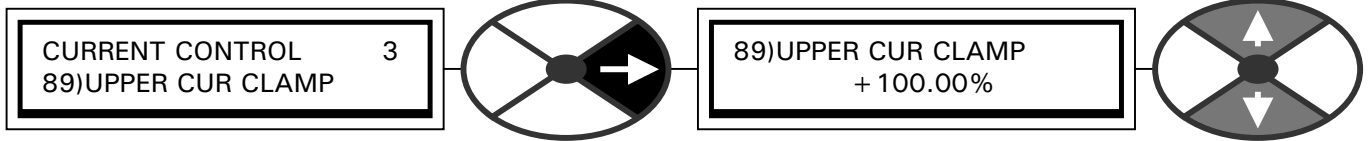

Modifies the upper current limit %.

PARAMETER	RANGE	DEFAULT	PIN
UPPER CUR CLAMP	+/-100.00%	+100.00%	89

The product of this parameter and 81)CUR CLAMP SCALER sets the limit.  
 If the upper clamp is set negative and the lower clamp set positive than the result is 0.00%.  
 If the lower clamp is more +ve than the upper in the +ve region, the upper behaves as a current demand.

6.8.7 CURRENT CONTROL / Lower current clamp PIN 90

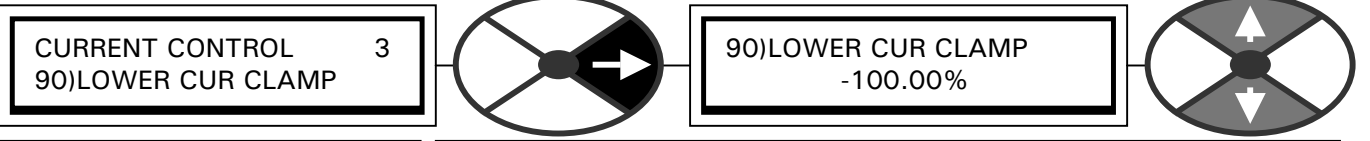

Modifies the lower current limit %.

PARAMETER	RANGE	DEFAULT	PIN
LOWER CUR CLAMP	+/-100.00%	-100.00%	90

The product of this parameter and 81)CUR CLAMP SCALER sets the limit.  
 If the upper clamp is set negative and the lower clamp set positive than the result is 0.00%.  
 If the upper clamp is more -ve than the lower in the -ve region, the lower behaves as a current demand.

6.8.8 CURRENT CONTROL / Extra current reference PIN 91

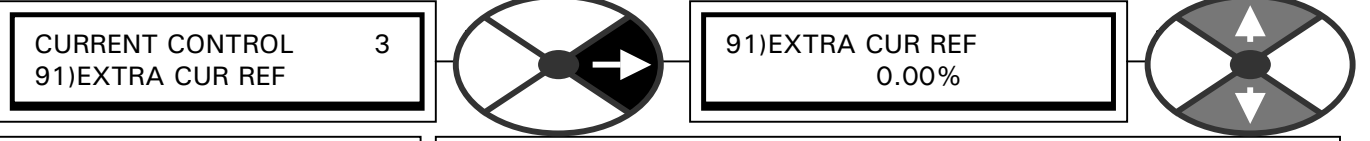

Sets the value of an extra current reference input.

PARAMETER	RANGE	DEFAULT	PIN
EXTRA CUR REF	+/-300.00%	0.00%	91

6.8.9 CURRENT CONTROL / Autotune enable PIN 92

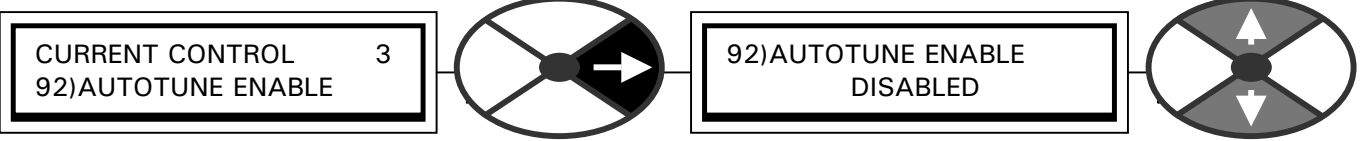

Enables the autotune function to start. It turns itself off.

PARAMETER	RANGE	DEFAULT	PIN
AUTOTUNE ENABLE	ENABLED OR DISABLED	DISABLED	92

**If you change your supply voltage, current calibration or motor type then AUTOTUNE must be repeated.**  
 This is a stationary test. There is no need to disconnect the motor from the load. The motor field is automatically disabled. If the motor rotates above 20% speed due to residual magnetism, the test is aborted.  
 See 8.1.11.16 DRIVE TRIP MESSAGE / Cannot autotune, 8.1.11.17 DRIVE TRIP MESSAGE / Autotune quit.

Note. The autotune function makes a one off adjustment to the current loop error amplifier terms to achieve optimum performance. When ENABLED it will wait until the main contactor is energised and the drive run before starting its autotune routine. **It may take from a few seconds up to about 1 minute typically.**  
 Warning. If the maximum motor armature current rating is less than approximately 50% of the maximum model rating, the AUTOTUNE results may not be optimum. There are 2 possible ways of overcoming this.

Either 1) Set the current loop control terms manually. See 6.8.12 CURRENT CONTROL / Discontinuous current point PIN 95.

Or 2) Re-burden the unit using the 50%/100% burden jumper on the power board. See 13.13.4 DRIVE PERSONALITY / Armature current burden resistance PIN 680.

There are 2 stages to the autotune function.

- Stage 1. The current automatically increases positively until it becomes continuous.
- Stage 2. The current is automatically perturbed until the response is optimised.

When it has finished it drops out the main contactor, sets the required parameters, and then automatically DISABLES itself. You can check that it has finished by looking in the display window and waiting for the DISABLED comment to re-appear on the bottom line. You must then save the parameters using the PARAMETER SAVE menu.

If the routine is interrupted by a power loss or alarm then the routine is aborted and the old parameter values are left intact.

In the case where the motor has a short time constant, the armature current may remain discontinuous, even at currents in excess of 100%. There are 2 possible outcomes.

1) The autotune will find that the current never goes continuous up to 150% in stage 1. Stage 2 is abandoned. The autotune automatically sets the following parameters.  
 93)CUR PROP GAIN is set to 1.00. 94)CUR INT GAIN is set to 7.00.  
 95)CURRENT DISCONTINUITY is set to 0.00%.

2) The autotune will find that the current goes continuous at a high level in stage 1. During stage 2 the induced perturbations cause a current overload to occur. Then the routine is aborted and the old parameter values are left intact. In this case it is suggested that the following parameters are set manually:  
 93)CUR PROP GAIN is set to 1.00. 94)CUR INT GAIN is set to 7.00.  
 95)CURRENT DISCONTINUITY is set to 0.00%.

This is a good starting point although the current loop response may be slow when the armature current is high, (above the discontinuous current point).

Note. There is a hidden PIN which contains 707)AUTOTUNE MONITOR flag (High for start).

6.8.10 CURRENT CONTROL / Current amp proportional gain PIN 93

**CURRENT CONTROL** 3  
93)CUR PROP GAIN

93)CUR PROP GAIN  
30.00

Sets the proportional gain of the current error amplifier.

PARAMETER	RANGE	DEFAULT	PIN
CUR PROP GAIN	0.00 to 200.00	30.00	93

**This can be set by using the AUTOTUNE function.** Increase to improve response, too much may cause instability. **If you change your supply voltage, current calibration or motor type then re-adjust this parameter.**

6.8.11 CURRENT CONTROL / Current amp integral gain PIN 94

**CURRENT CONTROL** 3  
94)CUR INT GAIN

94)CUR INT GAIN  
3.00

Sets the integral gain of the current error amplifier.

PARAMETER	RANGE	DEFAULT	PIN
CUR INT GAIN	0.00 to 200.00	3.00	94

**This can be set by using the AUTOTUNE function.** Generally an increased integral gain will improve the response. **If you change your supply voltage, current calibration or motor type then re-adjust this parameter.**



6.8.12 CURRENT CONTROL / Discontinuous current point PIN 95

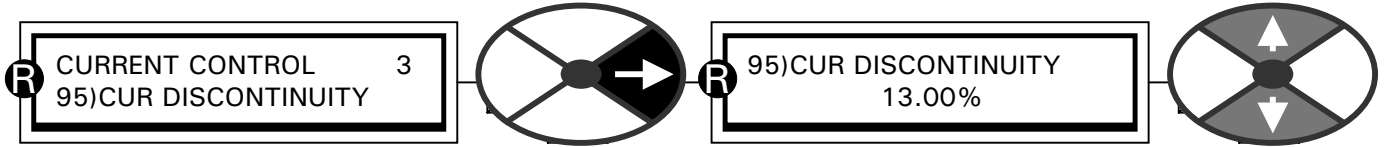

Set to the discontinuous current boundary level for your motor.	PARAMETER	RANGE	DEFAULT	PIN
	CUR DISCONTINUITY	0.00 to 200.00%	13.00%	95

**This can be set by using the AUTOTUNE function.** The motor/supply combination will possess a property called the discontinuous-continuous current point which is important for optimum tuning of the current loop. **If you change your supply voltage, current calibration or motor type then re-adjust this parameter.**

6.8.12.1 Setting the current loop control terms manually.

As the current increases there comes a point when the current stops appearing in 6 discrete lumps per cycle and just starts going continuous. At this point the natural gain of the system changes dramatically. If the unit knows this point, it can automatically compensate for the gain change and produce an optimum response. The current level % of rated motor current at which it occurs is entered here. **If you change your supply voltage, current calibration or motor type, the 3 values for PINs 93/94/95 must be adjusted accordingly.** To observe the current signal you must use the signal test pin provided, and a quality storage oscilloscope. See 3.4.5 Signal test pins. Monitor 134)ARM CUR % MON to monitor the % value at the boundary.

Use the table to determine the other current loop control terms

134)ARM CUR % MON at boundary point	Suggested value for 93)CUR PROP GAIN	Suggested value for 94)CUR INT GAIN
10.00%	40.00	4.00
20.00%	20.00	2.00
40.00%	10.00	1.00
60.00%	10.00	1.00
80.00%	10.00	1.00
100.00%	10.00	1.00

6.8.13 CURRENT CONTROL / 4 quadrant mode enable PIN 96

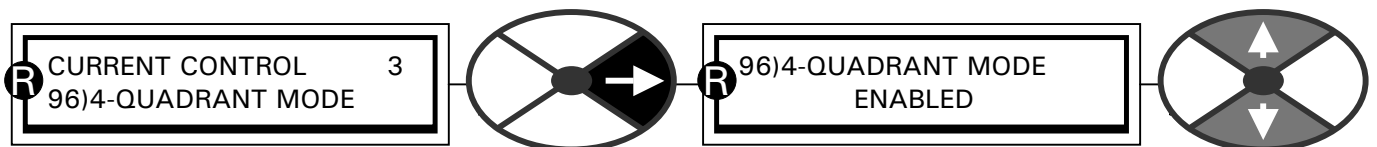

Allows models with regenerative capability to be 2 quadrant.	PARAMETER	RANGE	DEFAULT	PIN
	4-QUADRANT MODE	ENABLED or DISABLED	ENABLED	96

If 96)4-QUADRANT MODE is enabled then the regenerative capability will be determined by the model. See 3.3 General Technical Data. Note. PL models with regenerative stopping. This feature is also dis/enabled.

6.8.14 CURRENT CONTROL / Speed bypass current reference enable PIN 97

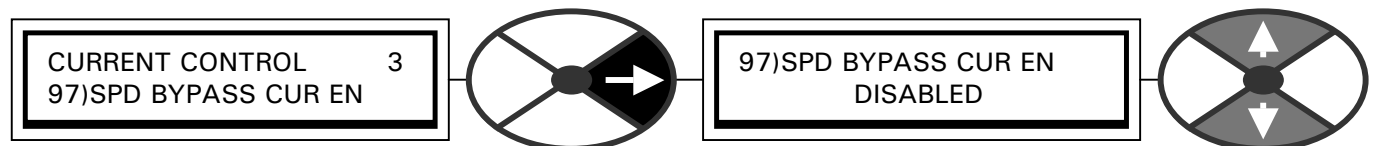

Allows a current reference input which by-passes the speed loop.	PARAMETER	RANGE	DEFAULT	PIN
	SPD BYPASS CUR EN	ENABLED OR DISABLED	DISABLED	97

There is an internal connection from T3 via UIP3 to 64)SPEED REF3 MON. This parameter determines whether T3 is a speed or current reference. If enabled, the speed loop output is automatically disconnected. Note. The summing junction for this input is shown in 6.7.1 SPEED CONTROL / Block diagram.

### 6.9 CHANGE PARAMETERS / FIELD CONTROL

PIN number range 99-114

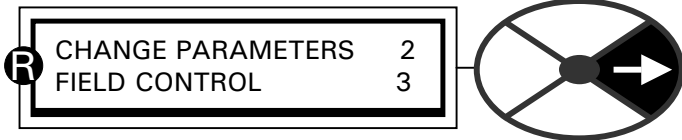

The field controller within the PL/X consists of a single phase half controlled thyristor bridge with a flywheel diode. The AC supply to the bridge is delivered through terminals EL2 and EL3, and the rectified output is on terminals F+ and F-. The supply can be anywhere in the range of 100 to 480V AC, but must, at least, be 1.1 times the maximum field output voltage you require. Note that the supply to EL2 and EL3 is also utilised to determine phase rotation of the local supply.

The purpose of the field winding in a motor is to provide flux that intersects the armature windings. The flux generated is a function of the CURRENT flowing in the field coils. When considering the set up of the field output you are able to use 1 of 2 types of control strategy.

- 1) Voltage clamp with higher current limit protection.
- 2) Current control with higher voltage clamp protection.

Motor field windings are normally very inductive and have a long time constant. This results in smooth current in the field. In this case the field current reading is reasonably accurate irrespective of when it is sampled.

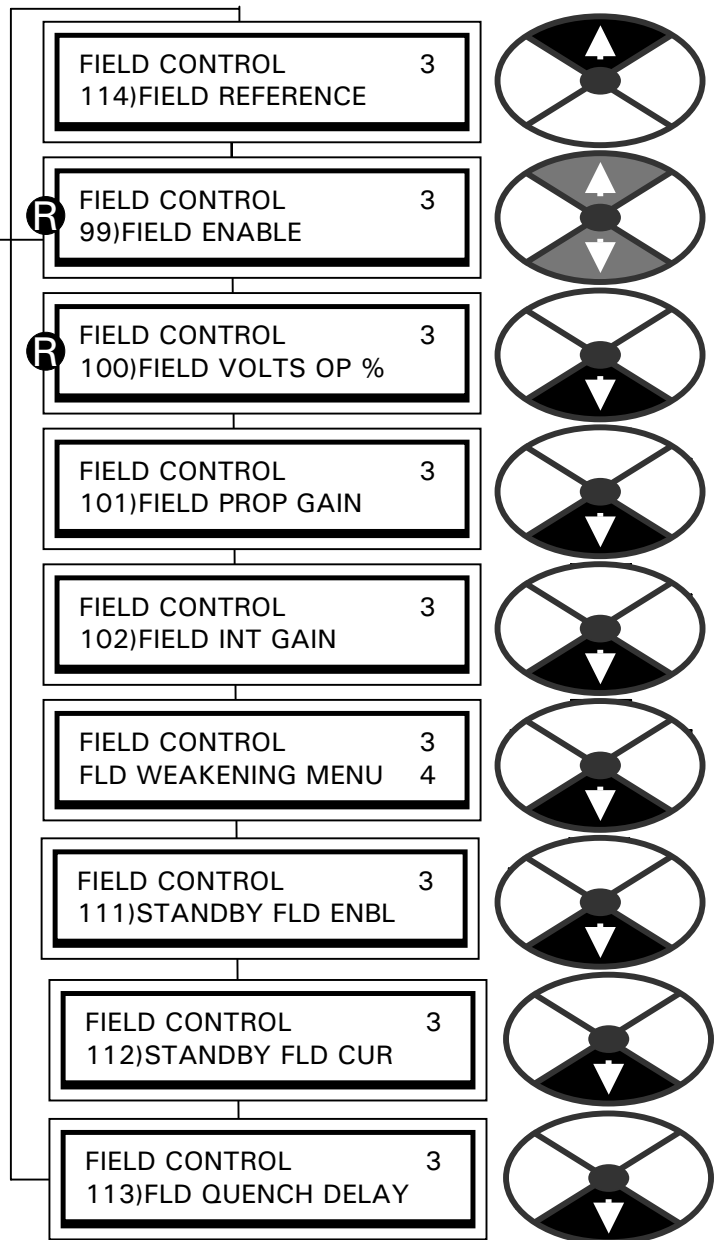

Some motors have shorter field winding time constants than normal resulting in up to 20% ripple. In this case the PL/X may sample the current at a non-ideal point in the cycle which will result in a slightly incorrect control level. (Usually no more than a few %) To normalise the field current back to its correct level it may be necessary to use the field current trim. See 6.1.12 CALIBRATION / Field current feedback trim PIN 15, or re-calibrate the field current to overcome the inaccuracy.

**Warning. Field reversal or disconnection.**

Due to the high inductance of motor fields it may take several seconds for the field current to decay to zero after the field output has been inhibited by the PL/X. **Do not open circuit the field unless the field current has reached zero.** The PL/X is unable to measure the decaying current after an inhibit, so it is not possible to use the field current monitors or field active flag to show zero current has actually been attained. It is necessary to observe the current on an external instrument and time how long it takes to decay. The interval timer block may then be utilised to implement a safety delay before opening the field circuit. Failure to observe this warning may cause flashover of the field circuit and result in damage to the system.

## 6.9.1 FIELD CONTROL / Block diagram

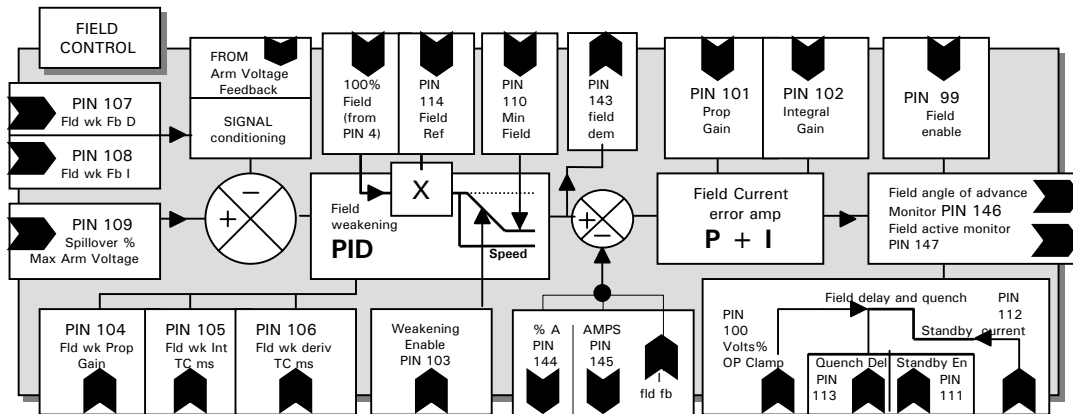

1) Voltage output clamp. This is an open loop setting of the field bridge-firing angle allowing the DC output voltage to be set between 0 to 90% of the incoming supply voltage. E. g. for an AC supply of 400V the 90% output voltage is 360V DC. Note if the AC supply varies, then the field output voltage will vary in proportion. Also if the field resistance changes then the resulting output current will change.

If you know the rated field voltage, you can set 100)FIELD VOLTS OP % clamp parameter value in this menu. Adjust the field output voltage to the dataplate value, as a % of the applied AC supply. Note. Please ensure that 4)RATED FIELD AMPS is sufficiently high to force the 100)FIELD VOLTS OP % clamp into operation, at the desired voltage, under all conditions.

4)RATED FIELD AMPS, scaled by 114)FIELD REFERENCE, sets the demand for the field current control loop and 100)FIELD VOLTS OP % operates as a clamp on the field bridge firing angle. If the current demand is satisfied at a voltage output below the clamp level, then the current loop will prevail.

2) Current control. The range of output voltage is the same in this mode as in the voltage output clamp mode, however the control loop operates on the actual current flowing in the field and works to maintain this at the desired value. Providing that the output voltage is not clamped by the 90% natural limit, or by 100)FIELD VOLTS OP %, and is able to move around, then the current delivered will always be controlled irrespective of supply and resistance changes. This is the preferred control strategy.

**Hence it is possible to operate with the field current control prevailing and the voltage % as a higher safety clamp, or the voltage % clamp prevailing and the field current control as a higher safety level.**

The back emf of a motor is a good linear representation of its speed. This is significantly improved if the field current and hence flux is kept constant. Hence with the field in **current control mode**, AVF speed control accuracy is improved. It is good practice in control engineering to minimise the error correction requirements of any loop, hence having a current controlled field is also recommended when using a tachogenerator.

Field weakening in current mode is required where the speed of the motor exceeds its base speed. The field current is held at its rated value until the armature voltage reaches its spillover value. Reducing the field current, rather than increasing the armature voltage, then satisfies any further increase in speed demand.

Further consideration must be given to the field quenching modes. If dynamic braking is required then the field must be maintained after the drive armature output is halted. Without the field, the motor would not be able to act as a generator and dissipate its rotational energy into the braking resistor.

When motors are standing still for extended periods it is useful to apply a reduced field current to prevent overheating, save energy and in cold climates prevent condensation or freezing.

For any **non running mode** the field will be quenched. If the RUN input goes low at any point during the stopping process, either heading for zero speed or during the delay period, then the contactor will drop out straight away and the field quenched. The quenched condition is determined by 111)STANDBY FIELD ENBL, 112)STANDBY FLD CUR and 113)FLD QUENCH DELAY.

See also 14.9.1 Wiring diagram for AC supply to L1/2/3 different to EL1/2/3. (E.g. Low voltage field)

6.9.2 FIELD CONTROL / Field enable PIN 99

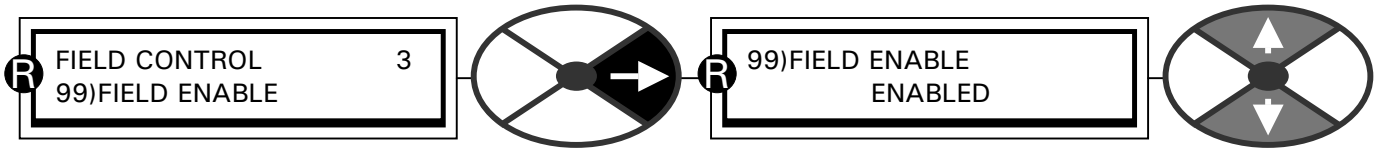

This allows the field output to be enabled or disabled.

PARAMETER	RANGE	DEFAULT	PIN
FIELD ENABLE	ENABLED OR DISABLED	ENABLED	99

Note. The field fail alarm is automatically inhibited if the field control is disabled.

6.9.3 FIELD CONTROL / Voltage output % PIN 100

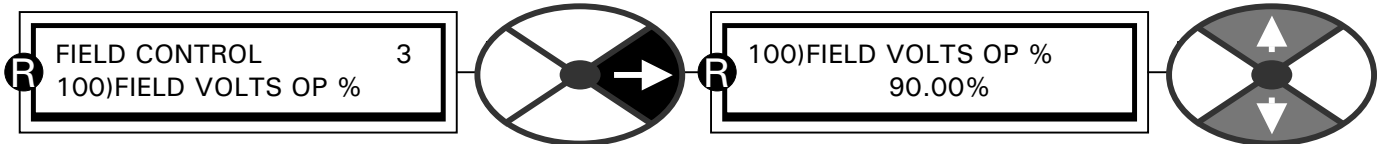

Sets the DC field voltage clamp as a % of the AC supply volts.

PARAMETER	RANGE	DEFAULT	PIN
FIELD VOLTS OP %	0.00 to 100.00%	90.00%	100

It may be necessary to set the field voltage instead of the field current. E. g. There may only be a volts rating on the dataplate. See 7.3.4 FLD I LOOP MONITOR / Field firing angle of advance monitor PIN 146.

**NOTE. The value of this parameter is not restored to the default by a 4-KEY RESET. It remains as calibrated.**

This parameter allows voltage mode to be achieved by setting an upper clamp level to the field current loop.

Note. The rated field amps current setting in the calibration menu will be a limiting value irrespective of this clamp voltage setting. This is to provide protection to the drive and the motor.

Conversely this voltage clamp setting will be a limiting value irrespective of the rated field amps setting. This means that in order to ensure that the field output voltage always remains at the clamp voltage it is necessary to set the rated field amps to a level that is slightly in excess of the cold field current.

Then as the field warms up, any voltage rise needed by the field current loop will be clamped to the level set.

The clamp will work with the rated field amps set to maximum, however this may not afford sufficiently safe protection to the motor if a problem occurs in the field winding that results in overcurrent.

See also 14.9.1 Wiring diagram for AC supply to L1/2/3 different to EL1/2/3. (E.g. Low voltage field)

6.9.4 FIELD CONTROL / Field proportional gain PIN 101

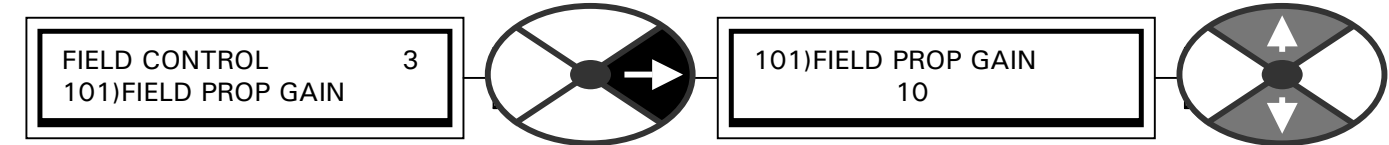

Sets the proportional gain of the field current control loop.

PARAMETER	RANGE	DEFAULT	PIN
FIELD PROP GAIN	0 to 1000	10	101

Increase to improve response, too much may cause instability in the field current.

6.9.5 FIELD CONTROL / Field integral gain PIN 102

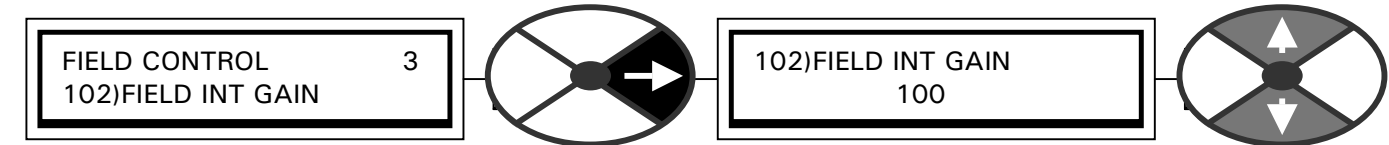

Sets the integral gain of the field current control loop.

PARAMETER	RANGE	DEFAULT	PIN
FIELD INTEGRAL	0 to 1000	100	102

Increase to improve response, too much may cause overshoot.

6.9.6 FIELD CONTROL / FLD WEAKENING MENU

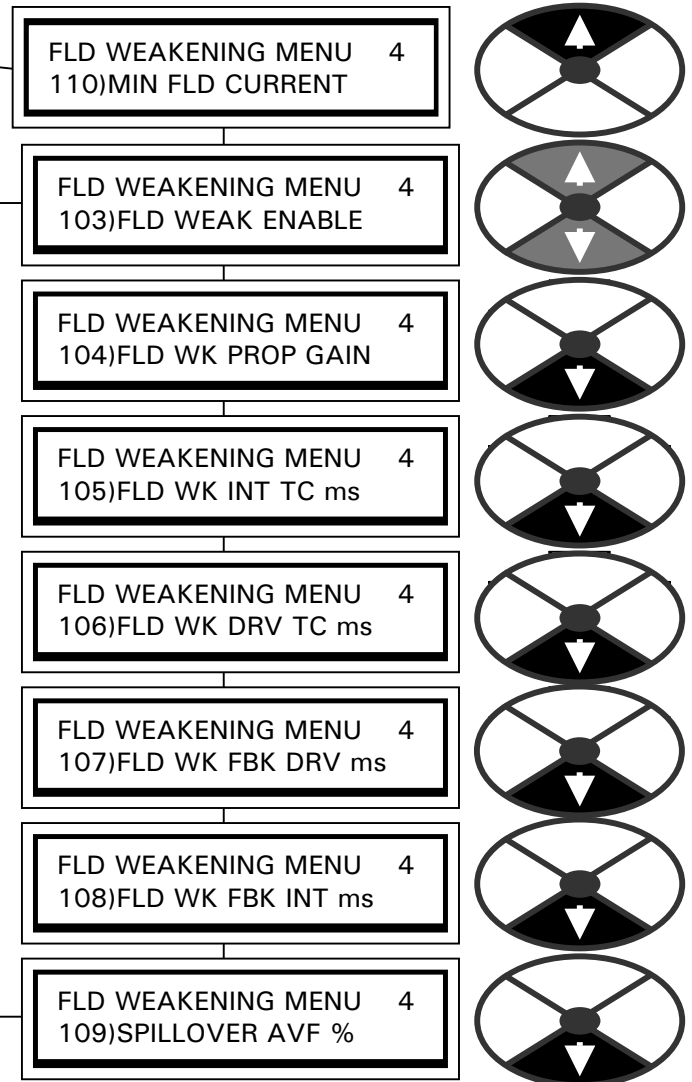
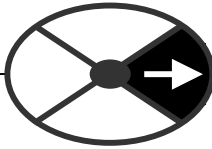

The function must be ENABLED to control field weakening.

There are 5 control terms that can be adjusted.

These are 3 error terms, derivative, proportional and integral, plus 2 feedback terms, derivative and integral. All these terms are associated with the armature voltage spillover loop and they are chosen to give the best response without excessive overshoots or instability of the armature voltage.

The control loop monitors the armature voltage and compares it to the desired spillover voltage. It then controls the field current to optimise the speed control of the drive in the field weakening region.

When the armature voltage reaches the spillover voltage, further speed increases are achieved by field weakening, and the armature voltage is effectively clamped at the spillover voltage. In this region the output power is constant for a given armature current.

See. 6.1.11 CALIBRATION / IR compensation PIN 14. Further accuracy can be achieved with IR COMP.

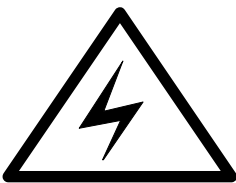

**WARNING.** When using field weakening and a DC side power contactor, the motor armature must be connected to the REMOTE AV sensing terminals T41 and T43. Failure to do this will cause flashover of the commutator because the AVF feedback is lost when the contactor opens.

**WARNING.** Do not use field weakening if Armature Voltage Feedback is selected in the CALIBRATION menu. If AVF has been selected, and field weakening enabled, then if the field weakening region is entered the drive will trip. Note. The action of changing feedback mode to AVF will automatically rescale the 100% speed feedback to refer to 18)RATED ARM VOLTS. To continue running in this mode (e.g. if tacho has failed) and avoid tripping, ensure the field weakening region is avoided by remaining at a speed which gives an armature voltage below 109)SPILLOVER AVF %.



130)MOTOR RPM monitor will read incorrectly unless 6)DESIRED MAX RPM is readjusted to base RPM.

If this trip occurs the DRIVE TRIP MESSAGE will be SPEED FBK MISMATCH.

**Note.** The limit of field weakening range is 10 : 1.

See 8.1.1 MOTOR DRIVE ALARMS / Speed feedback mismatch trip enable PIN 171.

6.9.6.1 FLD WEAKENING MENU / Field weakening enable PIN 103

FLD WEAKENING MENU 4  
 103)FLD WEAK ENABLE

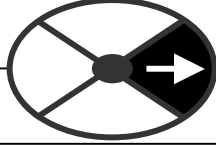

103)FLD WEAK ENABLE  
 DISABLED

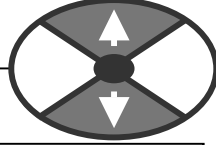

This allows the field weakening to be enabled or disabled.

PARAMETER	RANGE	DEFAULT	PIN
FLD WEAK ENABLE	ENABLED OR DISABLED	DISABLED	103

6.9.6.2 FLD WEAKENING MENU / Field weakening proportional gain PIN 104

FLD WEAKENING MENU 4  
 104)FLD WK PROP GAIN

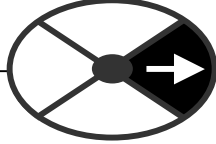

104)FLD WK PROP GAIN  
 50

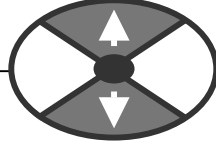

This sets the proportional gain of the field weakening loop.

PARAMETER	RANGE	DEFAULT	PIN
FLD WK PROP GAIN	0 to 1000	50	104

Generally an increased proportional value will speed up the response of the armature voltage when operating around the spillover voltage point, and a decrease will slow the response. Increasing the value too far may cause instability of the armature voltage and possible over-volting of the commutator.

6.9.6.3 FLD WEAKENING MENU / Field weakening integral time constant PIN 105

FLD WEAKENING MENU 4  
 105)FLD WK INT TC ms

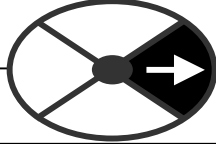

105)FLD WK INT TC ms  
 4000

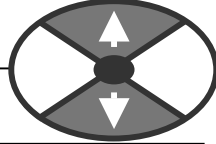

This sets the integral time constant of the weakening loop

PARAMETER	RANGE	DEFAULT	PIN
FLD WK INT TC ms	0 to 20000 ms	4000	105

Generally an increased integral time constant will slow the response of the armature voltage when operating around the spillover voltage point, and a decrease will improve the response. Decreasing the value too far may cause instability of the armature voltage and possible over-volting of the commutator.

6.9.6.4 FLD WEAKENING MENU / Field weakening derivative time constant PIN 106

FLD WEAKENING MENU 4  
 106)FLD WK DRV TC ms

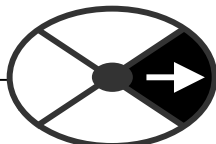

106)FLD WK DRV TC ms  
 200

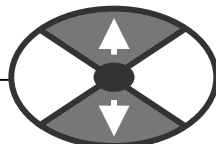

This sets the derivative time constant of the weakening loop

PARAMETER	RANGE	DEFAULT	PIN
FLD WK DRV TC ms	10 to 5000 ms	200	106

In general, keep this parameter between 5 and 10% of the setting of 105)FLD WK INT TC ms. This gives good attenuation to the response of the weakening loop at high frequencies. A higher setting may cause instability of the armature voltage and possible over-volting of the commutator.

6.9.6.5 FLD WEAKENING MENU / Field weakening feedback derivative time constant PIN 107

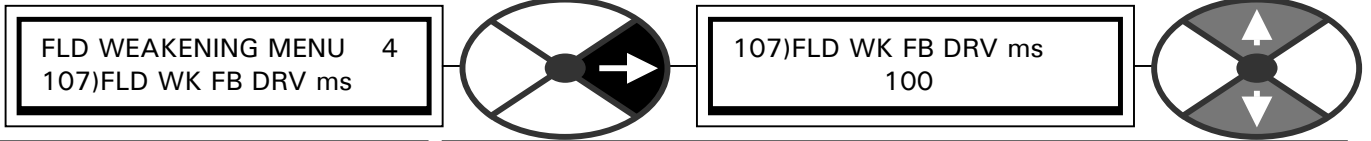

Sets the feedback derivative time constant in milliseconds.	PARAMETER	RANGE	DEFAULT	PIN
	FLD WK FB DRV ms	10 to 5000 ms	100	107

This affects the armature voltage overshoot when accelerating rapidly through base speed. An increasing ratio of 107)FLD WK FB DRV ms parameter to 108)FLD WK FB INT ms parameter (D/I) tends to reduce overshoots. A ratio of unity has no affect and a ratio of 3 or more tends to instability. The absolute values of the 2 parameters have only a 2<sup>nd</sup> order effect on the response.

6.9.6.6 FLD WEAKENING MENU / Field weakening feedback integral time constant PIN 108

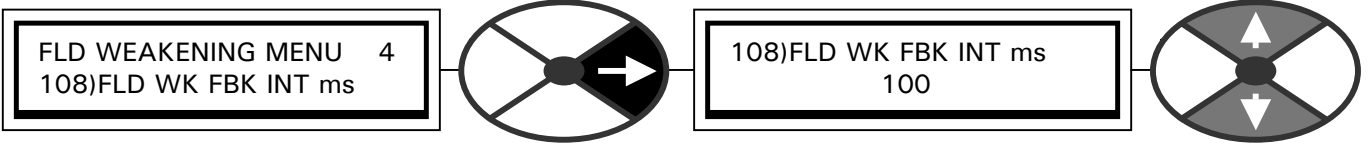

Sets the feedback integral time constant in milliseconds.	PARAMETER	RANGE	DEFAULT	PIN
	FLD WK FBK INT ms	10 to 5000 ms	100	108

This affects the armature voltage overshoot when accelerating rapidly through base speed. An increasing ratio of 107)FLD WK FB DRV ms parameter to 108)FLD WK FB INT ms parameter (D/I) tends to reduce overshoots. A ratio of unity has no affect and a ratio of 3 or more tends to instability. The absolute values of the 2 parameters have only a 2<sup>nd</sup> order effect on the response.

6.9.6.7 FLD WEAKENING MENU / Spillover armature voltage % PIN 109

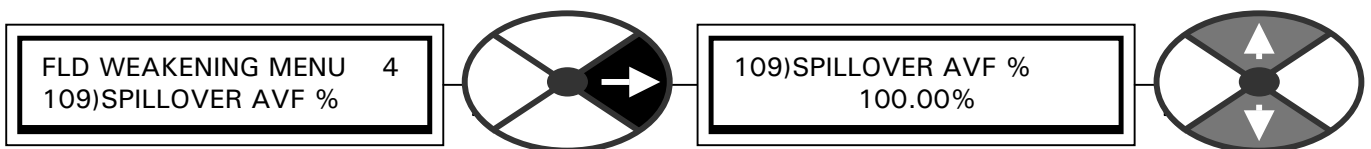

Sets armature voltage % at which field weakening begins.	PARAMETER	RANGE	DEFAULT	PIN
	SPILLOVER AVF %	0 to 100% of rated AV	100.00%	109

Note. The rated armature voltage is set in the CALIBRATION menu.

6.9.6.8 FLD WEAKENING MENU / Minimum field current % PIN 110

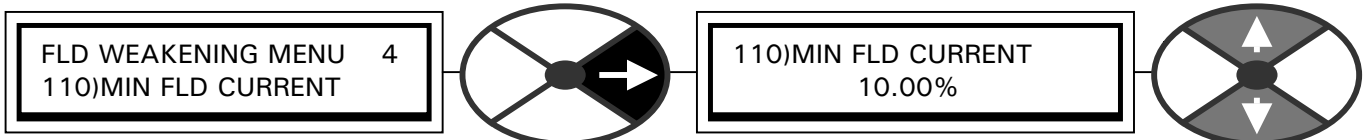

Sets the minimum field current as a % of the rated field amps.	PARAMETER	RANGE	DEFAULT	PIN
	MIN FLD CURRENT	0 to 100% of rated IF	10.00%	110

Note. When setting the minimum % allow an extra 5% margin below the desired minimum to accommodate a response transient. Do not set the minimum below 5% otherwise there may be a field failure alarm.

**WARNING.** The feedback loss protection afforded in field weakening mode is limited to total feedback loss only. This is because the speed / AVF relationship is not maintained in field weakening mode. If a partial loss of feedback occurs the motor may run to excessive speed. When the field has been completely weakened and is at its minimum level, the armature overvoltage trip will come into operation. This may only occur at a dangerous speed. It is therefore recommended that a mechanical device and or back up system be utilised to protect against this possibility. Correct setting of 110)MIN FIELD CURRENT will ensure that the overvolts TRIP occurs just above the maximum operating speed.

6.9.7 FIELD CONTROL / Standby field enable PIN 111

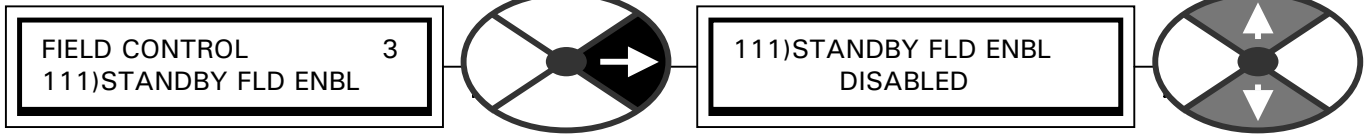

Enables the standby field quench mode.

PARAMETER	RANGE	DEFAULT	PIN
STANDBY FIELD ENBL	ENABLED OR DISABLED	DISABLED	111

Used to keep motor warm during off periods to prevent condensation in cold climates. When disabled the field quenches to zero. See 6.9.8 FIELD CONTROL / Standby field current PIN 112.

A run condition is enabled by (START or JOG) and RUN. This parameter prevails for non running conditions.

6.9.8 FIELD CONTROL / Standby field current PIN 112

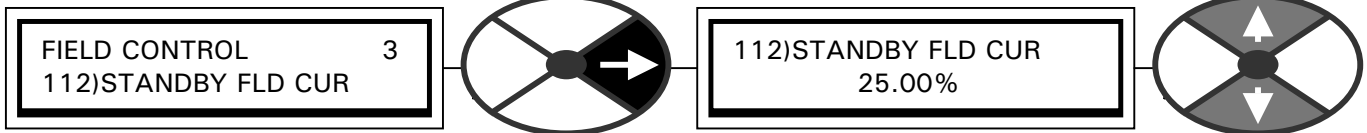

Sets the standby value of the field current.

PARAMETER	RANGE	DEFAULT	PIN
STANDBY FLD CUR	0.00% to 100.00%	25.00%	112

Used to keep motor warm during off periods to prevent condensation in cold climates.

100.00% represents 4)RATED FIELD AMPS as set in the CALIBRATION menu.

6.9.9 FIELD CONTROL / Quench delay PIN 113

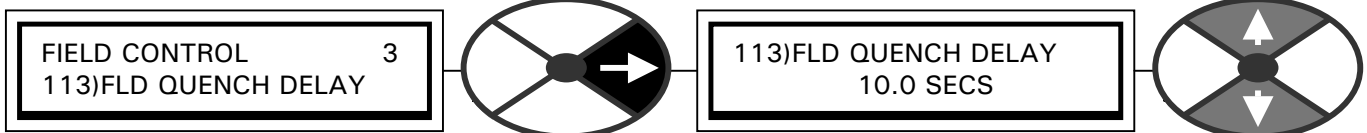

Set the field quench delay time after main contactor drop out.

PARAMETER	RANGE	DEFAULT	PIN
FLD QUENCH DELAY	0.0 to 600.0 seconds	10.0 secs	113

Used to ensure the motor can generate into a dynamic braking resistor after the main contactor drops out.

A run condition is enabled by (START or JOG) and RUN. This delay activates upon commencement of a non running condition.

6.9.10 FIELD CONTROL / Field reference input PIN 114

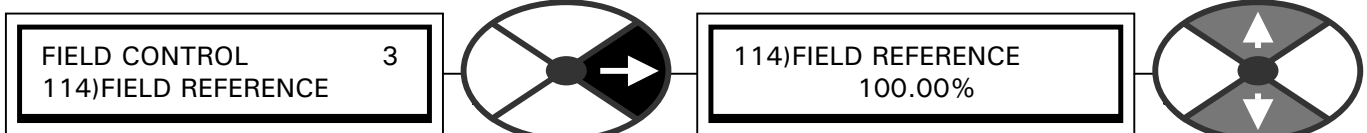

Sets the value of an external field reference input

PARAMETER	RANGE	DEFAULT	PIN
FIELD REFERENCE	0.00% TO 100.00%	100.00%	114

This parameter is a scaler of 6.1.4 CALIBRATION / Rated field amps PIN 4 QUICK START.

It may be used for systems requiring an external field reference input. The minimum field clamp will operate if the reference goes below minimum field.



## 6.10 CHANGE PARAMETERS / ZERO INTERLOCKS

PIN number range 115-121.

This menu is used to enable 2 interlocking functions that are associated with zero speed.



There normal standstill behaviour is as follows.

After the satisfying conditions of 'zero speed and current demand', **AND** 'zero speed feedback' are fulfilled, the firing pulses are removed and all other loops remain active to enable a rapid response for a new request for speed.

117)ZERO INTLK SPD % sets the threshold for both the zero speed reference and feedback decisions. 118)ZERO INTLK CUR % sets the threshold for the zero current demand decision. **If 118)ZERO INTLK CUR % is set to 0.00% then the firing pulses are not removed.**

Due to the rapid response of the above mode, it may be necessary to implement **115)STANDSTILL ENBL**. Without this quench function enabled the motor may be continuously moving as the system responds to small variations, which may be undesirable.

i) **115)STANDSTILL ENBL** provides an extra level of inhibit by not only removing the firing pulses but also quenching the loops.

It operates after the satisfying conditions of zero speed reference, and zero speed feedback are fulfilled. 117)ZERO INTLK SPD % sets the threshold for both the zero speed ref and feedback decisions.

ii) **116)ZERO REF START**. This prevents the current control being enabled after a start command, if the total speed reference to the drive, or the input to the RUN MODE RAMPS, is not at zero. It is used if starting the motor inadvertently may be undesirable. The message CONTACTOR LOCK OUT will appear after approximately 2 seconds if this function is not satisfied. The contactor is de-energised.

E. g. If an extruder is full of cold plastic, then starting it may damage the screw. By implementing this function the operator has to deliberately set the references to zero before he can commence running.

For these functions to work the zero threshold levels 117)ZERO INTLK SPD % and 118)ZERO INTLK CUR % need to be defined. All the threshold levels are symmetrical for reverse rotation and have hysteresis of +/- 0.5% around the chosen level.

For systems employing a shaft encoder there is a sub-menu for implementing spindle orientation and/or zero speed shaft position lock. In addition to the adjustable parameters there are 4 diagnostic monitoring flags.

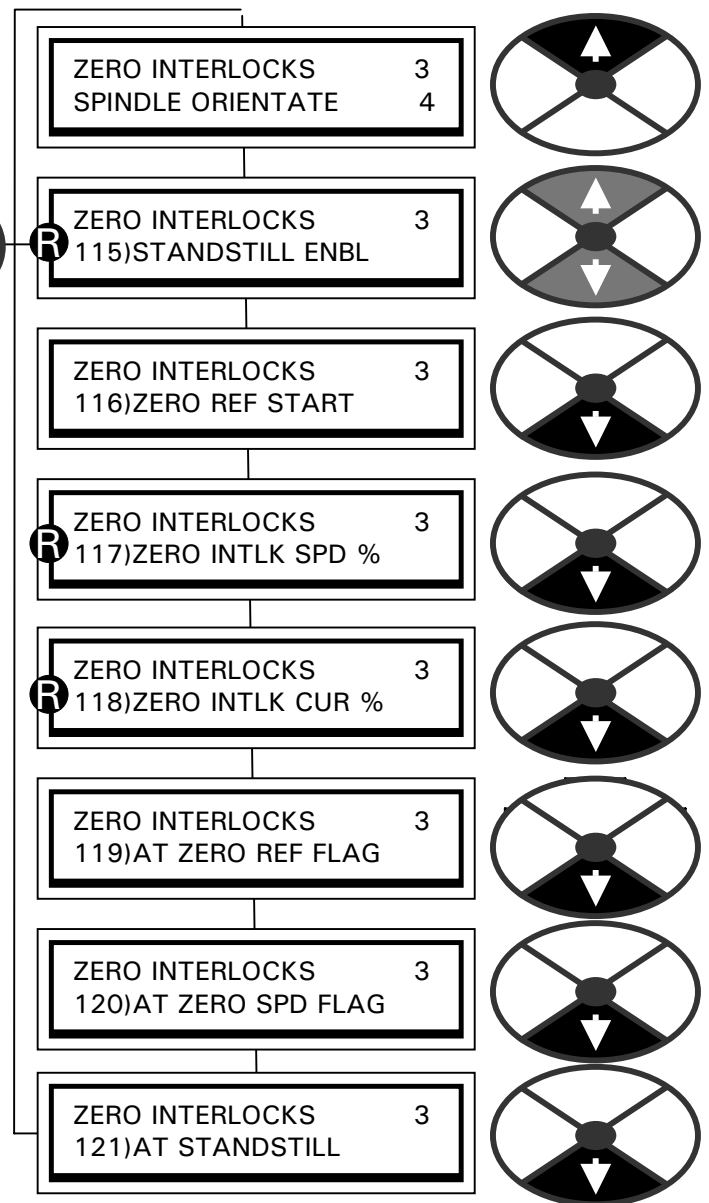

6.10.1 ZERO INTERLOCKS / Block diagram

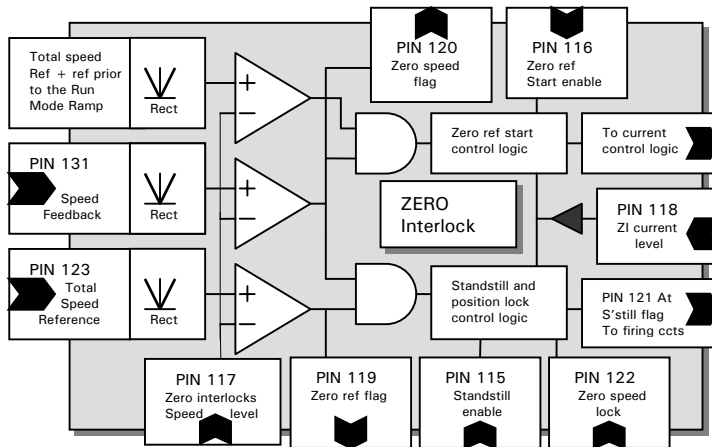

6.10.2 ZERO INTERLOCKS / Standstill enable PIN 115

R

ZERO INTERLOCKS  
 115)STANDSTILL ENBL

3

→

R

115)STANDSTILL ENBL  
 DISABLED

PARAMETER	RANGE	DEFAULT	PIN
STANDSTILL ENBL	ENABLED OR DISABLED	DISABLED	115

Allows the standstill function to be enabled.

If enabled, the standstill function will inhibit the stack firing when there is zero reference AND zero speed.

This parameter must be DISABLED for 6.10.9 ZERO INTERLOCKS / SPINDLE ORIENTATE operation.

6.10.3 ZERO INTERLOCKS / Zero reference start enable PIN 116

R

ZERO INTERLOCKS  
 116)ZERO REF START

3

→

R

116)ZERO REF START  
 DISABLED

PARAMETER	RANGE	DEFAULT	PIN
ZERO REF START	ENABLED OR DISABLED	DISABLED	116

Allows the zero reference start function to be enabled.

6.10.4 ZERO INTERLOCKS / Zero interlocks speed level PIN 117

R

ZERO INTERLOCKS  
 117)ZERO INTLK SPD %

3

→

R

117)ZERO INTLK SPD %  
 1.00%

PARAMETER	RANGE	DEFAULT	PIN
ZERO INTLK SPD %	0.00 to 100.00%	1.00%	117

Sets speed level for the zero ref start and standstill blocks.

The signals being detected are total speed reference and speed feedback. The input depends on the function (total speed reference for standstill, and total speed inputs prior to the normal ramp for zero reference start). This speed level also sets the threshold for 120)AT ZERO SPD FLAG.

6.10.5 ZERO INTERLOCKS / Zero interlocks current level PIN 118

ZERO INTERLOCKS 3  
118)ZERO INTLK CUR %

118)ZERO INTLK CUR %  
1.50%

Sets current % for the zero ref start and standstill blocks.

PARAMETER	RANGE	DEFAULT	PIN
ZERO INTLK CUR %	0.00 to 100.00%	1.50%	118

6.10.6 ZERO INTERLOCKS / At zero reference flag PIN 119

ZERO INTERLOCKS 3  
119)AT ZERO REF FLAG

119)AT ZERO REF FLAG  
LOW

Allows the total speed reference zero status to be monitored.

PARAMETER	RANGE	PIN
AT ZERO REF FLAG	HIGH (at zero) or LOW	119

Branch hopping facility to next window.

6.10.7 ZERO INTERLOCKS / At zero speed flag PIN 120

ZERO INTERLOCKS 3  
120)AT ZERO SPD FLAG

120)AT ZERO SPD FLAG  
LOW

Allows the zero speed status to be monitored.

PARAMETER	RANGE	PIN
AT ZERO SPD FLAG	HIGH (at zero) or LOW	120

Branch hopping facility to adjacent windows.

6.10.8 ZERO INTERLOCKS / At standstill flag PIN 121

ZERO INTERLOCKS 3  
121)AT STANDSTILL

121)AT STANDSTILL  
LOW

Allows the standstill function status to be monitored.

PARAMETER	RANGE	PIN
AT STANDSTILL	HIGH (at standstill) or LOW	121

This flag operates irrespective of the state of 115)STANDSTILL ENBL.

6.10.8.1 Low speed performance

When running at very low speeds the SPEED PI ADAPTION may need adjustment for optimum performance. The SPEED PI ADAPTION default settings are designed to give lower gain with low error. This provides smooth steady state performance. However applications that require precise control at very low speeds may function better with the adaption disabled.

If the adaption is required to be on during normal running and off at low speeds then use a MULTIFUNCTION block to connect an inversion of 120)AT ZERO SPD FLAG to 79)SPD ADAPT ENABLE.

See 6.7.7.6 SPEED PI ADAPTION / Speed loop adaption enable PIN 79

See 6.7.7.7 SPEED PI ADAPTION / Using small speed inputs and 6.5.1.4 Precise stopping

6.10.9 ZERO INTERLOCKS / SPINDLE ORIENTATE

PINS used 122 and 240 to 244

**Note.** It is only possible to use this function with PLX models, and PL models with the regenerative stopping facility. See 3.3.1.

ZERO INTERLOCKS	3
SPINDLE ORIENTATE	4

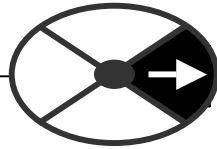

This sub menu is used to provide spindle orientation. It requires the mechanical system to be fitted with an incremental encoder with bi-directional output to provide position feedback.

If the encoder has been selected for a speed feedback option in the CALIBRATION menu then that function is not disturbed by this block being operational.

The spindle orientation will function irrespective of the speed feedback type.

The block utilises the encoder marker to provide the controller with the absolute position angle of the encoder. The marker is input via terminal T15.

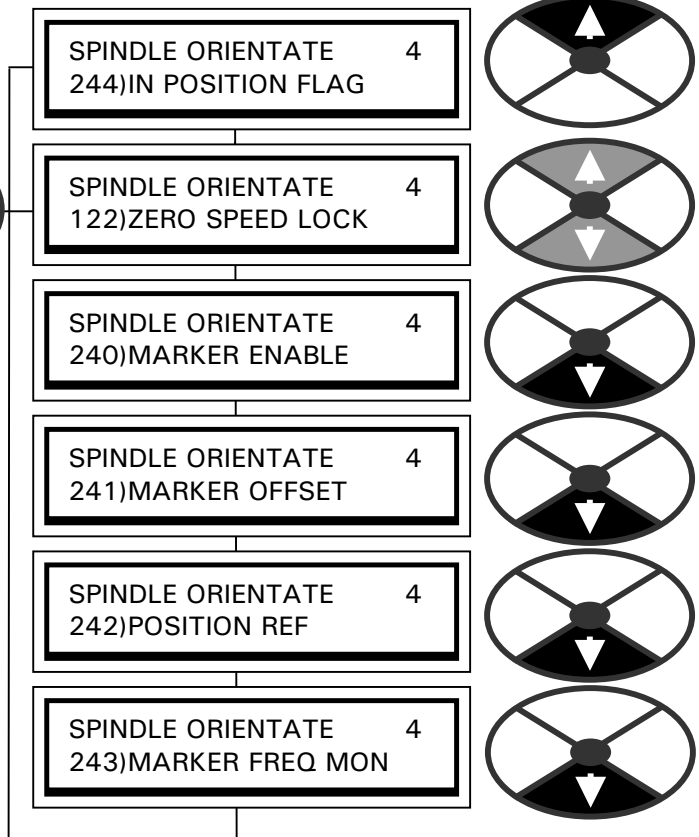

PL models with the regenerative stopping facility can only orientate during the contactor drop out delay.

To maintain position lock during a contactor drop out delay ensure 6.5.4 STOP MODE RAMP / Live delay mode PIN 58 is set to ENABLED. See also 6.5.6 STOP MODE RAMP / Drop-out delay PIN 60.

The encoder pulses are input on terminals T16 and T17 (Note. Quadrature type encoders are recommended because they will usually provide more accurate counting during reversals than Pulse and direction types). Terminals T15, T16, T17 are also used as standard logic inputs. (DIP/2/3/4). This function continues to operate. However logic levels that are changing at a frequency of greater than 20 Hz will not necessarily be recognised by the standard logic input function. The standard logic input function can be useful to check logic output levels of a slowly rotated encoder during commissioning.

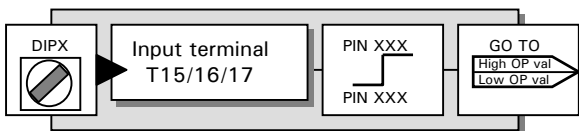

The encoder input type and scaling is programmed by using the CALIBRATION / ENCODER SCALING menu to select the encoder type, sign, encoder lines and rpm.

The SPINDLE ORIENTATE block counts the pulses from the encoder in a bi-directional counter. It counts forward or backward depending on rotation direction. This count represents the amount of angular rotation of the encoder and hence the motor shaft. The position count is compared with the required spindle orientation position reference to develop an error signal which is employed in a negative feedback loop in the drive. Thus the motor will rotate in such a direction as to reduce the error to zero, and hence bring the encoder marker to the spindle position reference.

The marker uniquely defines the absolute position of the rotating encoder to the machine. If 241)MARKER OFFSET and 242)POSITION REF are both zero, then the encoder shaft will be positioned at the marker. However it is more than likely that the marker will be in an arbitrary position. To overcome this problem, 241)MARKER OFFSET is provided to perform a one off positioning of the shaft to a known position, every time the spindle orientate is actioned. E. g. to top dead centre. 242)POSITION REF is then always referred to this known position.

**To summarise.**

The orientation function is activated by dropping below the zero speed threshold. 241)MARKER OFFSET is actioned only once at the commencement of orientation, and 242)POSITION REF is then followed with respect to the 241)MARKER OFFSET position. The orientation function is de-activated by increasing the speed demand above the zero speed threshold.

242)POSITION REF may be changed as many times as required and the shaft position will track it relative to the 241)MARKER OFFSET position. Each time 242)POSITION REF is changed to a new value, the 244)IN POSITION FLAG may be used to determine when the new position has been achieved.

The gain and hence response of the position control loop is set by 122)ZERO SPEED LOCK. A value of zero will **turn off** the position loop. The block also provides 243)MARKER FREQ MON giving marker frequency.

For systems that require position locking at zero speed but the absolute position is not important, then 122)ZERO SPEED LOCK only may be used. In this case no marker is required, and the 240)MARKER ENABLE input should be set to disabled.

## 6.10.9.1 SPINDLE ORIENTATE / Block diagram

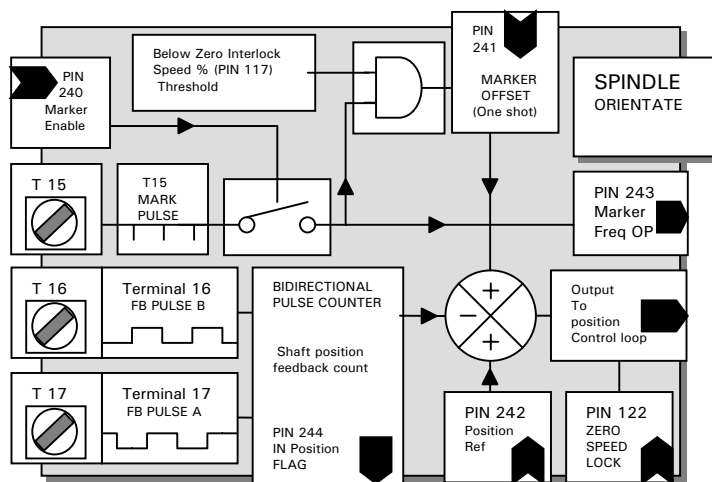

## 6.10.9.1.1 Spindle orientate operation

For all speeds above 117)ZERO INTLK SPD %, the spindle orientate control action is disabled. However the marker frequency monitor will function within its defined limits providing 240)MARKER ENABLE is enabled.

**Note. The marker that is used for orientation is the last one to be input prior to the speed falling below 117)ZERO INTLK SPD % threshold.** ( This is normally within 1 revolution of the shaft prior to the threshold).

When the speed falls below 117)ZERO INTLK SPD %, then the spindle orientate function will operate providing 122)ZERO SPEED LOCK is set to a non-zero value and 240)MARKER ENABLE is enabled. Once the block has commenced functioning, it will continue as long as the speed demand is below 117)ZERO INTLK SPD %. The actual speed may exceed 117)ZERO INTLK SPD % without turning the block off.

The sequence of operation is as follows.

- 1) Speed demand and feedback fall and remain below 117)ZERO INTLK SPD % for 400mS. (Includes Stopping sequences using terminals T33 or T32). (\*PL models can only orientate when stopping).
- 2) Spindle orientation block is activated.
- 3) The shaft position at the last marker to be input prior to the speed falling below 117)ZERO INTLK SPD % is calculated by the PL/X.
- 4) The shaft seeks the 241)MARKER OFFSET position.
- 5) As the shaft approaches the marker offset position the block checks for the 242)POSITION REF target.

- 6) If the position reference is non-zero, the shaft immediately seeks the position reference with respect to the marker offset without waiting to stop at the marker offset position.
- 7) When the shaft reaches 242)POSITION REF target, 244)IN POSITION FLAG goes high.
- 8) If a new 242)POSITION REF is entered, the shaft immediately seeks the new 242)POSITION REF target.
- 9) When the shaft reaches the new 242)POSITION REF target, then 244)IN POSITION FLAG goes high again.
- 10) The sequence of 8 and 9 may be repeated as many times as desired as long as the speed demand remains below 117)ZERO INTLCK SPD %.
- 11) The speed demand rises above 117)ZERO INTLCK SPD % and the block is turned off.

Note. Both 241)MARKER OFFSET and/or 242)POSITION REF may be positive or negative, giving a choice of clock/anti-clockwise search. This is used if the speed direction changes, and shaft reversal is undesirable. To provide smoother stopping it may be helpful to use position references that include extra complete turns. The block waits for approximately 400mS before activating to allow undisturbed speed traverse through zero.

There are 2 hidden PINs which allow access to the position counter (e.g. with serial link). PIN 710 gives a running total. (4 counts per line in quadrature mode or 2 counts per line in single pulse train mode). PIN 711 is a decimal number input in the range 1 to 30,000 which is usually sent by a host computer. This is used to divide the total position count so that the receiving host does not have to poll at a high rate.

6.10.9.2 SPINDLE ORIENTATE / Zero speed lock PIN 122

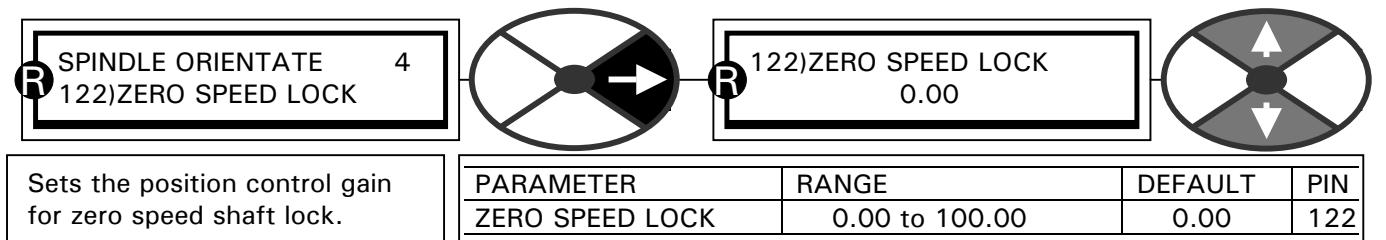

Sets the position control gain for zero speed shaft lock.

Note, If this value is non-zero, **AND** both speed demand and feedback are less than 117)ZERO INTLCK SPD% an encoder position control loop activates. **The motor must have a bi-directional output shaft encoder. (Quadrature OR pulse and direction).** When locked, the speed may exceed 117)ZERO INTLCK SPD% without losing the lock. Lock is only released by speed demand > 117)ZERO INTLCK SPD%.

Suggested value 10.00. Increasing improves position response, excessive gain may cause position instability. See 6.1.9 CALIBRATION / Speed feedback type PIN 9 QUICK START.

Warning. PL PILOT may add up to 10mS to PL/X cycle times, which may affect the response of applications that require fast sampling. Eg SPINDLE ORIENTATE. To overcome this effect, reduce the PL PILOT baud rate.

6.10.9.3 SPINDLE ORIENTATE / Marker enable PIN 240

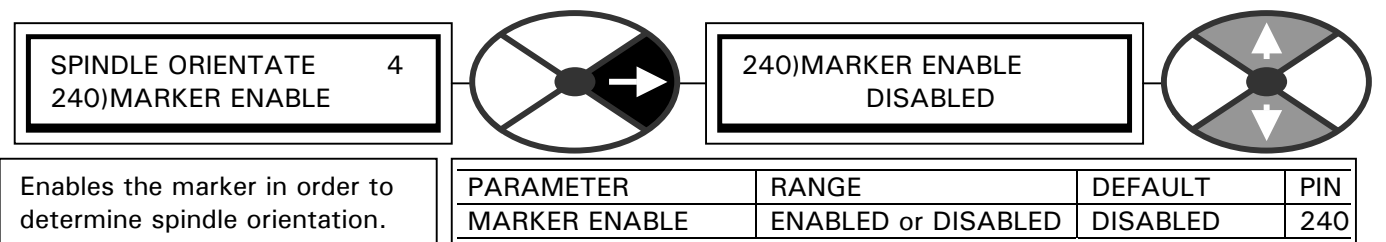

Enables the marker in order to determine spindle orientation.

DISABLED turns off the spindle orientate function and the marker frequency monitor function.  
 Note, 122)ZERO SPEED LOCK function will continue to work however stopping position is arbitrary.

6.10.9.3.1 Marker specification

The logic threshold levels for T15 are 0 < 2V, 1 > 4V. The maximum input voltage is 50V. The minimum width specification for the marker is 10 uS.

The precise point of reference is the rising edge of the marker. Various types of marker signal may be used with the system, but some types are less prone to noise than others.

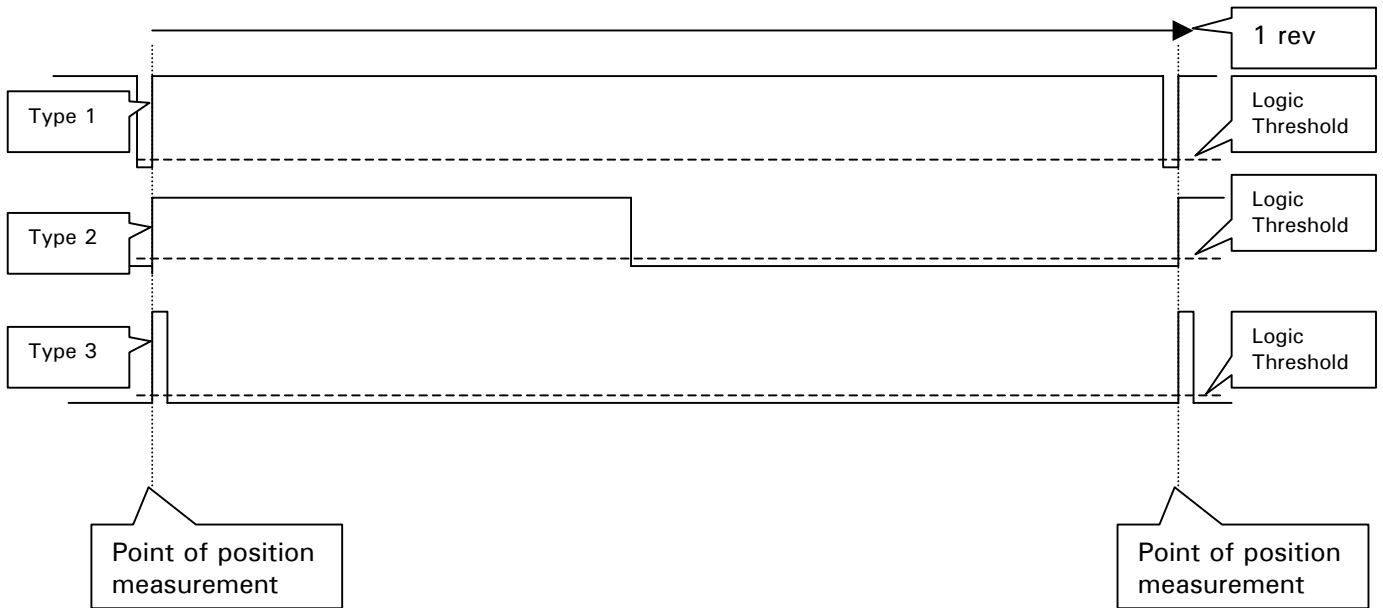

Type 1 is the preferred marker signal. This is because for most of the time the signal is well away from the logic threshold and noise is very unlikely to cause a false marker reading.

Types 2 and 3 however spend significant time near the logic threshold level, and therefore noise is more prone to produce a false marker reading.

6.10.9.4 SPINDLE ORIENTATE / Marker offset PIN 241

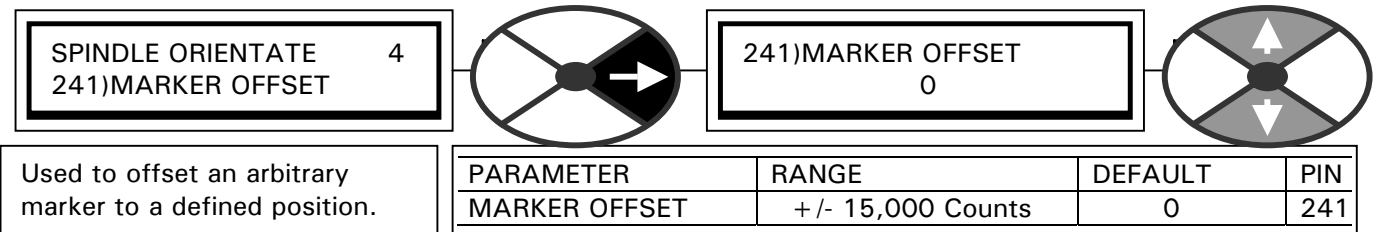

Note. This offset is only added once at the commencement of orientation. It may be changed prior to the next orientation sequence without affecting the existing position. The sign of the offset determines the rotation direction when seeking the offset.

The count value needed for any offset angle depends on the resolution of the feedback encoder and the type of encoder output. Quadrature encoders provide 4 counts per line. Single pulse and direction encoders provide 2 counts per line.

E.g. Encoder has 3600 lines. Encoder type is QUADRATURE.  
 This gives 3600 X 4 counts per rev = 14400. That is 14400/360 = 40 counts per degree of displacement.  
 Hence if offset required is 56.8 degrees. Then enter counts of 56.8 X 40 = 2272.

E.g. Encoder has 2048 lines. Encoder type is SINGLE LINE PLUS DIRECTION.  
 This gives 2048 X 2 counts per rev = 4096. That is 4096/360 = 11.378 counts per degree of displacement.  
 Hence if offset required is 56.8 degrees. Then enter counts of 56.8 X 11.378 = 646.

If the encoder is mounted on the motor shaft, but the spindle that requires orientation is connected to the motor via a gearbox such that the motor shaft and hence encoder is rotating faster than the spindle. Then the number of counts per rev of the spindle will be increased by a factor equal to the gear box ratio.

E. g. Counts per degree at the motor shaft = 40. Reduction gearbox ratio = 3 : 1. Then counts per degree at the spindle = 120. Note. In systems with reduction gearboxes, the motor encoder will provide more than one marker per rev of the spindle. There are 2 ways of overcoming this problem.

1) Provide another marker which only occurs once per rev of the spindle. E.g. A magnetic pick up sensing a tab on the spindle.

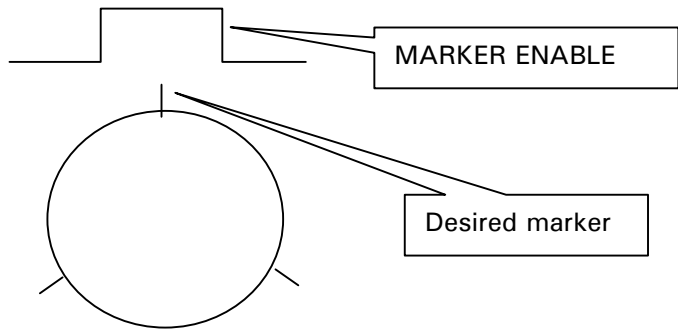

**OR**

2) Use 240)MARKER ENABLE parameter to select the required marker at the appropriate position. This may be achieved by using a microswitch that operates while the required marker is present but not with the other markers.

6.10.9.5 SPINDLE ORIENTATE / Position reference PIN 242

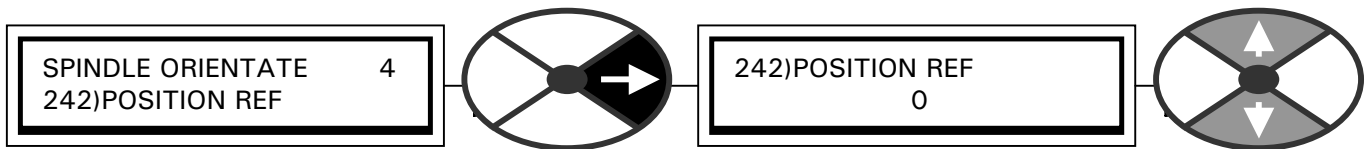

Used to enter POSITION REF referred to MARKER OFFSET

PARAMETER	RANGE	DEFAULT	PIN
POSITION REF	+/- 30,000 counts	0 counts	242

Note. 242)POSITION REF may be adjusted at any time. If the system is above the zero lock threshold then changing this value has no effect. It may be changed as many times as required whilst operating in the zero speed lock region.

6.10.9.6 SPINDLE ORIENTATE / Marker frequency monitor PIN 243

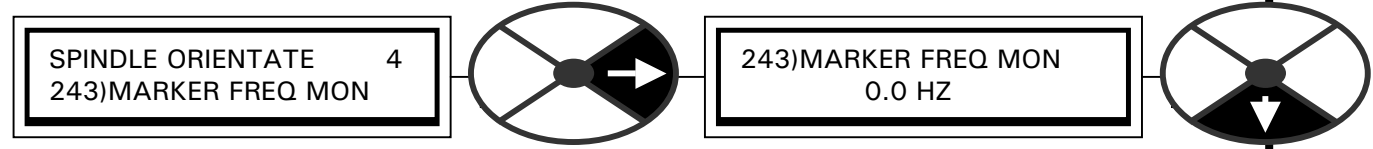

Monitors the frequency of the marker pulse on T15.

PARAMETER	RANGE	DEFAULT	PIN
MARKER FREQ MON	20.00 to 655.37 HZ	0.0 HZ	243

This output function measures the period between successive marker pulses to accurately compute the output frequency. This window has a branch hopping facility.

Note. For frequencies below 20 Hz, the monitor will display a random reading.

6.10.9.7 SPINDLE ORIENTATE / In position flag PIN 244

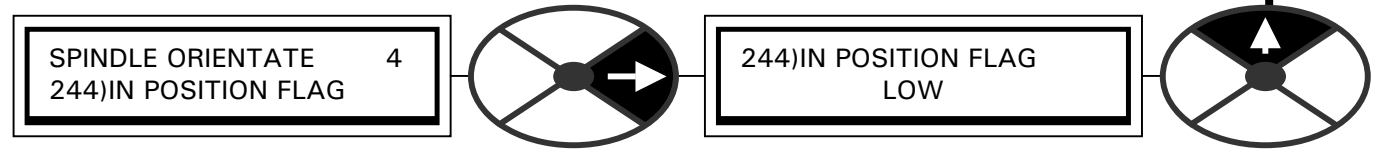

This goes high if the position error is approx < 10 counts.

PARAMETER	RANGE	DEFAULT	PIN
IN POSITION FLAG	LOW or HIGH	LOW	244

Note. The flag may oscillate whilst the loop is settling if 122)ZERO SPEED LOCK (gain) is high enough to cause overshoot. This window has a branch hopping facility.



# 7 DIAGNOSTICS

**7 DIAGNOSTICS ..... 121**

7.1 DIAGNOSTICS / SPEED LOOP MONITOR ..... 122

7.2 DIAGNOSTICS / ARM I LOOP MONITOR..... 125

7.3 DIAGNOSTICS / FLD I LOOP MONITOR ..... 128

7.4 DIAGNOSTICS / ANALOG IO MONITOR ..... 130

7.5 DIAGNOSTICS / DIGITAL IO MONITOR ..... 131

7.6 DIAGNOSTICS / BLOCK OP MONITOR ..... 133

7.7 DIAGNOSTICS / EL1/2/3 RMS MON PIN 169 ..... 134

7.8 DIAGNOSTICS / DC KILOWATTS MON PIN 170 ..... 134

See also 5.1.6 Default % DIAGNOSTIC summary windows.

### DIAGNOSTICS menu

PIN number range 123 to 170

The diagnostics menu provides a monitoring facility for all the main drive parameters.



If an adjustable parameter has been configured to be a GOTO target, its value is then a monitor of the source and is no longer adjustable.

The unit consists of functional software blocks that each perform a given task within the overall block diagram. Some of these blocks are permanently connected e. g. armature current loop. Application blocks however are only functioning when their output is connected using a GOTO.

See 13.2.1 Key features of GOTO window.

The diagnostics menu is provided for monitoring the important parameters within the permanently functioning blocks, as listed in this menu.

The Application and some other block outputs are all gathered together in the BLOCK OP MONITOR. For most blocks, the monitoring points are also found within the block menus themselves.

Also there are some less important parameters that may be useful to monitor, that may be found in their block menu, rather than the diagnostics menu.

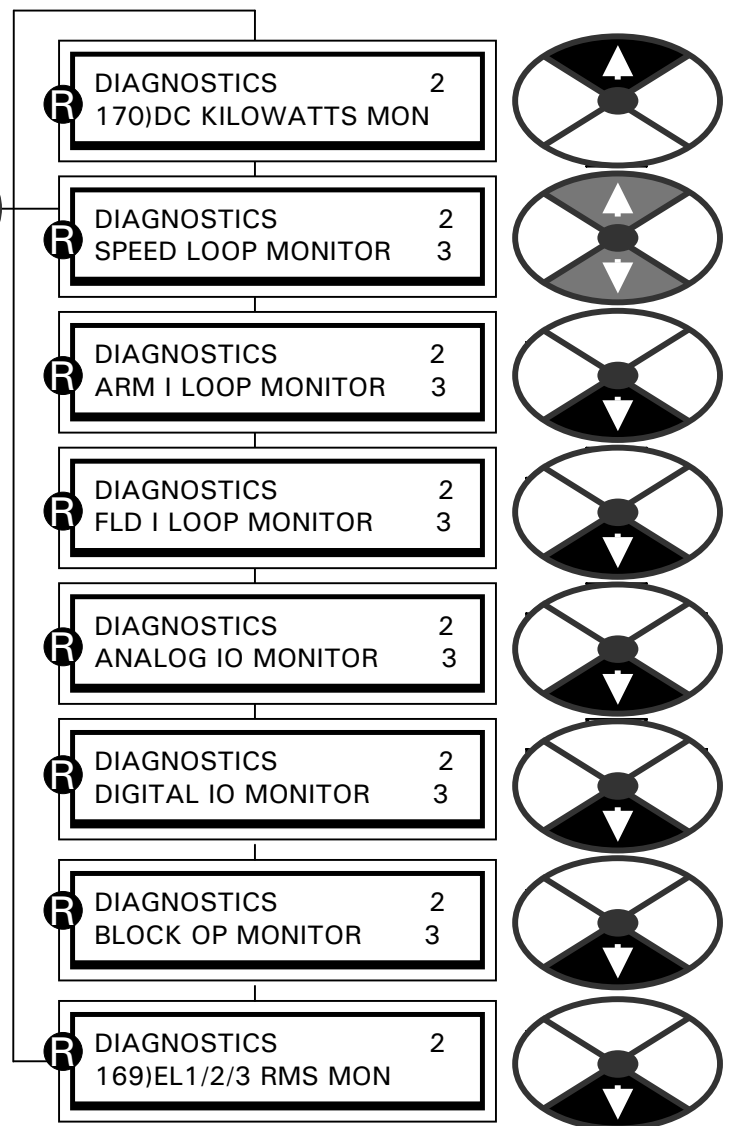

Note. When you travel right by tapping the right key in the diagnostics menu you will eventually come to the end of a branch which will display the parameter to be monitored. The UP key hops to the end of the branch above, and the DOWN key hops to the end of the branch below giving rapid access to the monitored parameters within each sub-menu. It also provides a reminder that you are not in a parameter changing menu, where this branch hopping feature is not available.

### 7.1 DIAGNOSTICS / SPEED LOOP MONITOR



PIN number range 123 to 132

This menu allows monitoring of the parameters associated with the the speed loop.

The feedback sources can also be read in engineering units which alleviates the need to undertake difficult readings with a voltmeter during commissioning.

For convenience, the armature voltage is also shown as a % of max rated value in a dedicated window.

The armature volts, tacho volts and encoder rpm monitors all function continuously, irrespective of which is the source of feedback. These signal channels may be utilised for tasks other than speed feedback.

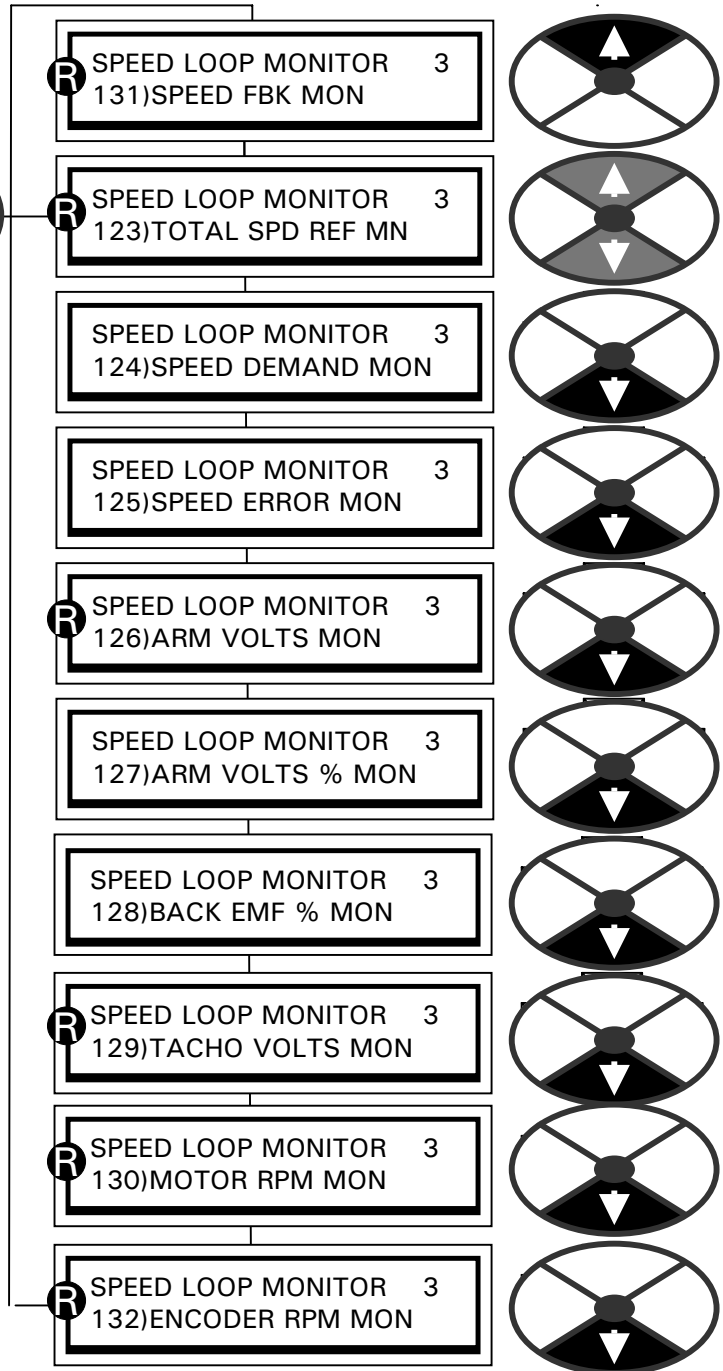

#### 7.1.1 SPEED LOOP MONITOR / Total speed reference monitor PIN 123

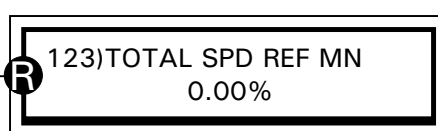
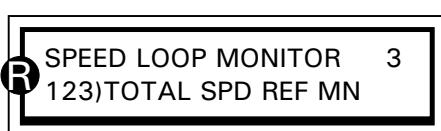

Shows the % value of the total speed reference before the STOP RAMP BLOCK.

PARAMETER	RANGE	PIN
TOTAL SPD REF MN	+/-300.00%	123

This parameter is a summation of all possible speed references including the RUN MODE RAMP. Note that the RUN MODE RAMP may be active when the unit is in stop mode. This feature allows cascaded systems to function even if a member of the system is stopped. See 6.2 CHANGE PARAMETERS / RUN MODE RAMPS.

7.1.2 SPEED LOOP MONITOR / Speed demand monitor PIN 124

SPEED LOOP MONITOR 3  
124)SPEED DEMAND MON

124)SPEED DEMAND MON  
0.00%

Shows the % value of the total speed demand after the STOP RAMP BLOCK

PARAMETER	RANGE	PIN
SPEED DEMAND MON	+/-300.00%	124

7.1.3 SPEED LOOP MONITOR / Speed error monitor PIN 125

SPEED LOOP MONITOR 3  
125)SPEED ERROR MON

125)SPEED ERROR MON  
0.00%

Shows the value of the speed error as a % of full scale.

PARAMETER	RANGE	PIN
SPEED ERROR MON	+/-300.00%	125

7.1.4 SPEED LOOP MONITOR / Armature volts monitor PIN 126

**R** SPEED LOOP MONITOR 3  
126)ARM VOLTS MON

**R** 126)ARM VOLTS MON  
0.0 Volts

Shows the average DC armature voltage independently of feedback type.

PARAMETER	RANGE	PIN
ARM VOLTS MON	+/- 1250.0 Volts	126

7.1.5 SPEED LOOP MONITOR / Armature volts % monitor PIN 127

SPEED LOOP MONITOR 3  
127)ARM VOLTS % MON

127)ARM VOLTS % MON  
0.00%

Shows the value of the average DC arm voltage as a % of desired max arm volts.

PARAMETER	RANGE	PIN
ARM VOLTS % MON	+/-300.00%	127

Note. The 100% level is equivalent to 18)RATED ARM VOLTS

7.1.6 SPEED LOOP MONITOR / Back emf % monitor PIN 128

SPEED LOOP MONITOR 3  
128)BACK EMF % MON

128)BACK EMF % MON  
0.00%

Shows the value of the average DC back emf as a % of the desired max back emf.

PARAMETER	RANGE	PIN
BACK EMF % MON	+/-300.00%	128

Note. Back EMF = AVF - IR drop

7.1.7 SPEED LOOP MONITOR / Tachogenerator volts monitor PIN 129

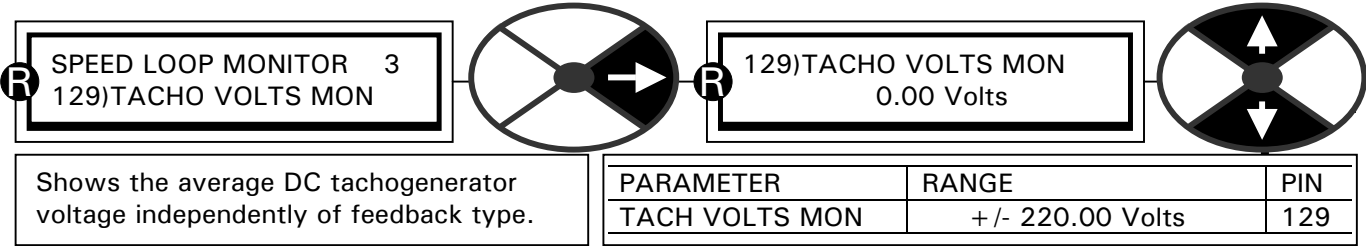

Shows the average DC tachogenerator voltage independently of feedback type.

Note. There is an unfiltered % version of this value on hidden PIN 716.

7.1.8 SPEED LOOP MONITOR / Motor RPM monitor PIN 130

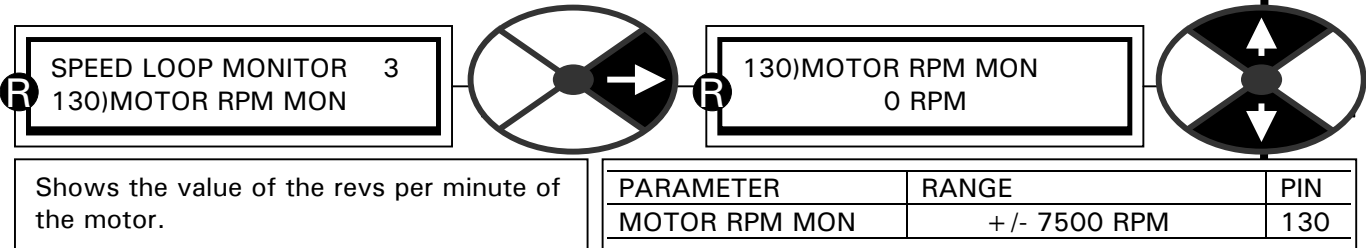

Shows the value of the revs per minute of the motor.

Note. 130)MOTOR RPM MON will only be accurate when

- 1) In AVF feedback mode 18)RATED ARM VOLTS corresponds to 6)DESIRED MAX RPM, for 100% speed.
- 2) In ANALOG TACHO feedback mode 8)MAX TACHO VOLTS corresponds to 6)DESIRED MAX RPM, for 100% speed.

Note. There is an unfiltered version of this value on hidden PIN 717.

7.1.9 SPEED LOOP MONITOR / Encoder RPM monitor PIN 132

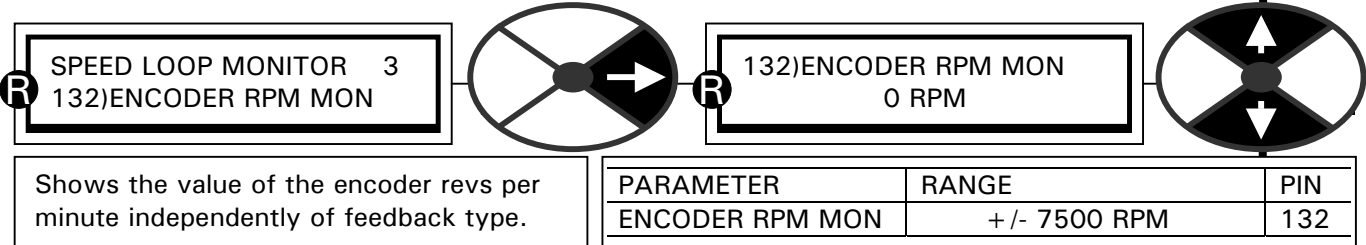

Shows the value of the encoder revs per minute independently of feedback type.

There is a % equivalent of this signal on hidden pin 709)MOTOR RPM %.

See also 6.1.10.3 ENCODER SCALING / Motor / encoder speed ratio PIN 12.

7.1.10 SPEED LOOP MONITOR / Speed feedback % monitor PIN 131

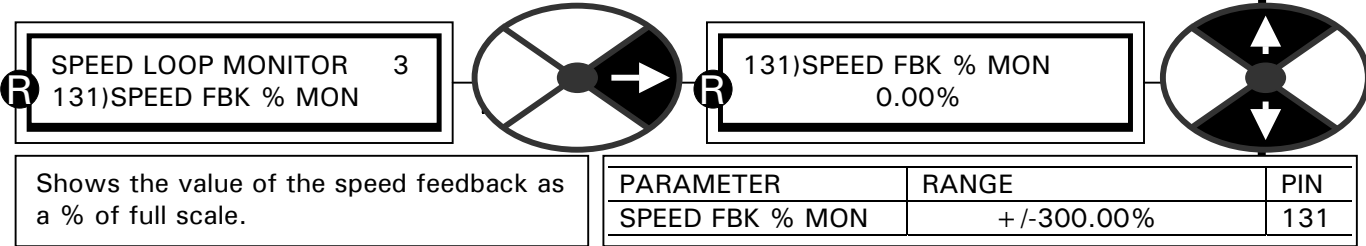

Shows the value of the speed feedback as a % of full scale.

Note. There is an unfiltered version of this value on hidden PIN 715.

### 7.2 DIAGNOSTICS / ARM I LOOP MONITOR

PIN number range 133 to 141



This menu allows monitoring of the parameters associated with the inputs to the current loop.

The feedback current can be read in amps which alleviates the need to undertake difficult readings with an ammeter during commissioning.

For convenience the armature current is also shown as a % of max rated value in a dedicated window.

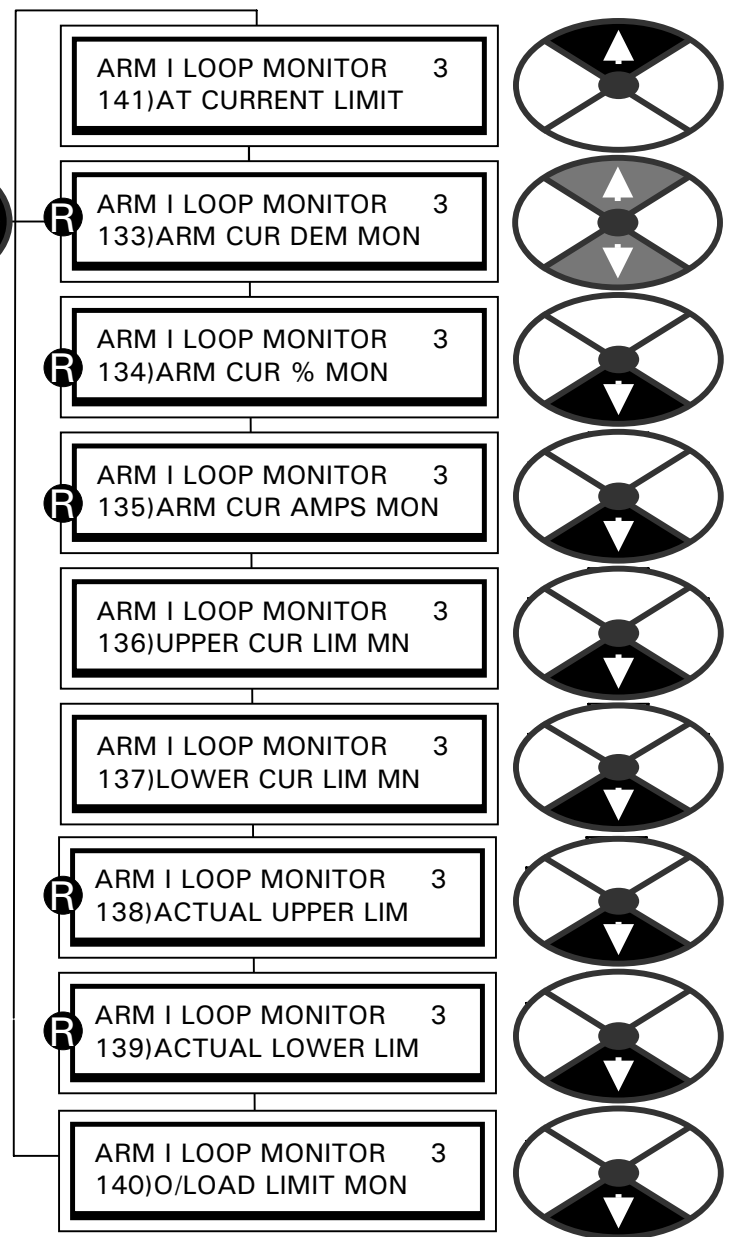

7.2.1 ARM I LOOP MONITOR / Armature current demand monitor PIN 133

ARM I LOOP MONITOR 3  
133)ARM CUR DEM MON

133)ARM CUR DEM MON  
0.00%

Shows the value of the total armature current demand as a % of full scale.

PARAMETER	RANGE	PIN
ARM CUR DEM MON	+/-150.00%	133

Note. There is a hidden PIN 718 which contains an unfiltered version of current demand.

7.2.2 ARM I LOOP MONITOR / Armature current % monitor PIN 134

ARM I LOOP MONITOR 3  
134)ARM CUR % MON

134)ARM CUR % MON  
0.00%

Shows the value of the average DC arm current as a % of rated arm amps.

PARAMETER	RANGE	PIN
ARM CUR % MON	+/-150.00%	134

Note. There is an unfiltered version of this value on hidden PIN 719.

7.2.3 ARM I LOOP MONITOR / Armature current amps monitor PIN 135

ARM I LOOP MONITOR 3  
135)ARM CUR AMPS MON

135)ARM CUR AMPS MON  
0.0 AMPS

Shows the value of the average DC armature current in amps.

PARAMETER	RANGE	PIN
ARM CUR AMPS MON	+/-3000.0 AMPS	135

7.2.4 ARM I LOOP MONITOR / Upper current limit monitor PIN 136

ARM I LOOP MONITOR 3  
136)UPPER CUR LIM MN

136)UPPER CUR LIM MN  
0.00%

Shows the % value of the scaled upper current limit in the current clamp block.

PARAMETER	RANGE	PIN
UPPER CUR LIM MN	+/- 150.00%	136

This is the last stage clamp in the block diagram. See 6.8.1 CURRENT CONTROL / Block diagram.

7.2.5 ARM I LOOP MONITOR / Lower current limit monitor PIN 137

ARM I LOOP MONITOR 3  
137)LOWER CUR LIM MN

137)LOWER CUR LIM MN  
0.00%

Shows the % value of the scaled lower current limit in the current clamp block.

PARAMETER	RANGE	PIN
LOWER CUR LIM MN	+/- 150.00%	137

This is the last stage clamp in the block diagram. See 6.8.1 CURRENT CONTROL / Block diagram.

7.2.6 ARM I LOOP MONITOR / Actual prevailing upper/ lower current limits PINs 138 / 139

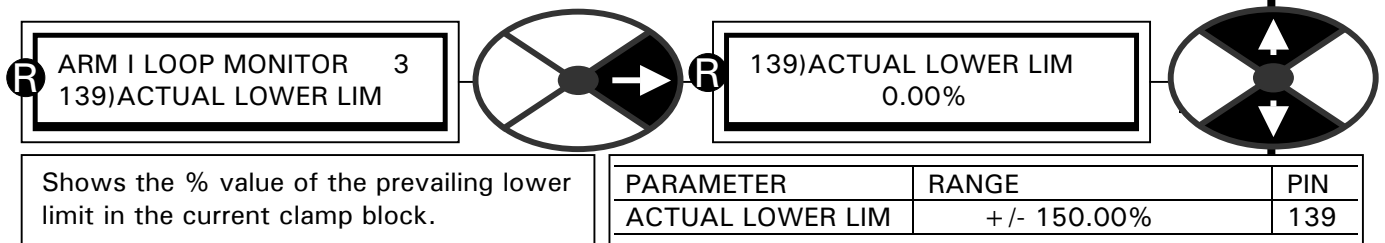
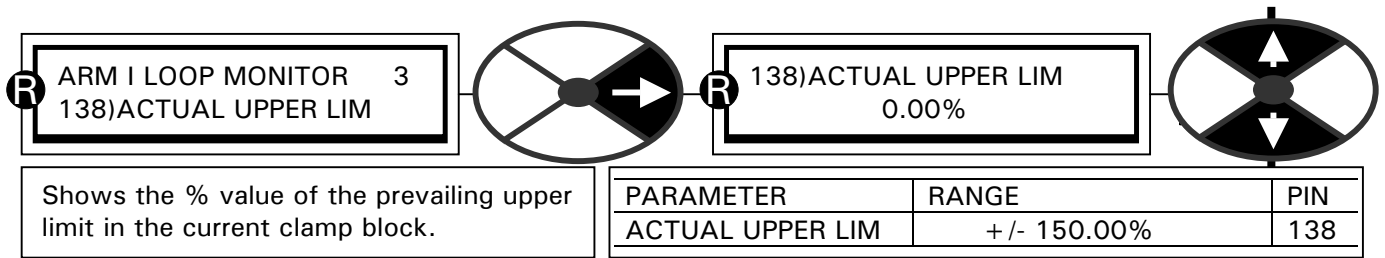

The lowest of all clamps is the prevailing source. See 6.8.1 CURRENT CONTROL / Block diagram.

7.2.7 ARM I LOOP MONITOR / Overload limit monitor PIN 140

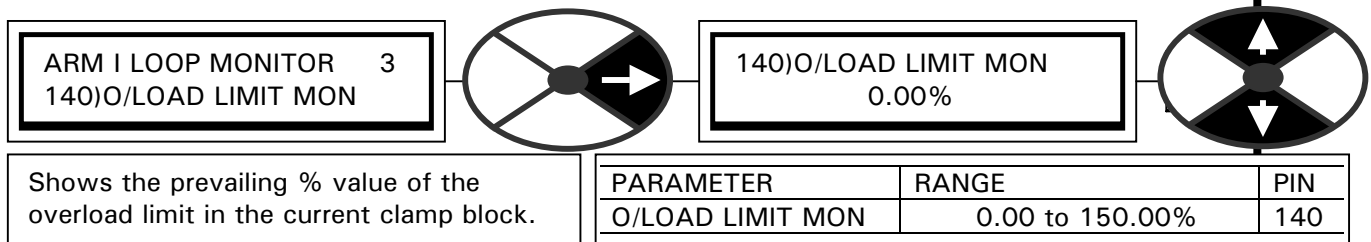

7.2.8 ARM I LOOP MONITOR / At current limit flag PIN 141

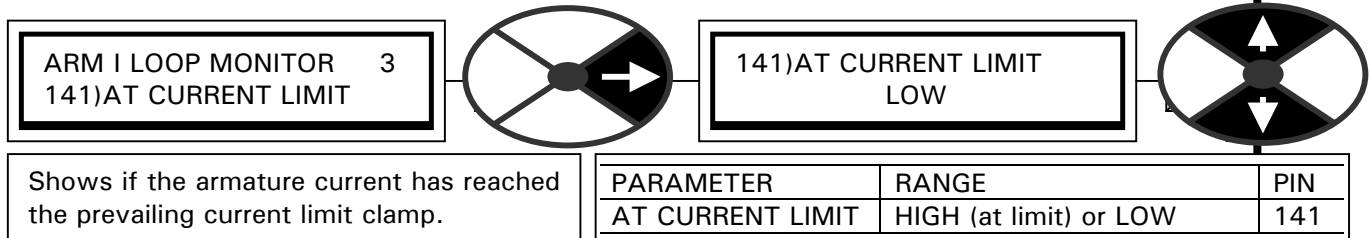

### 7.3 DIAGNOSTICS / FLD I LOOP MONITOR

PIN number range 143-147.



This menu allows monitoring of the parameters associated with the field control loop.

The motor field current can be read in amps which alleviates the need to undertake difficult readings with an ammeter during commissioning

For convenience the field current is also shown as a % of max rated value in a dedicated window.

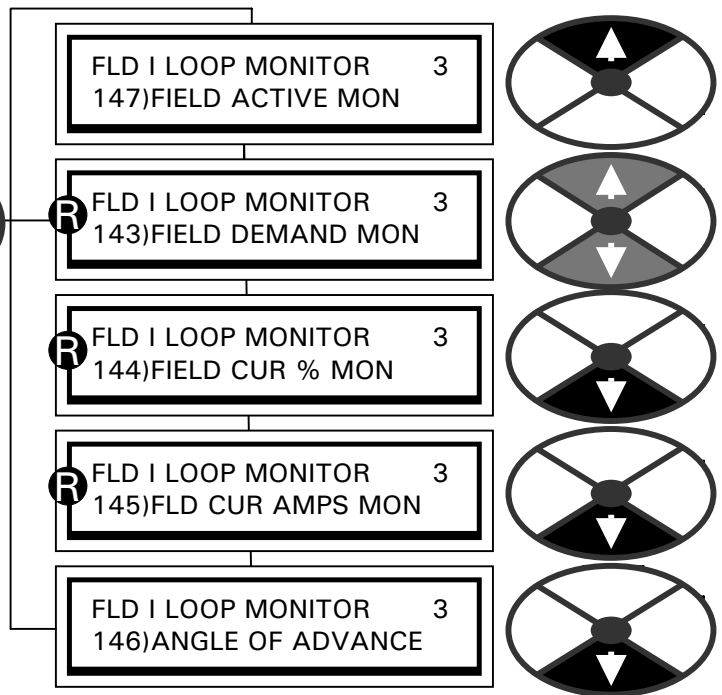

#### 7.3.1 FLD I LOOP MONITOR / Field demand monitor PIN 143

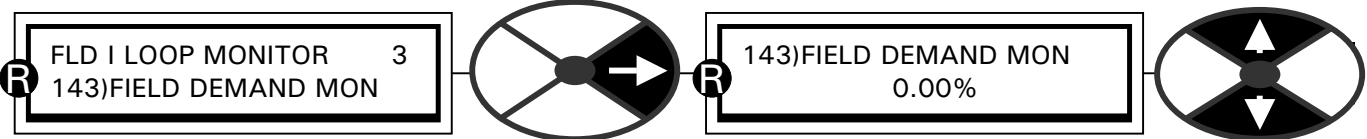

Shows the value of the field current demand as a % of full scale.

PARAMETER	RANGE	PIN
FIELD DEMAND MON	0.00 to 100.00%	143

#### 7.3.2 FLD I LOOP MONITOR / Field current % monitor PIN 144

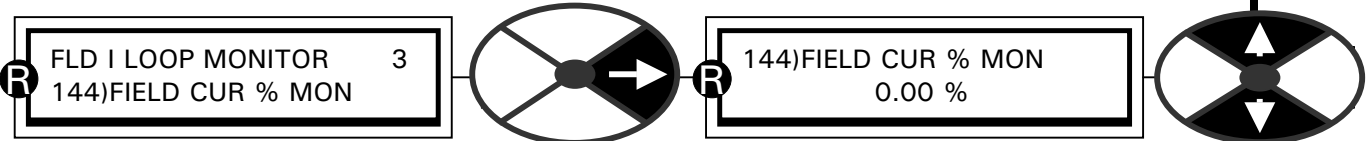

Shows the value of the average DC motor field current as a % of rated field amps.

PARAMETER	RANGE	PIN
FIELD CUR % MON	0.00 to 125.00%	144

#### 7.3.3 FLD I LOOP MONITOR / Field current amps monitor PIN 145

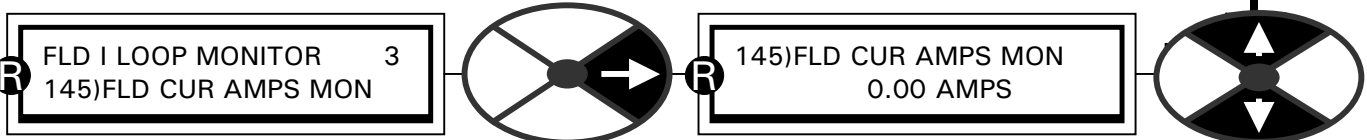

Shows the value of the average DC motor field current in amps.

PARAMETER	RANGE	PIN
FLD CUR AMPS MON	0.00 to 50.00 AMPS	145



7.3.4 FLD I LOOP MONITOR / Field firing angle of advance monitor PIN 146

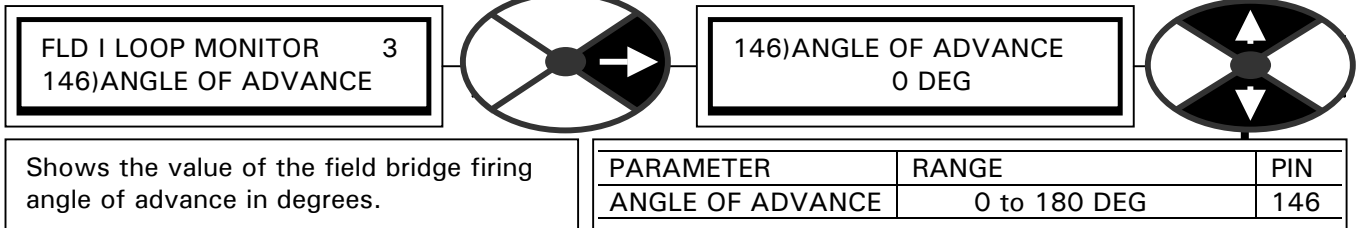

Shows the value of the field bridge firing angle of advance in degrees.

PARAMETER	RANGE	PIN
ANGLE OF ADVANCE	0 to 180 DEG	146

Note this parameter is only updated if the field is enabled. The convention used is 0 degrees is no firing and 180 degrees is full firing. The formula for calculating the field volts is as follows  
 Volts = 0.45 \* AC supply volts \* (1-cos alpha). (Firing angle of advance (degrees) = alpha)

**Field volts table.** Note. The result is rounded down then reduced by 1 volt due to the drop in the field bridge.

Firing angle (deg)	AC supply 200	AC supply 240	AC supply 380	AC supply 415	AC supply 480
25	Minimum field	Minimum field	Minimum field	Minimum field	Minimum field
30	12	14	22	24	28
40	20	24	39	42	49
50	31	37	60	65	76
60	44	53	84	92	107
70	58	70	111	121	141
80	73	88	140	154	177
90	89	107	170	185	215
100	104	125	199	218	252
110	119	143	228	249	288
120	134	161	255	279	324
130	146	176	279	305	353
140	157	189	300	328	380
150	166	200	318	347	402
160	173	208	330	361	416
170	177	213	338	369	427
177	179	215	341	372	430

After about 150 degrees there is only about 5% more volts available. This is important to realise when operating in the current control mode. In order to maintain the correct current, the volts must be able to move higher as the field warms up and the field winding resistance increases. Also it is necessary to allow a margin for supply tolerance.

This means that when the field is at its highest operating temperature the firing angle should not normally exceed 150 degrees to be sure of preventing saturation of the control loop. A typical field winding resistance will change by about 20% between cold and running temperature. Hence the maximum cold firing angle will be at about 125 degrees. If the field loop does saturate, then the speed loop will have to work harder to maintain control. In AVF (Armature voltage feedback) systems the speed holding may be less accurate.

7.3.5 FLD I LOOP MONITOR / Field active monitor PIN 147

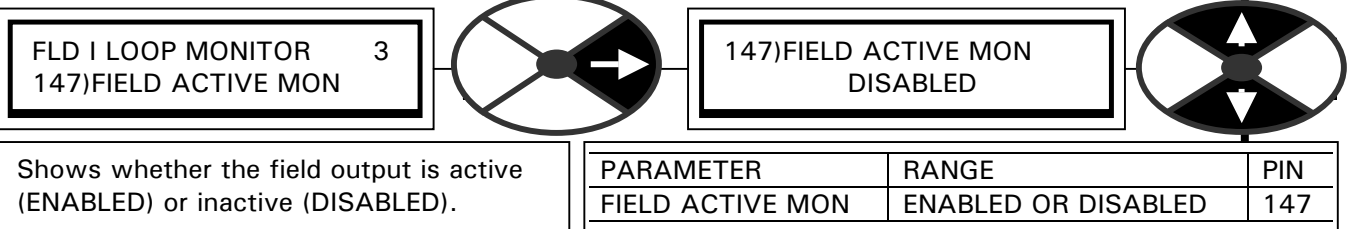

Shows whether the field output is active (ENABLED) or inactive (DISABLED).

PARAMETER	RANGE	PIN
FIELD ACTIVE MON	ENABLED OR DISABLED	147

### 7.4 DIAGNOSTICS / ANALOG IO MONITOR

PIN number range 150 -161

This menu allows monitoring of the analogue input and output functions.

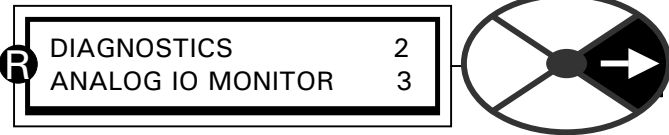

Analogue inputs are UIP2 to UIP9. The UIP number corresponds to its terminal number. (UIP1 is used internally and not available on a terminal).

UIP2 to 9 are universal inputs and can be used as digital and/or analogue inputs. The analogue value appears in this menu and the digital logic level will simultaneously appear in the digital IO menu.

Note that the analogue output monitor for AOP1/2/3 shows the value written to that output. If the output is overloaded or shorted then the value shown will not agree with the actual output.

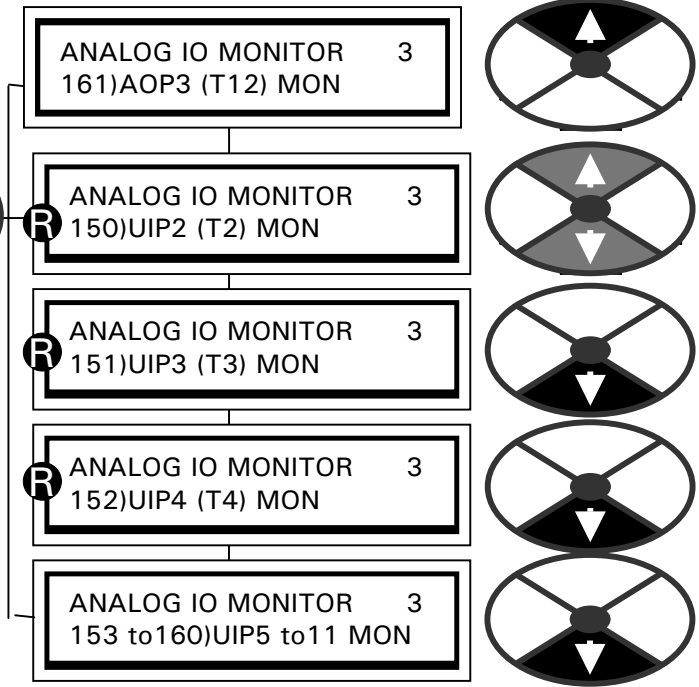

The PL/X possesses a very useful commissioning tool, 260)SCOPE OP SELECT. When enabled, this automatically configures AOP3 on terminal 12 as an oscilloscope probe output. See 13.4.3 ANALOG OUTPUTS / Scope output select PIN 260. The output is automatically connected to whatever parameter is being displayed, and reconnected to its original source after the function is no longer enabled.

#### 7.4.1 ANALOG IO MONITOR / UIP2 to 9 analogue input monitor PINs 150 to 157

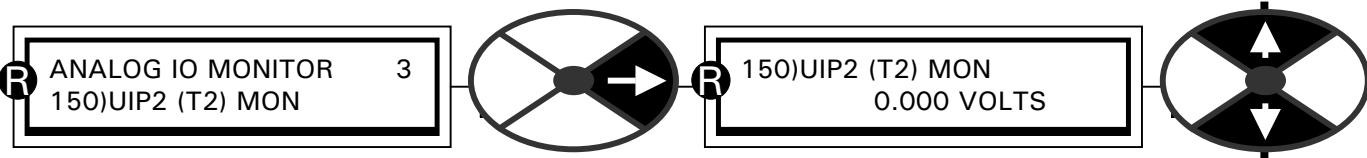

Shows the analogue voltage for the universal inputs 2 to 9.

PARAMETER	RANGE	PINs
UIPX (TX) MON	+/-30.800 volts	150 - 7

Note. There is a separate window for each input. The PINs are 150 to 157 for UIP2 to UIP9  
 The monitoring range depends on the UIP range selected. +/-5, +/-10, +/-20, or +/-30V  
 Range for 5V is +/- 5.3V Absolute accuracy worst case 0.4%, typically 0.1%.  
 Range for 10V is +/-10.4V Absolute accuracy worst case 0.4%, typically 0.1%.  
 Range for 20V is +/- 20.6V Absolute accuracy worst case 4%, typically 1%.  
 Range for 30V is +/- 30.8V Absolute accuracy worst case 4%, typically 1%.

#### 7.4.2 ANALOG IO MONITOR / AOP1/2/3 analogue output monitor PINs 159, 160, 161

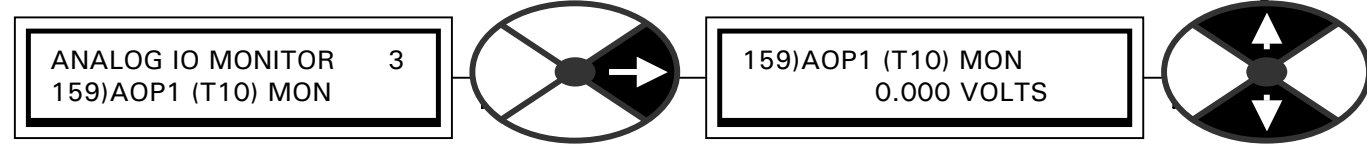

Shows the analogue output voltage for AOP1/2/3 (PIN numbers 159, 160, 161)

PARAMETER	RANGE	PINs
AOPX (TXX) MON	+/-11.300 volts	159-161

Note. The analogue output monitor for AOP1/2/3 shows the value written to that output. If the output is overloaded or shorted then the value shown will not agree with the actual output.

### 7.5 DIAGNOSTICS / DIGITAL IO MONITOR

PIN number range 162-169

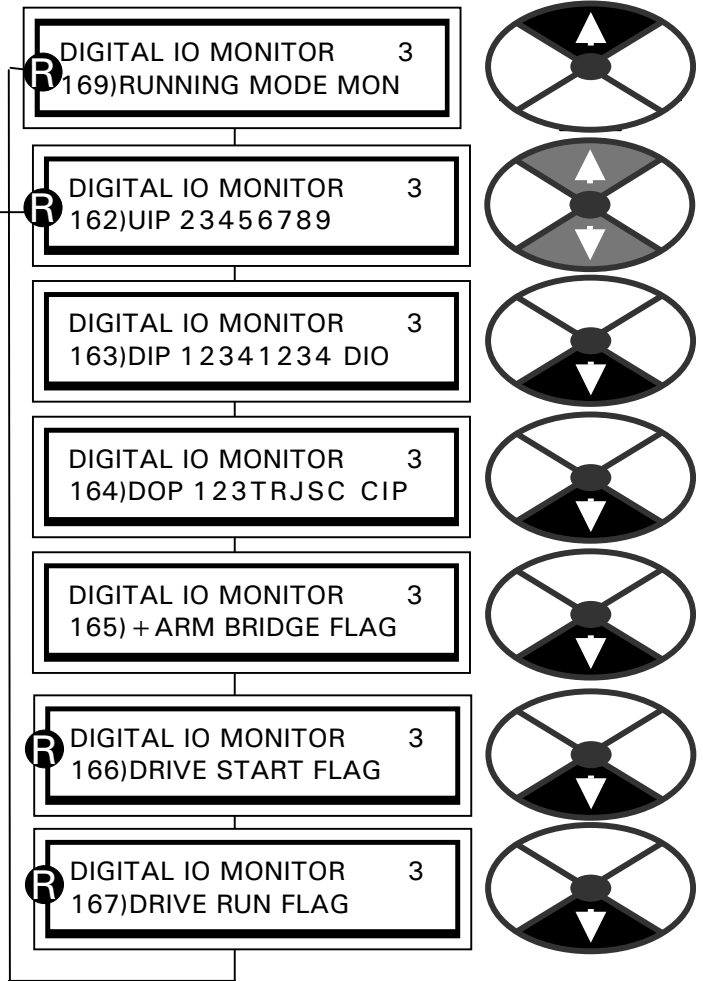
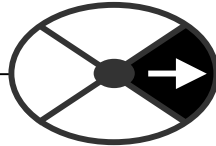

This menu allows monitoring of the digital input and output functions.

Universal inputs are UIP2 to UIP9. (UIP1 is used internally and not available on a terminal).

UIP2 to 9 are universal inputs and can be used as digital and/or analogue inputs. The digital logic level always appears in this menu and the analogue value will simultaneously appear in the analogue IO monitor menu.

The logic inputs are arranged in groups and can be viewed together in one window.

#### 7.5.1 DIGITAL IO MONITOR / UIP2 to 9 digital input monitor PIN 162

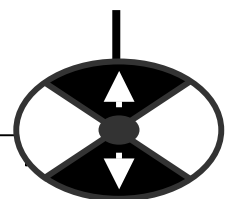
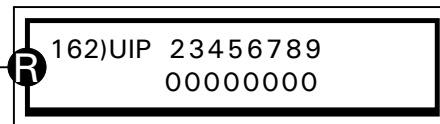
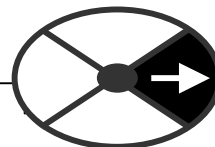

Shows the digital logic level for UIP2 to 9. Set the logic threshold in the config menu.

PARAMETER	RANGE	PIN
UIP 23456789	0/1 for each UIP (0 = low)	162

Note. If this value is connected to another PIN then the pure binary to decimal equivalent is used. (Most significant bit on the right, least significant on the left).

#### 7.5.2 DIGITAL IO MONITOR / DIP1 to 4 and DIO1 to 4 digital input monitor PIN 163

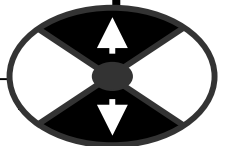
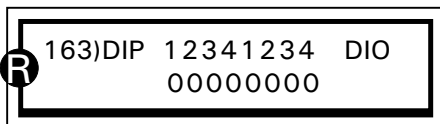
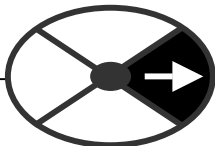

Shows the digital logic level present at the DIP1-4 and DIO1-4 terminals.

PARAMETER	RANGE	PIN
DIP 12341234 DIO	0/1 for each IP (0 = low)	163

Note. If this value is connected to another PIN then the pure binary to decimal equivalent is used. (Most significant bit on the right, least significant on the left).

7.5.3 DIGITAL IO MONITOR / DOP1 to 3 + Control IPs digital monitor PIN 164

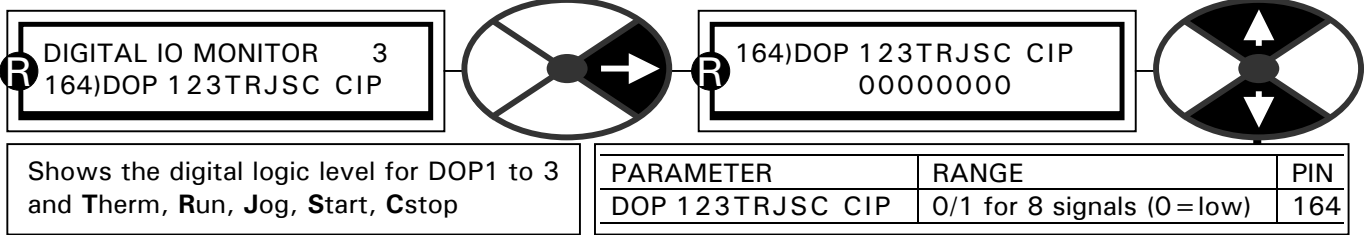

Shows the digital logic level for DOP1 to 3 and Therm, Run, Jog, Start, Cstop

Note. The DOP value shown is the intended value. If the DOP is shorted, a 1 still shows as a 1. Note. If this value is connected to another PIN then the pure binary to decimal equivalent is used. (Most significant bit on the right, least significant on the left).

7.5.4 DIGITAL IO MONITOR / + Armature bridge flag PIN 165

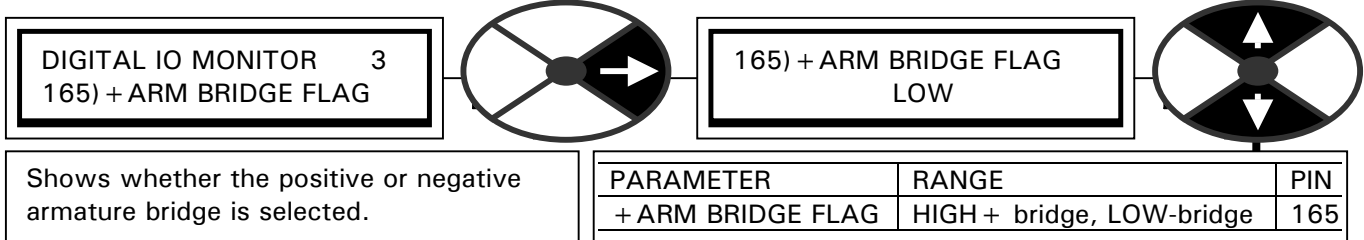

Shows whether the positive or negative armature bridge is selected.

7.5.5 DIGITAL IO MONITOR / Drive start flag PIN 166

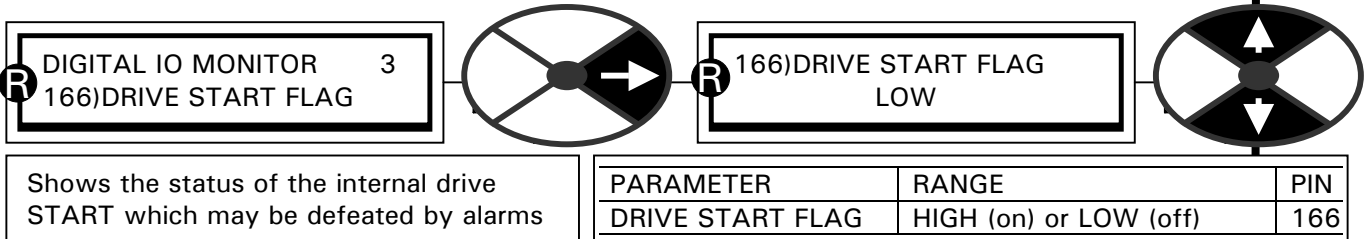

Shows the status of the internal drive START which may be defeated by alarms

7.5.6 DIGITAL IO MONITOR / Drive run flag PIN 167

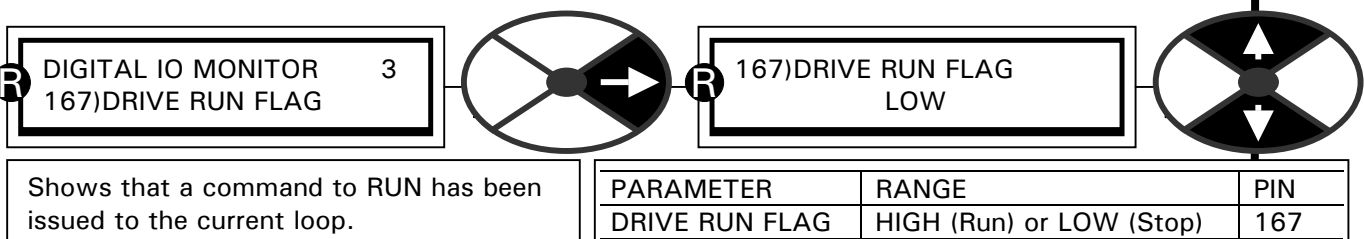

Shows that a command to RUN has been issued to the current loop.

7.5.7 DIGITAL IO MONITOR / Internal running mode monitor PIN 168

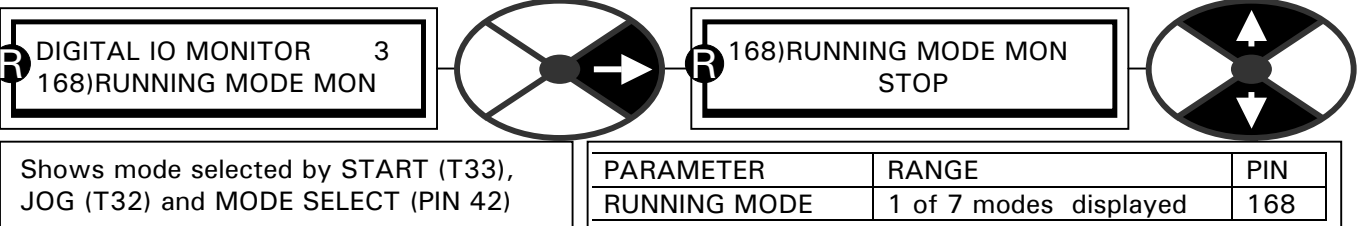

Shows mode selected by START (T33), JOG (T32) and MODE SELECT (PIN 42)

Note. MODE SELECT (PIN42) has a default connection from T15. The 7 modes (with their numeric codes) displayed are (0 or 1) STOP (4) JOG SPEED 1 (5) JOG SPEED 2 (2) RUN (6) SLACK SPEED 1 (7) SLACK SPEED 2 (3) CRAWL



7.6.1 BLOCK OP MONITOR / General description

The majority of the functional blocks within the system are also provided with an output monitor in the block menu listing. It is normally the first window. The outputs are contained in each block listing because it is convenient to have the output monitor adjacent to the relevant adjustment parameters when programming.

In addition all the block outputs are grouped together in this menu for rapid sequential access if required. The block output monitor order is the same as the order of the blocks in the BLOCK OP CONFIG configuration menu. See 13.11 CONFIGURATION / BLOCK OP CONFIG.

7.7 DIAGNOSTICS / EL1/2/3 RMS MON PIN 169

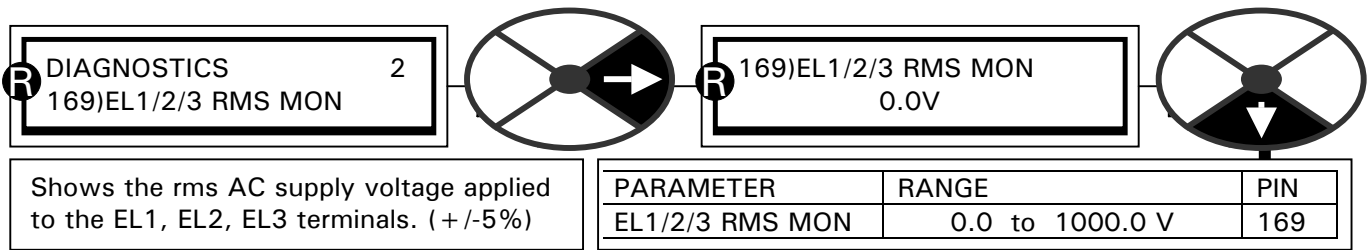

Note. With no applied voltage there may be a small offset. This does not affect the actual reading.

7.8 DIAGNOSTICS / DC KILOWATTS MON PIN 170

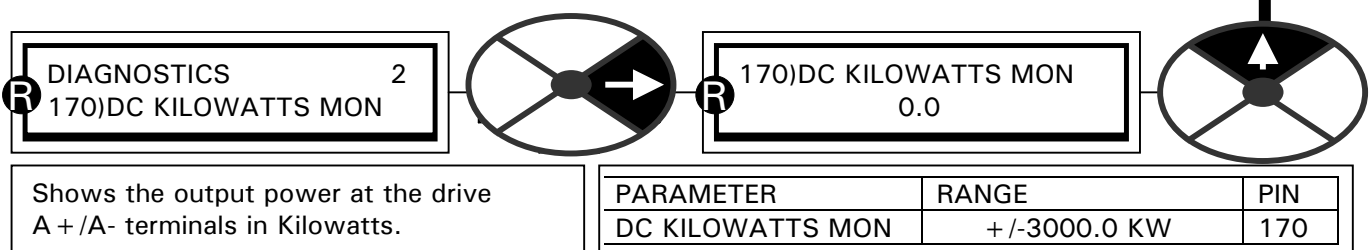

Note. A negative output power shows that the PL/X is regenerating into the AC supply. The power available at the motor shaft will depend on the motor efficiency. (Typically 90 to 95%). To convert Kilowatts to Horsepower multiply by a scaling factor of 1.34.

## 8 MOTOR DRIVE ALARMS

<b>8</b>	<b>MOTOR DRIVE ALARMS .....</b>	<b>135</b>
8.1	MOTOR DRIVE ALARMS menu.....	136
8.1.1	MOTOR DRIVE ALARMS / Speed feedback mismatch trip enable PIN 171 .....	137
8.1.2	MOTOR DRIVE ALARMS / Speed feedback mismatch tolerance PIN 172 .....	139
8.1.3	MOTOR DRIVE ALARMS / Field loss trip enable PIN 173 .....	139
8.1.4	MOTOR DRIVE ALARMS / Digital OP short circuit trip enable PIN 174.....	139
8.1.5	MOTOR DRIVE ALARMS / Missing pulse trip enable PIN 175 .....	140
8.1.6	MOTOR DRIVE ALARMS / Reference exchange trip enable PIN 176 .....	140
8.1.7	MOTOR DRIVE ALARMS / Overspeed delay time PIN 177 .....	140
8.1.8	MOTOR DRIVE ALARMS / STALL TRIP MENU .....	141
8.1.9	MOTOR DRIVE ALARMS / Active and stored trip monitors PINS 181 / 182.....	142
8.1.10	MOTOR DRIVE ALARMS / External trip reset enable PIN 183 .....	143
8.1.11	MOTOR DRIVE ALARMS / DRIVE TRIP MESSAGE .....	143

### 8.1 MOTOR DRIVE ALARMS menu

PIN number range 171 to 183

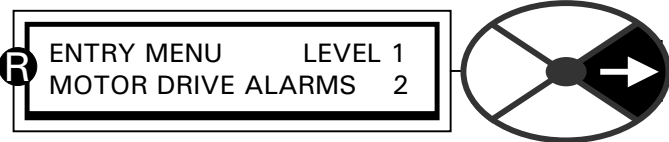

**WARNING. All these alarms are generated with semiconductor electronics. Local safety codes may mandate electro-mechanical alarm systems. All alarms must be tested in the final application prior to use. The manufacturers and suppliers of the PL/X are not responsible for system safety.**

There are 16 alarms that continuously monitor important parameters of the motor drive system. 10 of the alarms are permanently enabled and 6 of the alarms can be enabled or disabled using this menu. It also monitors the alarm status.

If any enabled alarm is triggered it is then latched causing the drive to shut down and the main contactor to be de-energised.

If the alarm has been disabled then it will not be latched and will not affect the operation of the drive, although it can still be monitored.

**If 171)SPEED TRIP ENABLE is disabled, then an automatic switch to AVF is implemented for tacho and/or encoder feedback.**

There are 3 monitoring functions for all 16 alarms.  
 1) An active monitor prior to the latch  
 2) A monitor of the latched status of the alarm.  
 3) A displayed message showing which alarm caused the drive to shut down. The displayed message will automatically appear whenever the drive is running, and can be removed from the display by tapping the left key or starting the drive. It may be re-examined using the DRIVE TRIP MESSAGE menu. **The message will be memorised if the control supply is removed.**

The PL/X alarms have a delay timer associated with them such that they only become latched if the fault condition persists for the whole of the delay period.

Values of this delay period are given for the individual alarms. The quoted times are typical since the delay is implemented in microprocessor "cycle time" units which vary with microprocessor loading. The arrival of the alarms prior to the trigger can be accessed for advance warning purposes using the active monitor window. There is a USER ALARM on hidden PIN 712. This may be connected by the user to any flag, to trip the drive.

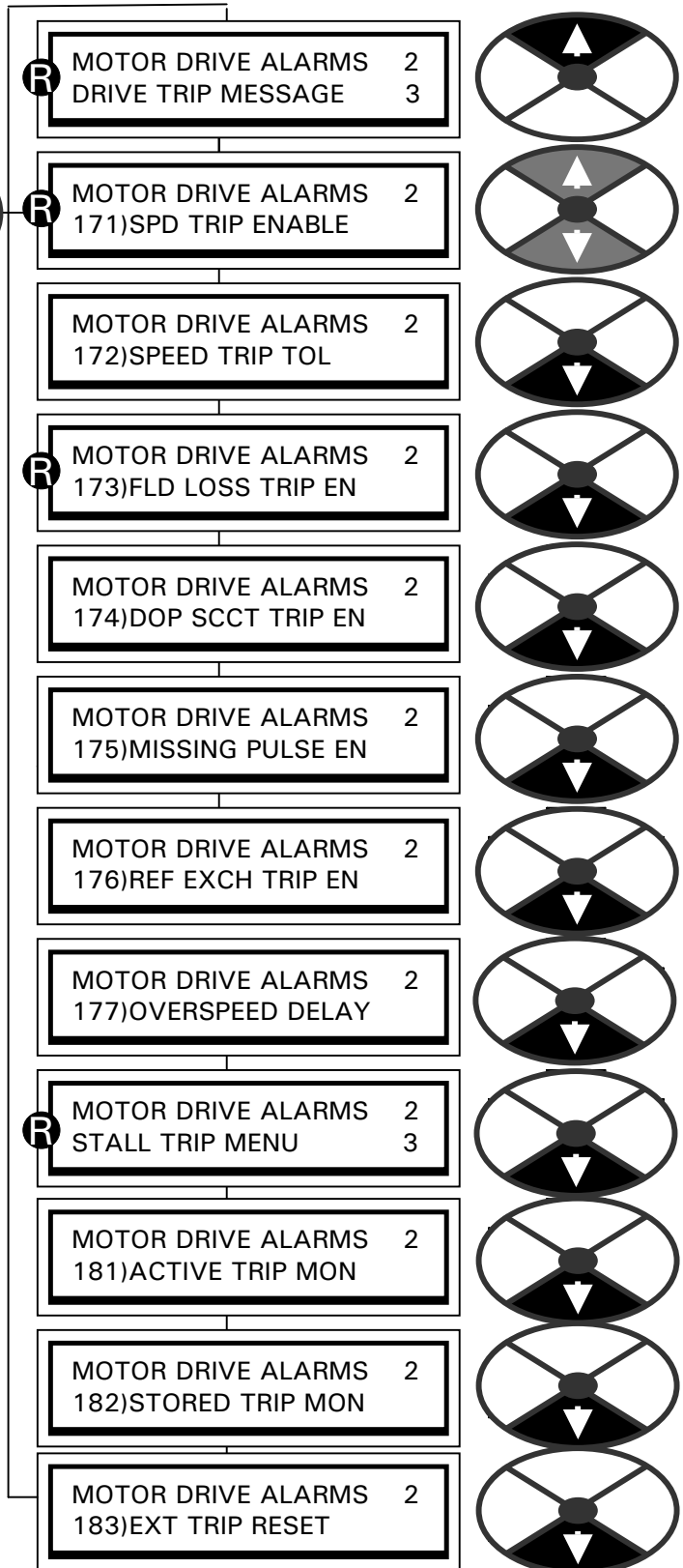



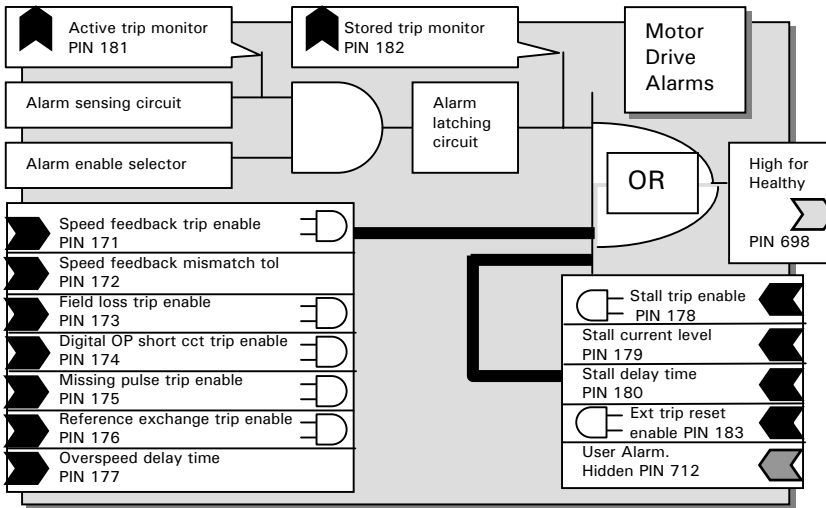

If an alarm is enabled, triggered and latched causing the drive to shut down, then after approximately a further 10ms no further alarms will be latched. Hence when the latched status of the alarms is monitored it is unlikely that more than 1 alarm will be latched. If however more than 1 is latched, then the first that arrived and initiated the shutdown can be determined from the DRIVE TRIP MESSAGE menu.

8.1.1 MOTOR DRIVE ALARMS / Speed feedback mismatch trip enable PIN 171

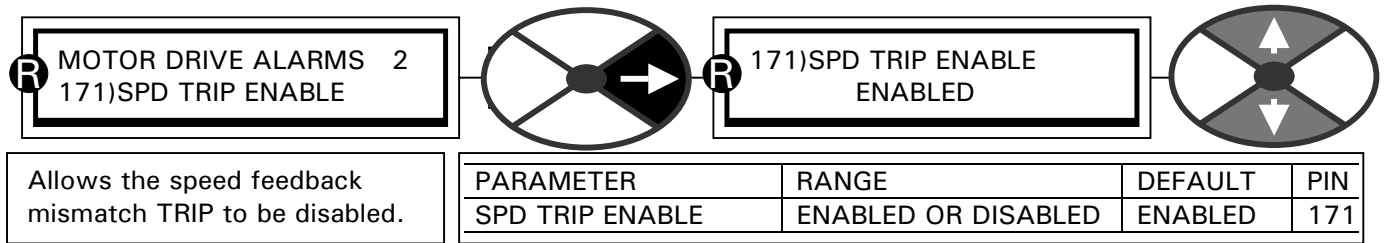

Allows the speed feedback mismatch TRIP to be disabled.

Feedback type	Fault mode	Result if trip ENABLED	Result if trip DISABLED
Armature Voltage	No faults normally possible.	Alarm suppressed	Alarm suppressed
	Armature voltage mode selected with field weakening enabled.	Drive TRIP when field weakening region entered.	Drive TRIP when field weakening region entered.
Tacho OR Encoder	Incorrect polarity and 172)SPEED TRIP TOL set to less than approx. 20%	Drive TRIP	Automatic switch to AVF
	Incorrect polarity and 172)SPEED TRIP TOL set to greater than approx. 20%	Drive TRIP	Drive TRIP
	Feedback loss and 172)SPEED TRIP TOL exceeded	Drive TRIP	Automatic switch to AVF
Tacho OR Encoder With field weakening	Incorrect polarity	Drive TRIP	Drive TRIP
	Total feedback loss (< 10% signal)	Drive TRIP when field weakening region entered.	Drive TRIP when field weakening region entered.
Encoder + Armature Volts OR Encoder + Tacho.  combinational feedback	Partial feedback loss	<b>Protection limited to armature overvolts TRIP at minimum field current</b>	<b>Protection limited to armature overvolts TRIP at minimum field current</b>
	Incorrect encoder and/or tacho polarity and 172)SPEED TRIP TOL set to less than approx. 20%	Drive TRIP	Automatic switch to AVF.
	Incorrect encoder and/or tacho polarity and 172)SPEED TRIP TOL set to greater than approx. 20%	Drive TRIP	Drive TRIP
	Encoder loss and 172)SPEED TRIP TOL exceeded.	Drive TRIP	Automatic switch to AVF. (The speed mismatch may be small because the AVF component is still valid, hence 172)SPEED TRIP TOL must be set low enough to ensure an automatic switch occurs).
Encoder + Armature Volts OR Encoder + Tacho.  Combinational feedback with field weakening	Tacho loss and 172)SPEED TRIP TOL exceeded	Drive TRIP	Automatic switch to AVF
	Incorrect encoder and/or tacho polarity	Drive TRIP	Drive TRIP
	Total encoder and/or tacho loss (< 10% signal)	Drive TRIP when field weakening region entered.	Drive TRIP when field weakening region entered.
	Partial encoder and/or tacho loss	<b>Protection limited to armature overvolts TRIP at minimum field current</b>	<b>Protection limited to armature overvolts TRIP at minimum field current</b>
	Encoder + Armature voltage mode selected with field weakening enabled	Drive TRIP when field weakening region entered.	Drive TRIP when field weakening region entered.

A continuous comparison is made by the controller of the speed feedback and armature voltage feedback. If the difference is greater than the value set by 8.1.2 MOTOR DRIVE ALARMS / Speed feedback mismatch tolerance PIN 172, the alarm is operated. If armature voltage feedback is selected, then the speed feedback alarm is automatically suppressed.

If 103)FLD WEAK ENABLE is enabled, then the controller suspends the speed-to-volts comparison in the field-weakening region where the volts are clamped to a maximum value. Instead, when in the field-weakening region it checks whether the speed feedback is below 10% of full speed. If so, the alarm will operate. This means that it is not practical to start field weakening below 10% of full speed i.e. 10 : 1 range.

The automatic switch to AVF feature allows continued running, although at the lower accuracy level of Armature Voltage feedback. The AVF remains the source of feedback until the next STOP / START sequence. The original feedback source is then restored and the alarm reset to allow auto AVF protection once again. It may be necessary to reduce the 172)SPEED TRIP TOL to about 15% if a smooth transfer to auto AVF is required. However, if the threshold is too low then an unwarranted transfer may occur during speed transients.

There is a flag on hidden PIN 703 which warns of a speed mismatch after the normal delay time. This flag is reset by a STOP command. It is suggested that the flag is configured to a digital output to provide a warning that the auto AVF has occurred.

The speed feedback mismatch alarm is normally triggered by failure of the feedback mechanism in one of the following ways:-

- 1) Disconnection of wiring.
- 2) Failure of the tachogenerator or encoder.
- 3) Failure of the tachogenerator or encoder mechanical coupling.

Note. Alarm delay time: 0.4 secs to TRIP, 0.2 secs to automatic AVF switch.

**WARNING. The protection afforded in field weakening mode is limited to total feedback loss only. This is because the speed / AVF relationship is not maintained in field weakening mode. If a partial loss of feedback occurs the motor will run to excessive speed. When the field has been completely weakened and is at its minimum level, the armature overvoltage trip will come into operation. This may only occur at a dangerous speed. It is therefore recommended that a mechanical device be utilised to protect against this possibility.**

Correct setting of 110)MIN FIELD CURRENT should ensure that the overvolts TRIP occurs just above the maximum operating speed.

8.1.2 MOTOR DRIVE ALARMS / Speed feedback mismatch tolerance PIN 172

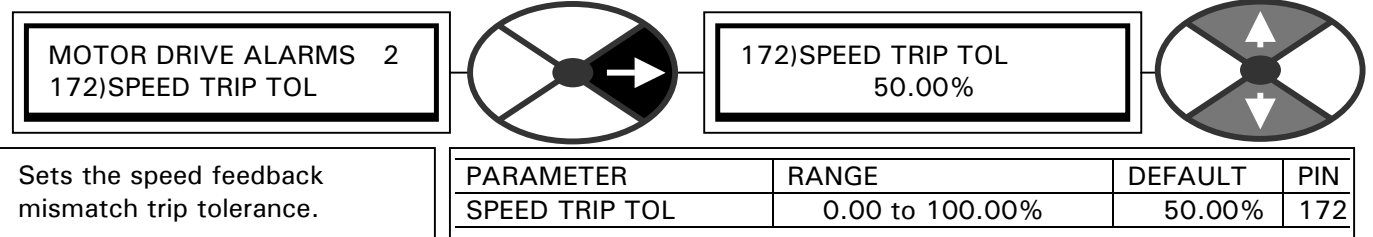

Sets the speed feedback mismatch trip tolerance.

Note. If this value is set too low then spurious alarms may be caused by dynamic lags or non-linear effects. Note. Mismatched calibration between the AVF and tacho and/or encoder calibration erodes this margin.

Note. There is a flag on hidden PIN 703 which warns of a speed mismatch after the normal delay time. This flag is reset by a start or jog command.

8.1.3 MOTOR DRIVE ALARMS / Field loss trip enable PIN 173

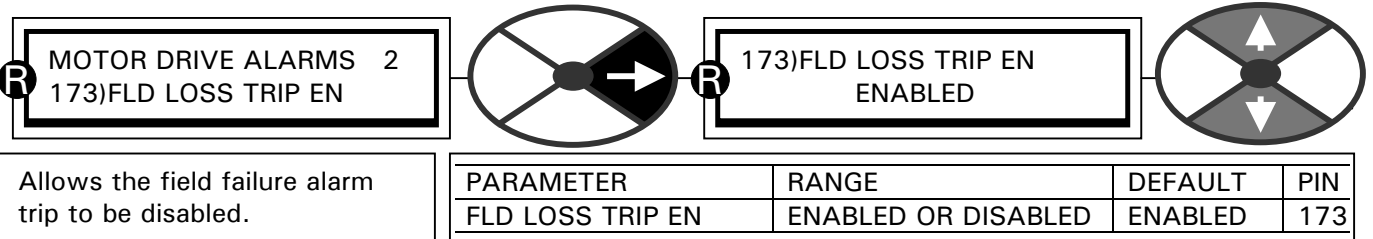

Allows the field failure alarm trip to be disabled.

This alarm will normally trigger if the field current drops below 20% of rated current (5% in field weakening mode). Faulty operation of the field controller may also cause a motor field fail alarm. The most usual cause for the motor field alarm is an open circuit motor field.

If this alarm occurs, the motor field connections should be checked and the field resistance measured. The resistance of the field = dataplate field volts / dataplate field current.

**WARNING.** For rated field currents that are less than 25% of model rating the alarm threshold may be too low to trigger. The alarm must be tested. To overcome this problem, 4)RATED FIELD AMPS may be set to a higher level and 114)FIELD REFERENCE set lower. This has the effect of raising the threshold. E.g. Set 4)RATED FIELD AMPS to twice motor rating and 114)FIELD REFERENCE to 50.00%.

If the PL/X is feeding a load which requires no field supply, for example a permanent magnet motor, then 99)FIELD ENABLE should be disabled. This automatically inhibits the field fail alarm.

Alarm delay time: 2.00 secs.

8.1.4 MOTOR DRIVE ALARMS / Digital OP short circuit trip enable PIN 174

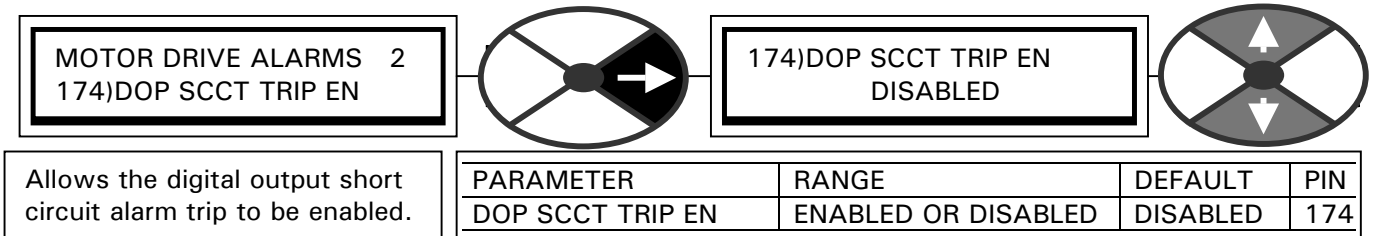

Allows the digital output short circuit alarm trip to be enabled.

All digital outputs, and the 24V user supply have been designed to withstand a direct short circuit to 0V. If this happens, an internal alarm is raised. The remaining digital outputs are also disabled resulting in a low output. (Short circuit current is approximately 350mA for digital outputs and 400mA for +24V).

If the alarm is disabled and the shorting fault has not interrupted the drive running normally, then the drive will continue to run. Note, if any digital output is shorted the +24V terminal T35 will remain active with a capability of 50mA. If the +24V output is shorted then all digital outputs will also go low and this alarm is activated. In this case if the +24V is being used to enable CSTOP or START then the drive will stop.

8.1.5 MOTOR DRIVE ALARMS / Missing pulse trip enable PIN 175

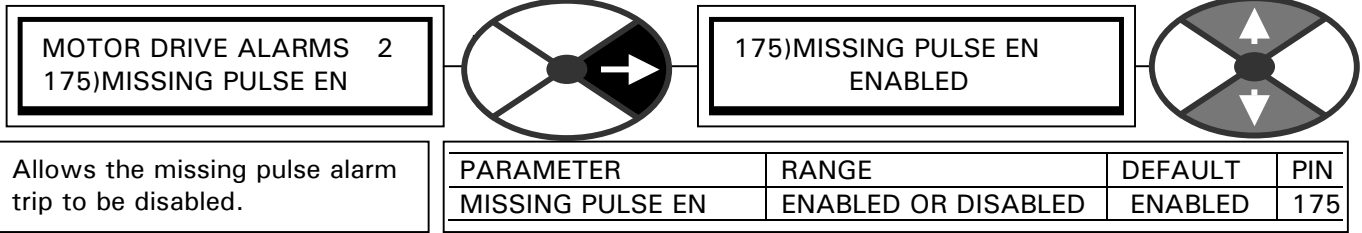

The controller continuously monitors the armature current waveform. If a fault develops within the controller or the armature bridge, it is possible that one or more pulses may be missing from the normal 6-pulse armature current waveform. Although the controller may appear to function normally, the motor will experience excess heating due to the distorted current waveform.

If at least one of the 6 current pulses is missing from the feedback waveform and the current demand is above 10% then the system will start counting missing pulses. The alarm will trigger after a sequential series of missing pulses lasting approximately 30 seconds.

The most usual causes of missing pulse failure is either an open circuit main fuse, or a gate lead plug not properly re-connected after a stack maintenance procedure. Alarm delay time: approx 30 secs.

8.1.6 MOTOR DRIVE ALARMS / Reference exchange trip enable PIN 176

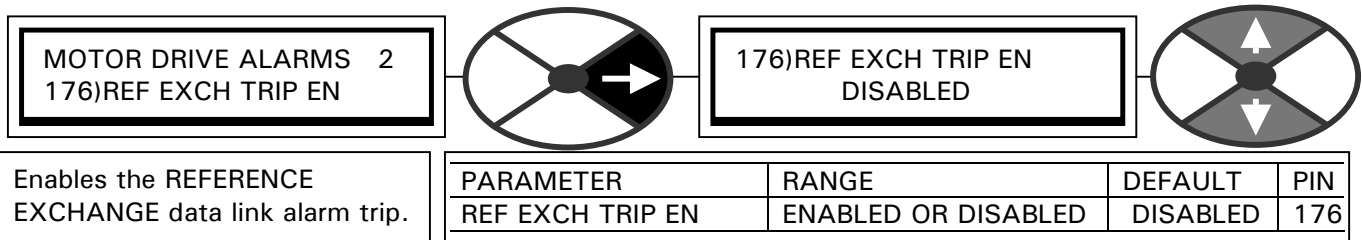

The drive can transmit and receive a speed reference or other parameter to or from another controller using the serial port. During the receive cycle it checks that the data received is valid. If the data is invalid then it raises an alarm. This is only applicable in the SLAVE mode of operation. See 10.3 RS232 PORT1 / PORT1 REF EXCHANGE The alarm flag is available on hidden PIN 701.

Alarm delay time: 1.5 secs.

8.1.7 MOTOR DRIVE ALARMS / Overspeed delay time PIN 177

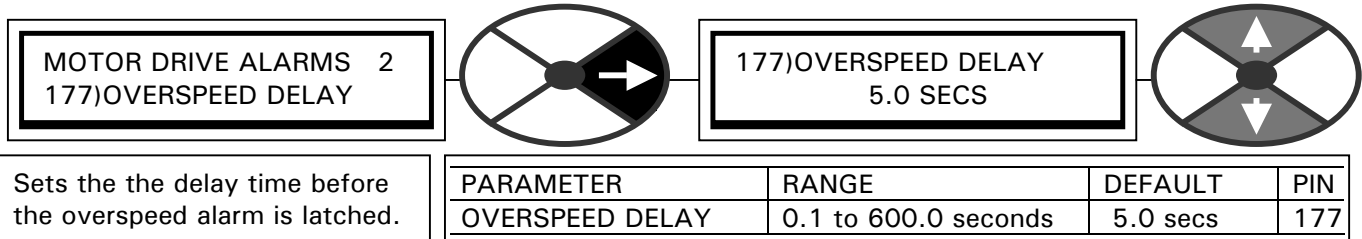

See 8.1.11.7 DRIVE TRIP MESSAGE / Overspeed.

8.1.8 MOTOR DRIVE ALARMS / STALL TRIP MENU



See also 6.8.3.1.2 How to get overloads greater than 150% using 82)O/LOAD % TARGET.

In this case 179)STALL CUR LEVEL must be set below 82)O/LOAD % TARGET for stall protection.

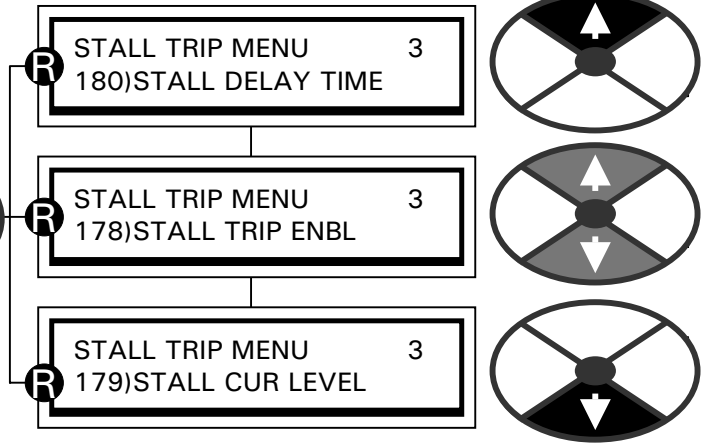

8.1.8.1 STALL TRIP MENU / Stall trip enable PIN 178



Allows the motor stall alarm trip to be enabled.

PARAMETER	RANGE	DEFAULT	PIN
STALL TRIP ENBL	ENABLED OR DISABLED	ENABLED	178

A DC motor is generally not capable of carrying large amounts of current when stationary. If the current exceeds a certain limit and the motor is stationary, then the PL/X controller can provide a stall trip alarm.

If 178)STALL TRIP ENBL is enabled, the current is above 179)STALL CUR LEVEL, and the motor is at zero speed (below ZERO INTERLOCKS / 117)ZERO INTLK SPD %) for longer than 180)STALL DELAY TIME, then the alarm is activated.

**WARNING.** When using armature voltage feedback the IR drop may be sufficient to provide a signal in excess of 117)ZERO INTLK SPD % and hence the stall alarm will not operate. Set 14)IR COMPENSATION as accurately as possible, and then test the alarm with a stalled motor. (Disable the field). Progressively increase current limit to above the 179)STALL CUR LEVEL, to check that the AV speed feedback remains below 117)ZERO INTLK SPD %. It may be necessary to increase 117)ZERO INTLK SPD % to ensure tripping.

8.1.8.2 STALL TRIP MENU / Stall current level PIN 179

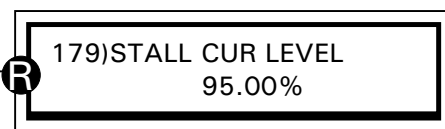

Sets the stall alarm trip LEVEL as a % of rated motor amps.

PARAMETER	RANGE	DEFAULT	PIN
STALL CUR LEVEL	0.00 to 150.00%	95.00%	179

See 6.8.3.1.2 How to get overloads greater than 150% using 82)O/LOAD % TARGET.

8.1.8.3 STALL TRIP MENU / Stall time PIN 180



Sets the delay time between stall start and alarm trigger.

PARAMETER	RANGE	DEFAULT	PIN
STALL DELAY TIME	0.1 to 600.0 seconds	10.00 secs	180

8.1.9 MOTOR DRIVE ALARMS / Active and stored trip monitors PINS 181 / 182

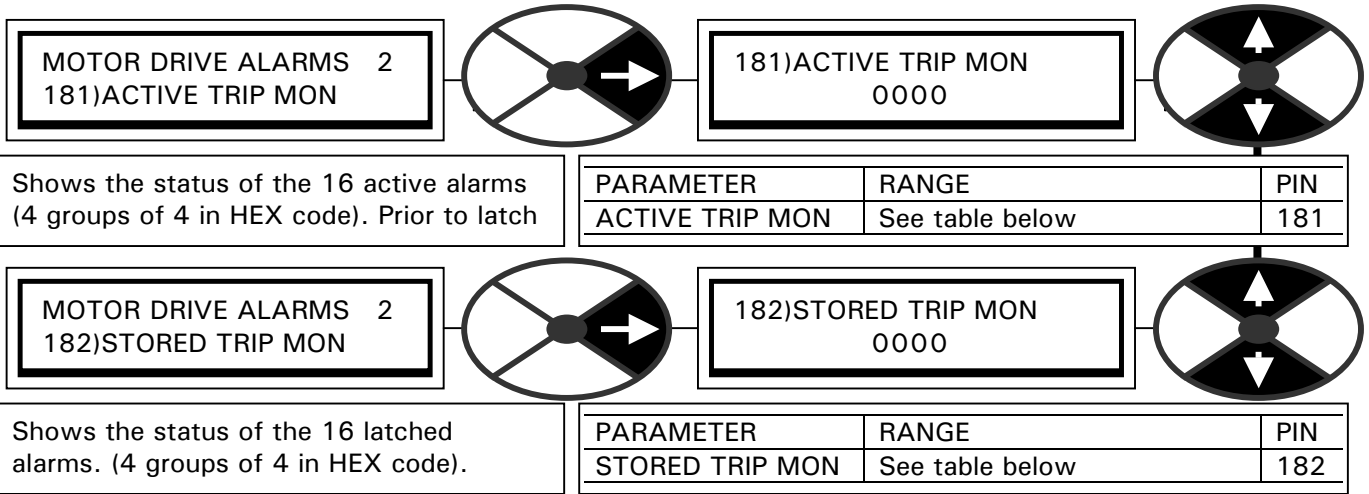

Branch hopping facility between these two windows.

The 4 characters in the window are hex codes. The table below shows how to decode them to binary logic. The codes 0, 1, 2, 4, 8 are the most likely. The others only occur with 2 or more alarms high in any group.

HEX CODE	BINARY
0	0000
1	0001
2	0010
3	0011
4	0100
5	0101
6	0110
7	0111

HEX CODE	BINARY
8	1000
9	1001
A	1010
B	1011
C	1100
D	1101
E	1110
F	1111

Note. If this value is connected to another PIN then the pure hexadecimal to decimal equivalent is used. (Most significant character on the right, least significant on the left).

You can decode the HEX into 16 flags from right to left in 4 groups of 4 using the above table as an aid.

Example. 0005 shows ARMATURE OVERCURRENT and OVERSPEED.  
Example. 0060 shows MISSING PULSE and FIELD LOSS

- List of motor alarms
- ARMATURE OVERCURRENT
- SPEED FBK MISMATCH
- OVERSPEED
- ARMATURE OVER VOLTS

- FIELD OVERCURRENT
- FIELD LOSS
- MISSING PULSE
- STALL TRIP

- THERMISTOR ON T30
- HEATSINK OVERTEMP
- SHORT CCT DIG OP
- BAD REFERENCE EXCH

- CONTACTOR LOCK OUT
- USER ALARM INPUT (PIN 712)
- SYNCHRONIZATION LOSS
- SUPPLY PHASE LOSS

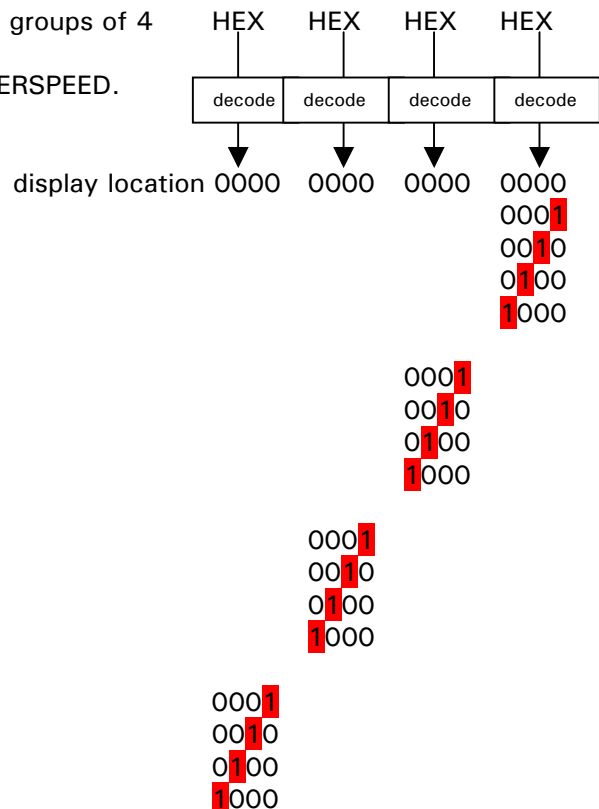

8.1.10 MOTOR DRIVE ALARMS / External trip reset enable PIN 183

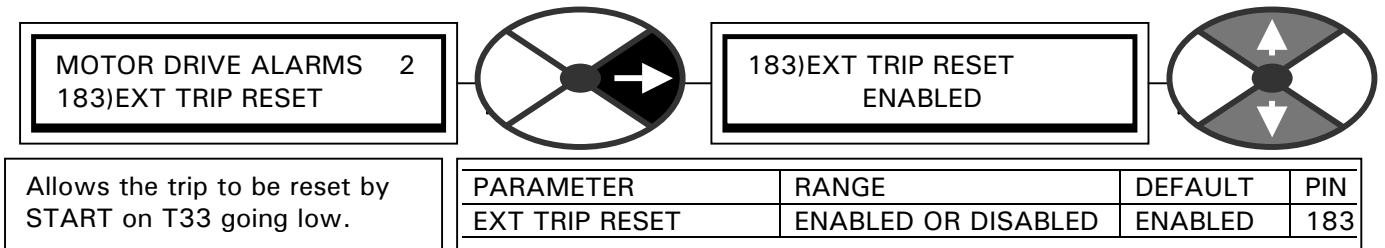

Allows the trip to be reset by START on T33 going low.

When DISABLED will prevent re-starting after a trip. **(DO NOT RELY ON THIS FOR SAFETY).**

8.1.11 MOTOR DRIVE ALARMS / DRIVE TRIP MESSAGE

If an alarm is triggered, a displayed message showing which alarm caused the drive to shut down will automatically appear in the bottom line of the display window, along with !!!!! ALARM !!!!! on the top line. It can be removed from the display by tapping the left key or starting the drive. It may be re-examined using the DRIVE TRIP MESSAGE window. The message will be memorised if the control supply is removed. To remove the message from the memory, go to this window and tap the down key. Note. If when trying to enter the DRIVE TRIP MESSAGE window no alarms have been detected, then the MOTOR DRIVE ALARMS window will show the message NO ALARMS DETECTED and the DRIVE TRIP MESSAGE window is closed.

8.1.11.1 DRIVE TRIP MESSAGE / Armature overcurrent

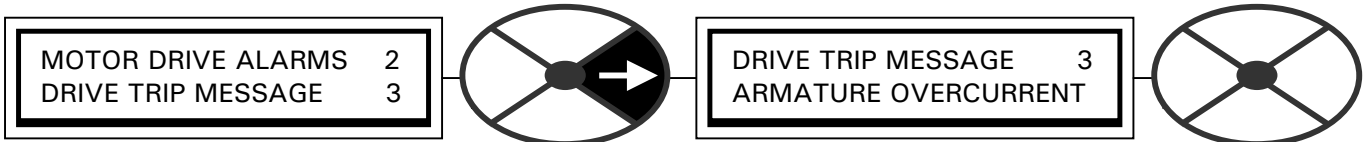

An armature current trip is provided. This is set to operate for current feedback values exceeding 170% of the maximum model current, or 300% of 2)RATED ARM AMPS, whichever is reached first.

Motor Faults: If the motor armature windings fail, the armature impedance may drop sharply. This may cause excessive armature current which will activate the current trip. If this occurs, the motor armature should be checked (Meggered) for insulation resistance, which should be above acceptable limits. **(Disconnect the drive when using a megger).** If the motor becomes completely short-circuited, the current trip will not protect the controller. **High speed semi-conductor thyristor fusing must always be provided to protect the thyristor stack.**

Alarm delay time. Alarm will allow 300% loading for around 10 msecs and 400% for 5 msecs.

8.1.11.2 DRIVE TRIP MESSAGE / Armature overvolts

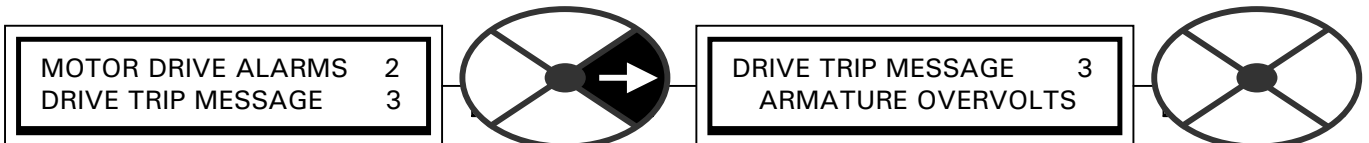

If the motor armature voltage feedback exceeds 18)RATED ARM VOLTS by more than 20% then this alarm will operate. . 18)RATED ARM VOLTS may be lower than the dataplate maximum. This alarm operates with any source of speed feedback.

The alarm can be caused by a badly adjusted field voltage setting, field current loop, field-weakening back emf loop or speed loop overshooting.

Alarm delay time: 1.5 secs.

8.1.11.3 DRIVE TRIP MESSAGE / Field overcurrent

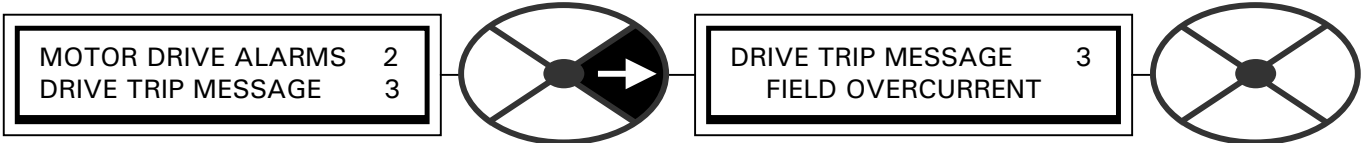

The controller checks that the field current does not exceed 115% of 4)RATED FIELD AMPS.

This alarm could become active due to regulator failure or a badly tuned control loop causing overshoots.

Alarm delay time: 15 secs.

## 8.1.11.4 DRIVE TRIP MESSAGE / Field loss

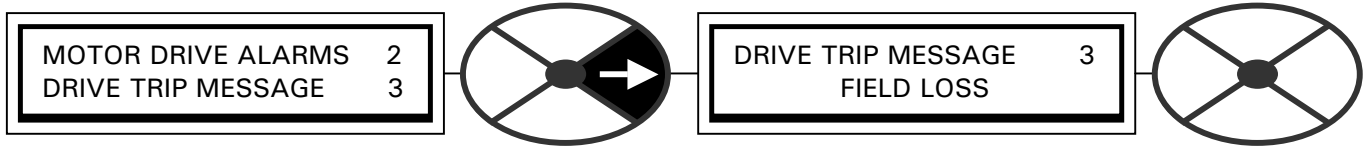

See 8.1.3 MOTOR DRIVE ALARMS / Field loss trip enable PIN 173.

Alarm delay time: 2 secs.

## 8.1.11.5 DRIVE TRIP MESSAGE / User trip

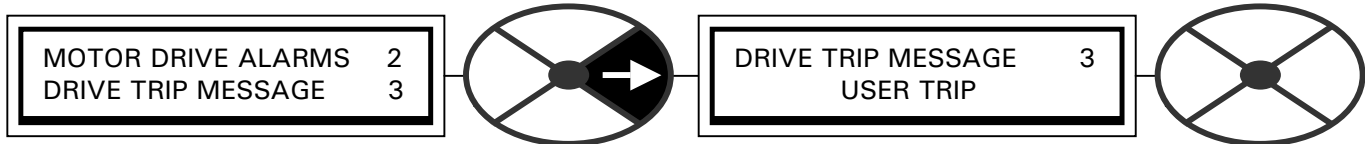

There is a hidden PIN 712 that will cause a trip after going high.

Use a jumper to connect to flag source. See 13.2.4 JUMPER connections. Alarm delay time: 0.5 secs.

## 8.1.11.6 DRIVE TRIP MESSAGE / Thermistor on T30

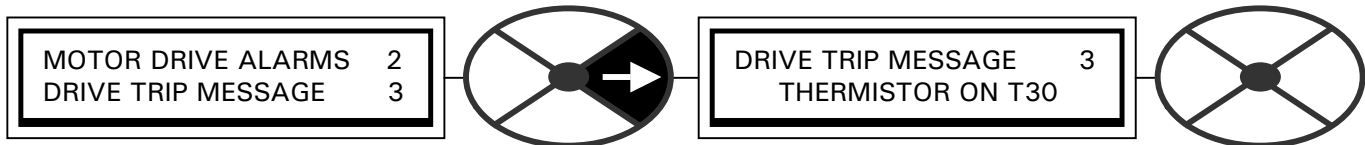

It is good practice to protect DC motors against sustained thermal overloads by fitting temperature sensitive resistors or switches in the field and interpole windings of the machine. Temperature sensitive resistors have a low resistance (typically 200 Ohms) up to a reference temperature (125 deg C). Above this, their resistance rises rapidly to greater than 2000 Ohms.

Temperature switches are usually normally closed, opening at about 105 deg C.

Motor overtemperature sensors should be connected in series between terminals T30 and T36. If the motor temperature rises such that the resistance of the sensor exceeds 1800 Ohms, the thermistor alarm will be activated. If this happens, the motor must be allowed to cool before the alarm can be reset.

Motors overheat due to many factors, but the most common cause is inadequate ventilation. Check for blower failure, wrong rotation of the blower, blocked ventilation slots and clogged air filters. Other causes of overheating relate to excessive armature current. The nominal armature current on the motor nameplate should be checked against the current calibration for the PL/X.

There is no motor temperature alarm inhibit; terminals T30 and T36 must be linked if over-temperature sensors are not used.

Note. There is a flag on hidden PIN 702 which warns of thermistor over-temp after the normal delay time.

This flag is reset by a start or jog command.

Alarm delay time: 15 secs.

## 8.1.11.7 DRIVE TRIP MESSAGE / Overspeed

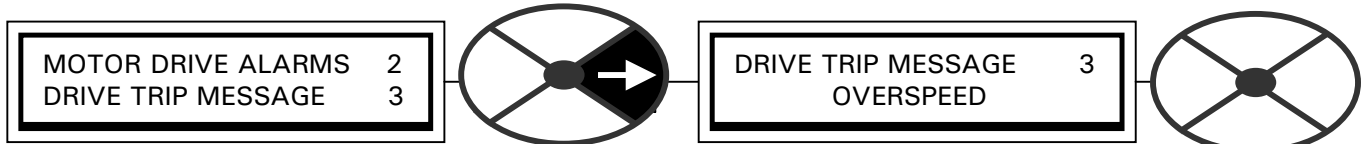

If the speed feedback signal exceeds 110% of rated speed for longer than the alarm delay time, then the overspeed alarm is activated. This alarm is likely to be caused by a badly adjusted speed loop or overhauling of motors controlled by 2 Quadrant models.

Alarm delay time: 0.5 secs. + (8.1.7 MOTOR DRIVE ALARMS / Overspeed delay time PIN 177).



8.1.11.8 DRIVE TRIP MESSAGE / Speed feedback mismatch

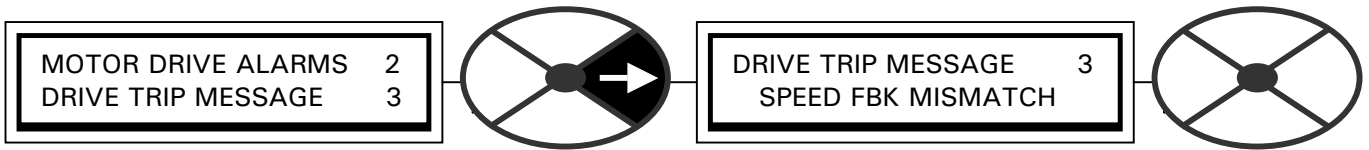

See 8.1.1 MOTOR DRIVE ALARMS / Speed feedback mismatch trip enable PIN 171.  
 This message will also appear if a trip is caused by trying to field weaken with AVF feedback.

8.1.11.9 DRIVE TRIP MESSAGE / Stall trip

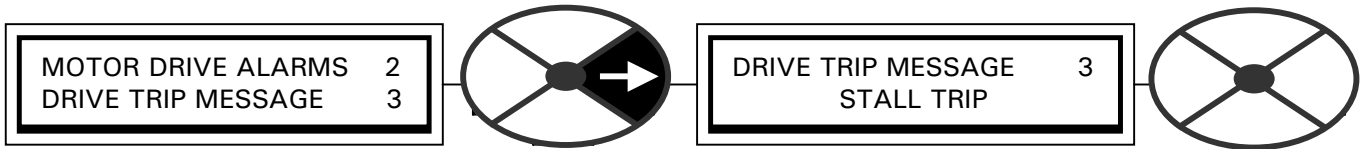

See 8.1.8.1 STALL TRIP MENU / Stall trip enable PIN 178.

8.1.11.10 DRIVE TRIP MESSAGE / Missing pulse

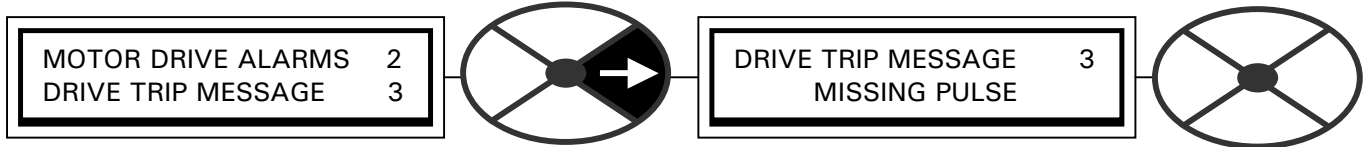

See 8.1.5 MOTOR DRIVE ALARMS / Missing pulse trip enable PIN 175.

8.1.11.11 DRIVE TRIP MESSAGE / Supply phase loss

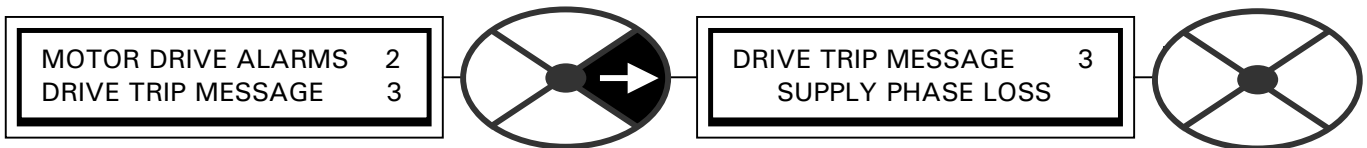

The controller continuously monitors the incoming supply of the EL1, EL2 connections. If either are lost, the alarm will operate. The subsequent control action depends on the running condition at the time the alarm is triggered. The message will also briefly appear after the control supply has been removed.

- 1) If the main contactor is energised at the time of failure then it will be de-energised after the ride through time of 2 seconds has elapsed. If the supply is restored before the ride through time has elapsed then normal running will resume. During the temporary supply loss period the PL/X will shut the armature current demand off until it is safe to restore it. The unit measures the back emf to calculate a safe start into the rotating load.
- 2) If the main contactor is de-energised at the time of the supply loss then a Start command will allow the contactor to energise but inhibit armature current. After a few seconds the contactor will be de-energised.

The Control Supply on T52, T53 can tolerate a supply loss for 300mS at 240V AC, and 30mS at 110V AC, before requesting permanent shut down.

See also 6.1.16 CALIBRATION / EL1/2/3 rated AC volts PIN 19 QUICK START.

The controller will detect total failure of the supply. A missing phase is detected under most circumstances. However, the controller may be connected to the same supply as other equipment that is regenerating a voltage onto the supply lines during the missing phase period. Under these circumstances, the SUPPLY PHASE LOSS alarm may be unable to detect failure of the incoming supply, and hence not operate.

In the case of a supply phase loss alarm, the supply to the controller should be checked.  
 The auxiliary and the main high speed semi-conductor fuses, should be checked.

See also 3.6 Supply loss shutdown.

The supply is monitored on EL1/2. This allows AC supply or DC outgoing main contactors to be used.  
 Alarm delay time 2.0 secs.

8.1.11.12 DRIVE TRIP MESSAGE / Synchronization loss

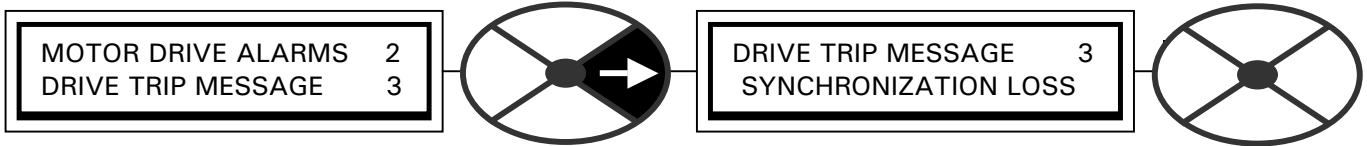

The PL/X controller automatically "locks on" to any 3-phase supply within a frequency range of 45 to 65 Hertz. This allows the thyristors to be fired at the correct instant during each supply cycle. The synchronisation circuit can cope with a large level of supply distortion to ensure operation with very distorted supplies. The lock on time is 0.75 seconds. If the standard wiring configuration is adopted with EL1/2/3 permanently energised then the phase lock will only need to lock on during the first application of power. This allows the main contactor to be operated very rapidly with minimal start up delay if required.

Wiring configurations that involve application of the auxiliary supply coincident with a start requirement will have 0.75 second delay prior to main contactor energisation.

If the supply frequency exceeds the min/max limits, or if the controller is supplied from a power supply which has excessive distortion this may cause synchronisation errors and the alarm to operate.

Note. This alarm will operate during running. If there is failure to achieve synchronisation at start, then the alarm CONTACTOR LOCK OUT is displayed. See 8.1.11.18 DRIVE TRIP MESSAGE / Contactor lock out.

Alarm delay time: 0.5 secs.

8.1.11.13 DRIVE TRIP MESSAGE / Heatsink overtemp

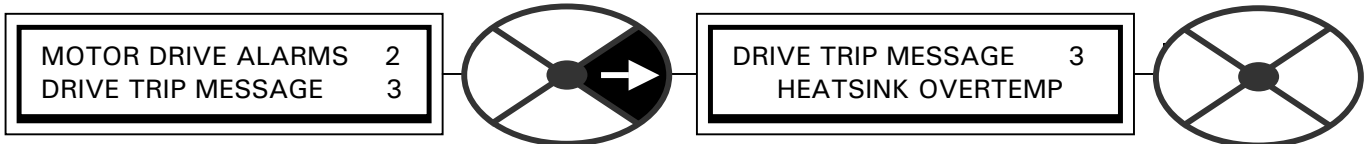

In the event of blower failure, or restriction of the cooling airflow, the heatsink temperature may rise to an unacceptable level. Under these conditions, the heatsink overtemp alarm will operate.

If this alarm operates on units fitted with a heatsink blower, it should be checked for obstruction and the cooling air path checked for obstructions. Models fitted with twin top mounted fans are provided with fan stall protection. Once the obstruction is removed the fan should resume normal operation. If the fan does not run, the fan assembly must be replaced. For units with an AC driven rear mounted fan (PL/X 185/225/265) check that the 110V AC fan supply is present on terminals B1, B2.

The unit enclosure must be supplied with sufficient cool dry clean air. See 14.1 Product rating table. The unit must be allowed to cool in order to re-start. Alarm delay time: 0.75 secs

8.1.11.14 DRIVE TRIP MESSAGE / Short circuit digital outputs

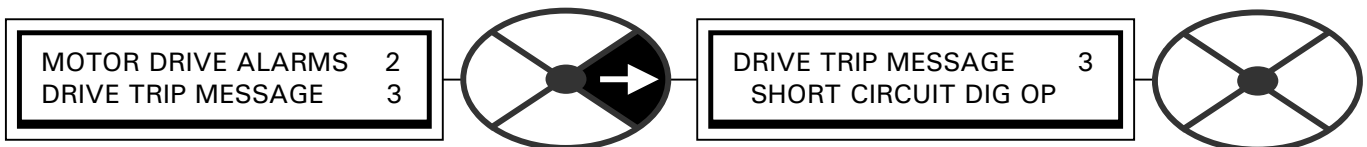

See 8.1.4 MOTOR DRIVE ALARMS / Digital OP short circuit trip enable PIN 174.

8.1.11.15 DRIVE TRIP MESSAGE / Bad reference exchange

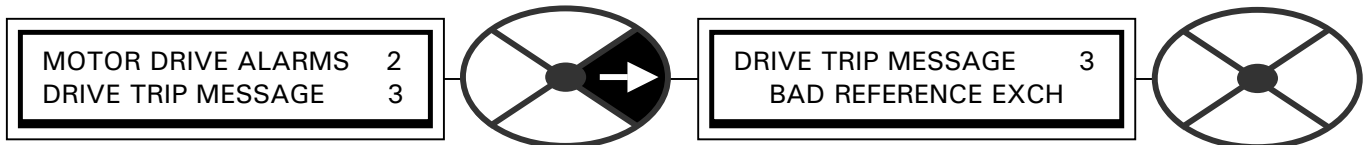

See 8.1.6 MOTOR DRIVE ALARMS / Reference exchange trip enable PIN 176.

Note. There is a flag on hidden PIN 701 which warns of a bad reference exchange. This flag is reset by a start or jog command.

8.1.11.16 DRIVE TRIP MESSAGE / Cannot autotune

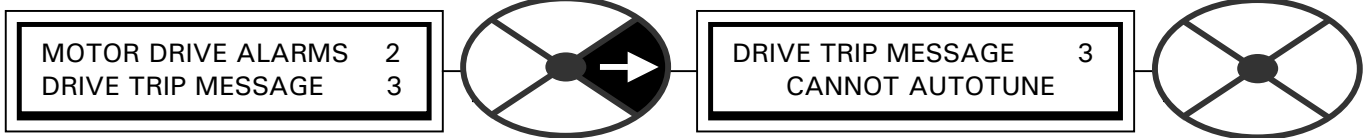

During autotune the drive turns off the field to prevent shaft rotation. An "autotune error" will be triggered by speed feedback being > 20% of rated speed or field current feedback being > 5 % of rated field current during the autotune activity.

Note. Speed feedback being > 20% may be caused by residual field magnetisation resulting in shaft rotation. If so, retry the Autotune with the motor shaft mechanically locked.

8.1.11.17 DRIVE TRIP MESSAGE / Autotune quit

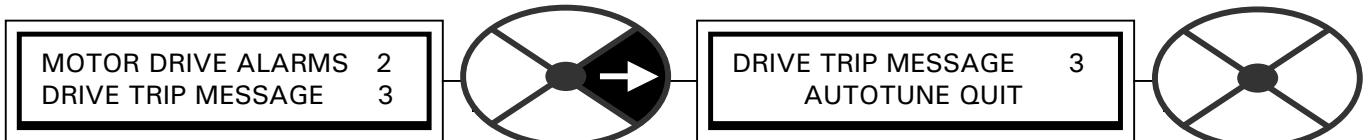

The controller will quit the autotune function if the coast stop, start or run terminals are disabled (taken low) Alternatively, if the autotune ENABLE/DISABLE is instructed to be DISABLED during its autotune sequence then this message will appear. See 6.8.9 CURRENT CONTROL / Autotune enable PIN 92. A time-out ( approx. 2 mins) will also cause an autotune quit.

8.1.11.18 DRIVE TRIP MESSAGE / Contactor lock out

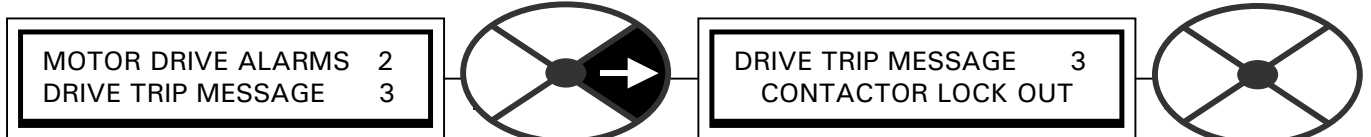

This alarm may be caused by two possible events at the commencement of a running mode request. It is accompanied by automatic inhibiting of the current loop followed by de-energisation of the contactor.

- 1) If the incoming 3 phase supply is of insufficient quality to allow the synchronisation circuit to measure its frequency and/or phase rotation. It may be due to an intermittent or missing phase on EL1/2/3.
- 2) The ZERO REFERENCE interlock function has been enabled and the operator has failed to reset the external speed references to zero. See 6.10 CHANGE PARAMETERS / ZERO INTERLOCKS.

8.1.11.19 DRIVE TRIP MESSAGE / Warning flags

Note. The following alarms are also available on hidden PINs after the normal delay time irrespective of whether they are enabled to trip the drive or not. These flags are reset by a start or jog command.

- |                     |                    |
|---------------------|--------------------|
| 700)STALL WARNING   | 701)REF XC WARNING |
| 702)THERMISTOR WARN | 703)SPD FBK WARN   |

There is also one further active flag 704)I LOOP OFF WARN on a hidden PIN which goes low as soon as the current loop stops making current under the following fault conditions.

8.1.11.1 DRIVE TRIP MESSAGE / Armature overcurrent

8.1.11.11 DRIVE TRIP MESSAGE / Supply phase loss (Control supply or EL1/2/3 supply)

8.1.11.12 DRIVE TRIP MESSAGE / Synchronization loss

## 9 SELF TEST MESSAGE

There is a group of self test messages that provide information about problems occurring in the drive itself which are not related to the motion control system. These will appear when the problem occurs and are not saved for later access. They will disappear when the appropriate action is taken to cure the problem

### 9.1.1 SELF TEST MESSAGE / Data corruption

The PL/X has facilities to allow all the parameter settings to be transferred serially from another source using PARAMETER EXCHANGE. This may be from another drive unit or from a computer. The process is called DRIVE RECEIVE. Sending the parameter values to another destination is called a DRIVE TRANSMIT.

This alarm will appear at the end of DRIVE RECEIVE parameter transfer if the drive parameters have been corrupted. The most likely cause for this problem is DRIVE RECEIVE of a corrupted parameter file. The contents of the target recipe page will have been corrupted. However the volatile memory will still hold the values pertaining at the time of the corruption.



If the previously prevailing parameters had been sourced from the now corrupted target recipe page, then it is possible to restore the original recipe. To do this, press the left key and the drive will display the previously prevailing parameters. Then go to the PARAMETER SAVE menu and save these parameters so that the bad data held in the target recipe page is overwritten. Unfortunately the desired new file cannot be used. **If the message occurs at power up then the left key restores factory defaults. IMPORTANT WARNING. Check that the calibration parameters and drive personality arm burden value are correct. These may also need re-entering.**

See 13.13.2 DRIVE PERSONALITY / Recipe page PIN 677

See 13.13.4 DRIVE PERSONALITY / Armature current burden resistance PIN 680

### 9.1.2 SELF TEST MESSAGE / Disable GOTO, GETFROM

The ENABLE GOTO, GETFROM configuration selection has been left in the ENABLE state. This needs to be disabled in order to run the drive.



### 9.1.3 SELF TEST MESSAGE / Self cal tolerance

This alarm will appear at power-up if the self calibration of the analog inputs has exceeded their normal tolerance.

This tolerance can be relaxed by 0.1% with each press of the left key to enable the unit to operate, although possibly at reduced accuracy. It indicates an aged component that has drifted slightly, or a pollution problem.



### 9.1.4 SELF TEST MESSAGE / Proportional armature current cal fail

This alarm will appear at power-up if the self calibration of the proportional armature current amplifier has failed. If turning the control supply off and on does not remove the problem, then a hardware failure is suspected.

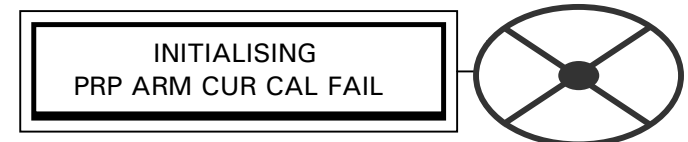

### 9.1.5 SELF TEST MESSAGE / Integral armature current cal fail

This alarm will appear at power-up if the self calibration of the integral armature current amplifier has failed. If turning the control supply off and on does not remove the problem, then a hardware failure is suspected.

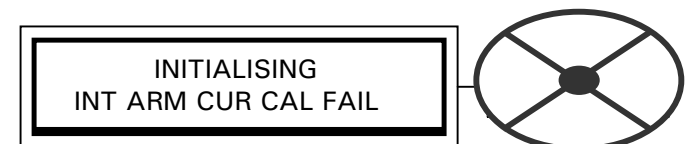

9.1.6 SELF TEST MESSAGE / Stop drive to adjust parameter

This message appears when attempting to alter a parameter which belongs to the class that is inadvisable to adjust while the motor is running.

The message will blink as the up/down keys are pressed. The parameter remains unaltered. The drive must be stopped to adjust the parameter.

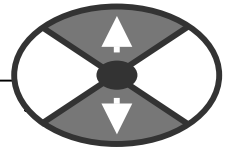

9.1.7 SELF TEST MESSAGE / Enter password

This message appears when attempting to alter a parameter before the correct password has been entered.

The message will blink as the up/down keys are pressed. See 11.2 DISPLAY FUNCTIONS / PASSWORD CONTROL.

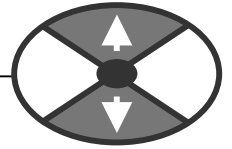
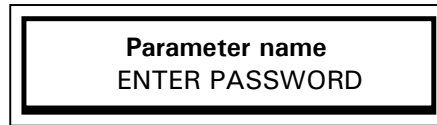

9.1.8 SELF TEST MESSAGE / Enable GOTO, GETFROM

This message appears when attempting to configure connections before the ENABLE GOTO, GETFROM mode has been enabled. The message will blink as the up/down keys are pressed.

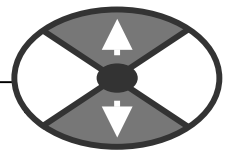
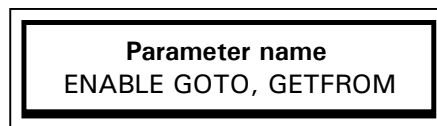

9.1.9 SELF TEST MESSAGE / GOTO CONFLICT

At the end of a configuration session the user must always proceed to the ENABLE GOTO, GETFROM window to set it to DISABLED. This message will then appear if the user has accidentally connected more than one GOTO to any PIN during the session. It will also appear as an alarm message if the drive is asked to run and there is a GOTO CONFLICT. E.g. if a parameter file containing a GOTO CONFLICT has been loaded. See 13.14 CONFLICT HELP MENU.

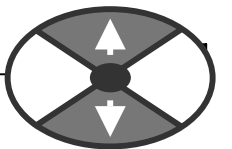

9.1.10 SELF TEST MESSAGE / Internal error code

This message will appear for a variety of reasons. Codes 0001/2/3 indicate a microprocessor system problem. Please consult supplier.

The message SUPPLY PHASE LOSS indicates the control supply has dipped. See 3.6 Supply loss shutdown. Code 0005 appears if a very small motor is run on a large PL/X with a high inductance 3 phase supply. In this case it will be necessary to re-calibrate the model rating to a lower current. See 13.13.4 DRIVE PERSONALITY / Armature current burden resistance PIN 680, and 13.13.4.1 50% / 100% rating select. If this message appears when running then:- 1)The armature current will quench. 2)The main contactor and field will de-energise. 3)The digital outputs will be disabled. 4)The HEALTHY flag (PIN 698) will be set low. Normal operation may be re-instated by pressing the left key or turning the control supply off and on again.

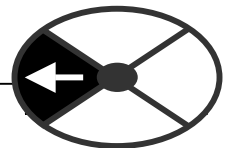
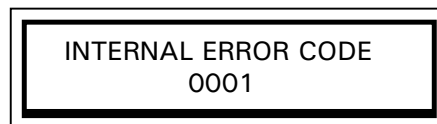

9.1.11 SELF TEST MESSAGE / Authorisation needed

This message will appear if a PARAMETER SAVE on RECIPE PAGE = 3 -KEY RESET , or a DRIVE RECEIVE of a page 3 file, is attempted, AND the page has been locked by the supplier. Page 3 may be locked because it contains a recipe that is required to be protected from being overwritten. Please consult your supplier. It may also appear if certain special parameters are altered, however this is unlikely to happen in normal operation.

WARNING. The lock status is also included in, and travels with a page 3 file. Receiving a page 3 file with locked status will automatically lock any unlocked page 3. See 10.2.1.1 PARAMETER EXCHANGE with a locked recipe page 3.

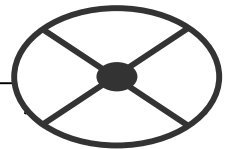

### 9.1.12 SELF TEST MESSAGE / Memory write error

Indicates a save problem.

Usually occurs if the control supply is below 90V AC.



### 9.1.13 SELF TEST MESSAGE / Memory version error

It indicates that a file SAVED using PARAMETER SAVE, with more recent software, has been loaded onto a unit with incompatible older software.

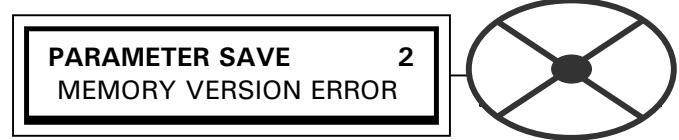

#### Either by host computer using parameter exchange.

To correct the problem, press the left key and the drive will be returned to its factory default values. Unfortunately any desired parameter changes will need to be re-entered and SAVED. Alternatively it may be possible to use PL PILOT to transfer the file. See 9.1.13.1 Transferring files using PL PILOT below.

#### Or by transfer of EEPROM.

In this case the original file in the EEPROM will still be intact and will still work with the original younger version of software. (Transferring IC15 and IC16 as well as the EEPROM may resolve the problem). See 10.2.3.3 PARAMETER EXCHANGE / Eeprom transfer between units.

See 10.2.4 Rules of parameter exchange relating to software version.

#### 9.1.13.1 Transferring files using PL PILOT

**For software versions 4.01 and above** the PL/X can be configured using PL PILOT. This tool works with the parameters in volatile RAM. Recipes stored from any PL/X may be transferred to any other PL/X. Hence a recipe generated on newer software versions may be sent to a PL/X with older software versions. Any parameters that do not exist on the older version will merely produce a comms warning and may be skipped.

See 10.2.5.1 PL PILOT and SCADA (System Control And Data Acquisition) package.

See also 5.3 Archiving PL/X recipes.

Note. PL PILOT is not subject to PASSWORD control.

See 11.2 DISPLAY FUNCTIONS / PASSWORD CONTROL.

## 10 SERIAL LINKS, RS232 and FIELDBUS

<b>10 SERIAL LINKS, RS232 and FIELDBUS .....</b>	<b>151</b>
10.1 SERIAL LINKS / RS232 PORT1 .....	152
10.1.1 RS232 PORT1 / Connection pinouts .....	153
10.1.2 RS232 PORT1 / Port1 Baud rate PIN 187 .....	153
10.1.3 RS232 PORT1 / Port1 function PIN 188 .....	153
10.1.4 How to use USB ports .....	153
10.2 RS232 PORT1 / PARAMETER EXCHANGE .....	154
10.2.1 PARAMETER EXCHANGE / Drive transmit .....	154
10.2.1.1 PARAMETER EXCHANGE with a locked recipe page 3. ....	155
10.2.1.2 Transmitting parameter data file to a PC. Windows 95 upwards.....	155
10.2.2 PARAMETER EXCHANGE / Drive receive .....	156
10.2.2.1 Receiving parameter data file from a PC. Windows 95 upwards.....	156
10.2.3 PARAMETER EXCHANGE / menu list to host .....	157
10.2.3.1 Transmitting a menu list to a PC. Windows 95 upwards.....	157
10.2.3.2 PARAMETER EXCHANGE / Drive to drive.....	158
10.2.3.3 PARAMETER EXCHANGE / Eeprom transfer between units.....	159
10.2.4 Rules of parameter exchange relating to software version.....	159
10.2.5 Parameter exchange using ASCII COMMS .....	160
10.2.5.1 PL PILOT and SCADA (System Control And Data Acquisition) package .....	160
10.3 RS232 PORT1 / PORT1 REF EXCHANGE .....	161
10.3.1 REFERENCE EXCHANGE / Reference exchange slave ratio PIN 189.....	162
10.3.2 REFERENCE EXCHANGE/ Reference exchange slave sign PIN 190 .....	162
10.3.3 REFERENCE EXCHANGE / Reference exchange slave monitor PIN 191 .....	162
10.3.4 REFERENCE EXCHANGE / Reference exchange master monitor PIN 192 .....	162
10.3.5 REFERENCE EXCHANGE / Reference exchange master GET FROM.....	162
<b>11 DISPLAY FUNCTIONS .....</b>	<b>163</b>
11.1 DISPLAY FUNCTIONS / Reduced menu enable.....	163
11.2 DISPLAY FUNCTIONS / PASSWORD CONTROL.....	163
11.2.1 PASSWORD CONTROL / Enter password .....	164
11.2.2 PASSWORD CONTROL / Alter password .....	164
11.3 DISPLAY FUNCTIONS / Language select.....	164
11.4 DISPLAY FUNCTIONS / Software version.....	164
11.5 Remotely mounted display unit.....	164

**WARNING. Comms operation is suspended whilst the unit is in CONFIGURATION mode.**

See 13 CONFIGURATION, and 13.2.7 CONFIGURATION / ENABLE GOTO, GETFROM.

The RS232 PORT1 is a standard product feature providing a daisy chain fast data facility without need for a host (REFERENCE EXCHANGE). Or an ASCII comms proprietary multi-drop link using ANSI-X3.28-2.5-B I protocol. A full description of the ASCII comms facility can be found in the SERIAL COMMS manual.

The RS232 PORT1 is used for configuration with PL PILOT, and archiving recipes via windows hyperterminal.

PL/X units with 5.01 upward software versions can support proprietary fieldbus applications. This requires extra hardware in the shape of :-

- a) Mounting board for FIELDBUS card. (part no. LA102738)
- b) FIELDBUS card. (e.g. Profibus, Devicenet)

The above components are incorporated within the unit and plugged onto the PL/X control card.

There is a sub-menu in the CONFIGURATIONS menu that allows configuration of the parameters to be input and output by the PL/X. See 13.12 CONFIGURATION / FIELDBUS CONFIG.

A full description of the FIELDBUS facility can be found in the SERIAL COMMS manual.

SERIAL LINKS menu

Port1 is a non-isolated RS232 port used for PL/X configuration and serial comms.

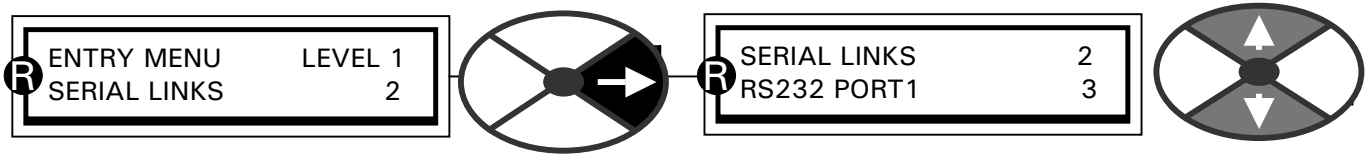

Glossary of terms.

Protocol	The instructions for the order of sending data and handshaking.
Port	The physical connector for the serial link.
RS232, RS422, RS485	Electrical specification standards for serial transmission. (RS – Recommended Standard)
Baud rate	The rate at which the data is sent, which must be matched for all parties.
ASCII	American standard code for information interchange.
ANSI	American national standards institute.

10.1 SERIAL LINKS / RS232 PORT1

PINs used 187 to 192.

The RS232 PORT1 is located just above the middle set of control terminals.

It is a female 4 way FCC-68 type socket.

This port can be used in 2 ways.

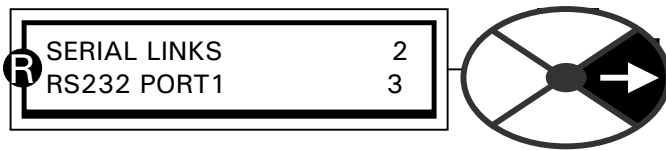

1) For PARAMETER EXCHANGE with other devices.

- a) From another computer or drive in ASCII.
- b) To another computer or drive in ASCII.
- c) To another computer or printer in the form of a text list of display windows and their parameters.

This function may be used to keep records and files of parameter settings, or allow the transfer of parameter settings from an old control board to a new one.

There is also an option to select ASCII COMMS in 188)PORT1 FUNCTION to implement a full duplex ANSI communications protocol for use with a host computer or for interface with a PC based configuration tool. The sub-menu for this function is PORT1 COMMS LINK. Please refer to the SERIAL COMMS MANUAL.

**Note. PORT 1 FUNCTION is not subject to password control for software versions 4.06 and above.**

2) For speed REFERENCE EXCHANGE to or from another unit in digital format during running. This allows low cost digital speed accuracy ratio between drives especially when using encoder feedback. Note. Some computers may not be fitted with an RS232 COM port. Instead they will possess a USB port. In this case it is necessary to fit a USB - RS232 convertor (E.g. Single in line convertor type USB to serial male D9, or multiport type Belkin F5U120uPC). After installation of the convertor drivers, right click on the 'My Computer' icon and select Properties / Device Manager / Ports to find the port allocations. (COM1, COM2, COM3 etc.). Then you must use the nominated USB port allocation within Hyperterminal or PL PILOT. See 10.1.4 How to use USB ports.



10.1.1 RS232 PORT1 / Connection pinouts

The socket is type FCC68 4 way.

pin	function	D pin
W	0V	D5
X	+ 24V	not connected
Y	transmit	D2
Z	receive	D3

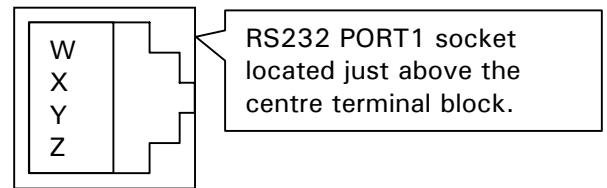

(Unit to host, 9 way female D type part no. LA102595) (Unit to unit 2 metre cable part number LA102596), See 10.2.3.2 PARAMETER EXCHANGE / Drive to drive for connection details)

**Warning the 24V supply on pin 2 may damage your PC or other instrument. If in doubt do not connect it. The PL/X1 transmit must be connected to the PL/X2 receive, and the PL/X1 receive to the PL/X2 transmit.**

10.1.2 RS232 PORT1 / Port1 Baud rate PIN 187

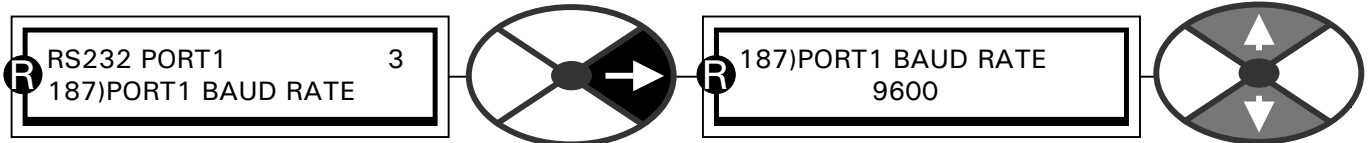

Sets the baud rate of port1 to suit the host.

PARAMETER	RANGE	DEFAULT	PIN
PORT1 BAUD RATE	1 of 9 standard baud rates	9600	187

The standard baud rates available are 300 600 1,200 2,400 4,800 9,600 19,200 34,800 and 57,600. Note. This is not subject to PASSWORD control. See 11.2 DISPLAY FUNCTIONS / PASSWORD CONTROL.

10.1.3 RS232 PORT1 / Port1 function PIN 188

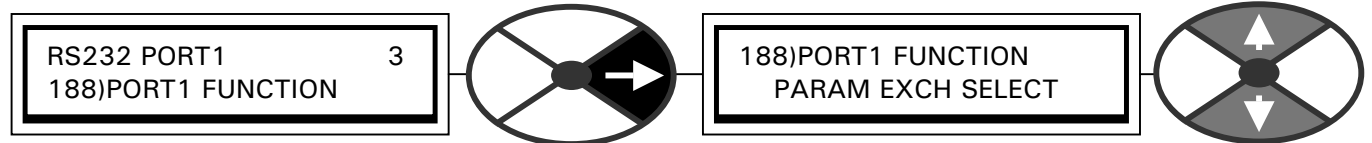

Sets the function of port1.

PARAMETER	RANGE	DEFAULT	PIN
PORT1 FUNCTION	4 modes	PARAMETER EXCH SELECT	188

0) PARAM EXCH SELECT, 1) REF EXCHANGE MASTER, 2) REF EXCHANGE SLAVE, 3) ASCII COMMS

If PARAM EXCH SELECT is selected, proceed to the PARAMETER EXCHANGE sub-menu.  
 If master or slave ref EXCHANGE is selected, proceed to the REFERENCE EXCHANGE sub-menu.  
 ASCII COMMS is selected to implement a full duplex ANSI communications protocol for use with a host computer or the PL PILOT configuration tool. Please refer to SERIAL COMMS MANUAL for specification.

Note. This is not subject to PASSWORD control. See 11.2 DISPLAY FUNCTIONS / PASSWORD CONTROL.

10.1.4 How to use USB ports

Note. Some computers may not be fitted with an RS232 COM port. Instead they will possess a USB port. In this case it is necessary to fit a USB - RS232 convertor (Eg. Single in line convertor type USB to serial male D9, or multiport type Belkin F5U120uPC). These are supplied with the required driver utilities software which needs to be installed on the computer first.

After installation of the driver software, right click on the 'My Computer' icon and select Properties / DeviceManager / Ports to find the port allocated to the convertor. (COM1, COM2, COM3, or COM4.).

Then you must use the nominated USB port allocation when setting up Hyperterminal or PL PILOT.

To select the COM port within PL PILOT go to the 'Options' menu in the top task bar. It will offer COM1, COM2, COM3, or COM4. It may need its baud rate setting to 19,200 in the 'Setup COM Port' option.

**Note. When using USB to RS232 converters always boot up the PC with the converter already plugged into the PC so that it gets properly initialised.**

### 10.2 RS232 PORT1 / PARAMETER EXCHANGE

The RS232 PORT1 can be used to transfer a file of the PL/X settings between the PL/X and a host. The transfer uses an ASCII binary file structure and XON / XOFF protocol. See also 5.3 Archiving PL/X recipes.

The purpose of this facility is to allow the parameter settings to be recorded, or parameter transfer from an old to new control board.

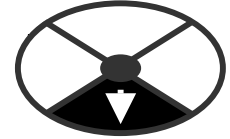
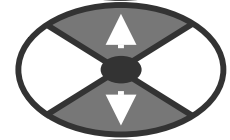
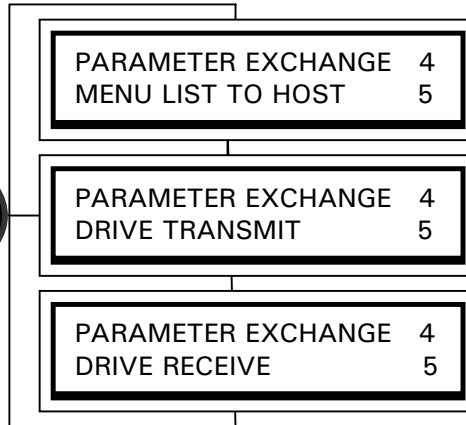
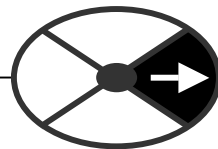

- a) From another computer or drive in ASCII.
- b) To another computer or drive in ASCII
- c) To another computer in the form of text list of display windows and their parameters.

Transmitting parameters from the PL/X to a host is defined as DRIVE TRANSMIT whereas receiving data by the PL/X from a host is defined as DRIVE RECEIVE.

RS232 PORT1 Setup. Set the PL/X RS232 PORT1 baud rate to match the host port baud rate

When using a computer or printer, set its serial port to work with the following fixed protocols.

1 Stop bit NO Parity 8 bits XON/XOFF Handshaking

To use the PARAMETER EXCHANGE sub-menu, first choose PARAM EXCH SELECT in the previous menu window called RS232 PORT1 / 188)PORT1 FUNCTION.

#### 10.2.1 PARAMETER EXCHANGE / Drive transmit

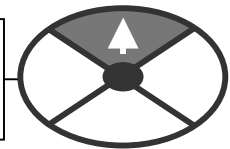
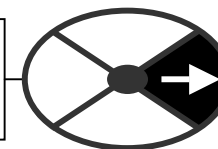

Starts transmission of the parameter file in 677)RECIPE PAGE, to the host.

PARAMETER	RANGE
DRIVE TRANSMIT	TRANSMITTING then FINISHED

See 10.2.4 Rules of parameter exchange relating to software version.

This is the transfer of the Parameter file from the page selected in 677)RECIPE PAGE from the PL/X to a host computer. This file information fully describes the PL/X 's settings for the chosen page, in a binary format.

**The file is of the drive's saved settings for the chosen page**, which will not be the present settings if changes have been made without performing a PARAMETER SAVE. Read only values will be at the level pertaining at the time of transmission. **The files for each RECIPE PAGE may be transmitted irrespective of the displayed set.** Note. The source page is included in the file, this ensures that the file will return to the same page if it is received by any unit. See also 5.3 Archiving PL/X recipes.

- 1) Connect the PL/X to the host using the appropriate lead. See 10.1.1 RS232 PORT1 / Connection pinouts.
- 2) Using a standard communications package prepare the host to receive an ASCII file. Remember to set up the host's serial port first. See 10.2.1.2 Transmitting parameter data file to a PC. Windows 95 upwards.
- 3) Make sure that the PORT1 FUNCTION has been set to PARAM EXCH SELECT.
- 4) Get the host ready to receive a file, use the file extension .TXT  
(Suggest using .TX2 page 2, .TX3 for page 3, .TXL for Locked page 3).
- 5) Start transmitting on the PL/X by selecting DRIVE TRANSMIT followed by the up key.
- 6) The file ends in a CTRL-Z. With some packages this automatically closes the file. If this is not the case, when the PL/X says it has FINISHED and the host has stopped scrolling text or printing, close the file manually. The last line should read : 0 0 0 0 0 0 1 F F.
- 7) The file can now be saved for back up.

### 10.2.1.1 PARAMETER EXCHANGE with a locked recipe page 3.

Page 3 may be locked by the factory to prevent overwriting. To find out if page 3 is locked first do a 3-KEY RESET and then perform a PARAMETER SAVE. If the message AUTHORISATION NEEDED appears then page 3 is locked. The lock status is included in, and travels with a page 3 file to a host computer. Receiving a page 3 file with locked status, from a computer, will automatically lock any unlocked page 3. If page 3 is already locked it will not receive any file, either locked or unlocked. To remove the lock from a page 3 recipe on the PL/X, first SAVE it on a free page (eg page 2) of the PL/X. This copies the page 3 contents on to page 2, which discards the lock. Then transmit this **page 2 file** to the computer for use with other PL/Xs. See 13.13.2 DRIVE PERSONALITY / Recipe page PIN 677.

### 10.2.1.2 Transmitting parameter data file to a PC. Windows 95 upwards.

(Microsoft HyperTerminal, part of Accessories in Windows '95).

The first part of this section describes how to create a personalised Hyperterminal which once created, may be used for all PARAMETER EXCHANGE functions between host computers and the PL/X.

On computers supplied with Windows '95 upwards, this program is to be found as standard in the folder "Accessories". To use it click on **Start** then travel through **Programs**, **Accessories** and click on **Hyper Terminal**. Double click on the Hypertrm.exe icon or highlight it and click on **File** then **Open**.

It is now necessary for you to create a personalised Hyperterminal that can be used to receive or send parameter files to the PL/X. (Note this tool does not hold any parameter files, it only handles the files).

You will be asked for a **Name** for the connection and an **Icon** – use your name, or your company name for example. Then choose one of the icons offered. Once you have finished click on **OK**.

Having done this you will be asked for a telephone number to dial – this can be ignored as you are connecting a drive to the host computer, but you need to select whichever port you are using for the connection to the drive – Com 1 for example. Select from the **Connect using** menu by clicking on the down arrow and highlighting the appropriate selection.

Click on **OK** and select the port settings. The settings should be set to:

(Baud rate) match PL/X baud rate, 8 **Data bits**, **Parity** none, 1 **Stop bit** and Xon/Xoff **Flow control**.

Select each of these from the menu choices available as above. Note that **Advanced** port settings can be left as defaults unless you have problems with data corruption during transmission or reception. Click on **OK** when you have finished selecting the port settings.

Now click on **File**, **Properties**, **Settings** and check that **Emulation** is set to Auto detect. The setting of **Backscroll buffer lines** should be zero.

In addition, click on ASCII Setup and confirm that **Append line feeds to incoming line ends** and **Force incoming data to 7 bit ASCII** are unchecked and that **Wrap lines that exceed terminal width** is checked. Click on **OK** then **OK** again in the previous menu to finish. It is recommended that the above settings are saved.

**When you have completed and saved the above you will have a personalised Hyperterminal that may be used at any time to send or receive PL/X parameter files, and there will be no need to repeat the above.**

It is now necessary to save the captured PL/X data in a format that can be transmitted to this or another drive at a later date. Click on **Transfer** then **Capture text** and you will be asked for a folder and file for the captured data to be stored in. Choose an appropriate destination and name using the default file extension TXT. (Suggest using TX2 page 2, TX3 for page 3, TXL for Locked page 3). When you are finished click on **Start**.

HyperTerminal now returns to the main screen and is ready for reception. You will notice that the bottom menu bar now highlights "Capture".

Proceed to transmit drive data as outlined in PARAMETER EXCHANGE. Once transmission is complete and the drive reports "FINISHED" click on the disconnect icon or click on **Call** then **Disconnect** to finish.

You may now exit from HyperTerminal by clicking on **File** then **Exit** or by pressing Alt and F4 or by closing the window. It is not necessary to save the session if your personalised Hyperterminal has been saved as described above. The file of received data has now been saved ready for transmission to another or the same drive. See also 5.3 Archiving PL/X recipes.

## 10.2.2 PARAMETER EXCHANGE / Drive receive

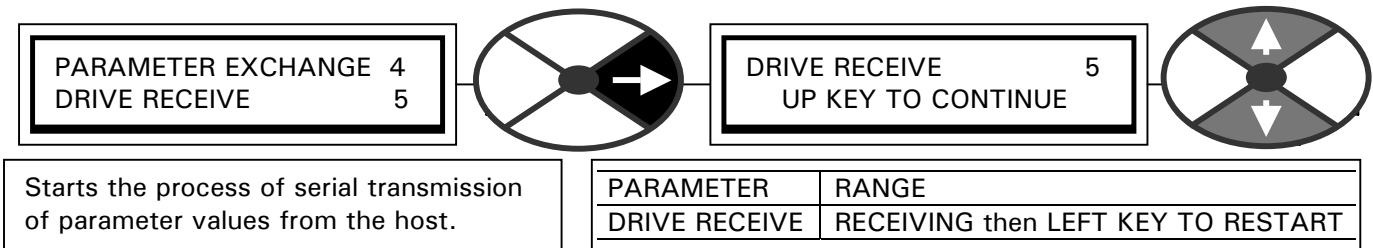

See 10.2.4 Rules of parameter exchange relating to software version. See also 5.3 Archiving PL/X recipes. This is the transfer of the Parameters from the host to the PL/X. This information is written directly to the drive's permanent memory, so **the drive's present settings for the TARGET RECIPE PAGE will be overwritten**. The file will contain its recipe page source (Normal, 2, 3) and will automatically save on that recipe page. See also. 10.2.1.1 PARAMETER EXCHANGE with a locked recipe page 3

- 1) Connect the PL/X to the host using the appropriate lead. See 10.1.1 RS232 PORT1 / Connection pinouts.
- 2) Using a standard communications package, prepare the host to send an ASCII file. Remember to set up the host's serial port first. See 10.2.2.1 Receiving parameter data file from a PC. Windows 95 upwards.
- 3) Make sure that the PORT1 FUNCTION has been set to PARAM EXCH SELECT.
- 4) Enter this menu, when the PL/X says RECEIVING; begin the file transmission by the host computer.  
Note. If the message AUTHORISATION NEEDED appears on the PL/X display it means recipe page 3 has been locked and cannot be overwritten. Please refer to supplier. See also. 10.2.1.1 PARAMETER EXCHANGE with a locked recipe page 3
- 5) The file ends in a 0 0 0 0 0 0 1 F F which the PL/X uses to automatically SAVE the file.
- 6) The PL/X must now be reset by pressing the LEFT key. (This resets to recipe page NORMAL RESET. To see other pages the appropriate power up reset must then be actioned).
- 7) If there has been a problem there may be a message. See 9.1.1 SELF TEST MESSAGE / Data corruption.
- 8) **WARNING. Check the CALIBRATION parameters are correct after this process.**  
Note. There is a hidden pin 708)REMOTE PARAM RCV which is a logic input that can initiate a drive receive.

## 10.2.2.1 Receiving parameter data file from a PC. Windows 95 upwards.

See 10.2.4 Rules of parameter exchange relating to software version. See also 5.3 Archiving PL/X recipes. (Microsoft HyperTerminal, part of Accessories in Windows '95 upwards).

If you have not already created a personalised Hyperterminal please see 10.2.1.2. Transmitting parameter data file to a PC. Windows 95 upwards.

This description assumes you have already stored a parameter file from a PL/X. See 10.2.1.2

Open your personalised Hyperterminal and click on **T**ransfer then **S**end **T**ext **F**ile and you will be asked for a folder and file that was used for the previously captured data you wish to send to the PL/X. Highlight the file from the list provided and it will be selected ready for sending. **Do not click on Open yet.**

Prepare the drive to receive data as outlined in PARAMETER EXCHANGE. This information is written directly to the drive's permanent memory, so **the drive's present settings for the target recipe page will be overwritten**. The file will contain its original recipe page source (Normal, 2, 3) and will automatically save on that recipe page. Once the drive reports "RECEIVING" click on **Open**. The drive will receive the data and report "LEFT KEY TO RESTART" when complete. (This resets to recipe page NORMAL RESET. To see other pages the appropriate power up reset must be actioned). The new parameter data file, including calibration values, has been automatically saved in the PL/X.

Click on the disconnect icon or click on **Call** then **Disconnect** to finish.

You may now exit from HyperTerminal by clicking on **File** then **Exit** or by pressing Alt and F4 or by closing the window. You will be asked if you wish to save the session, this is not necessary so choose **No**.

**WARNING. Check the CALIBRATION parameters are correct after this process.**

10.2.3 PARAMETER EXCHANGE / menu list to host

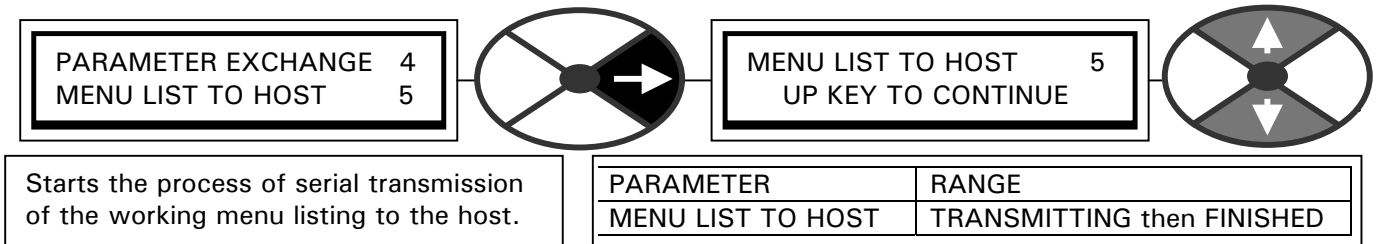

Starts the process of serial transmission of the working menu listing to the host.

This is the transfer of the menu list description including all values from the PL/X to a host computer or printer. This information fully documents the PL/X 's working settings in a clear textual format.

Note. Any parameter that has been changed from the factory default will have a space followed by a character at the end of the line. The character may be a £ or # or other, depending on the host. **The listing is of the drive's present working settings**, which may or may not have been saved permanently using PARAMETER SAVE. **The source of the settings depends on the power up reset type that occurred on the last application of the control supply**, and any changes that have been made prior to transmission. See 13.13.2 DRIVE PERSONALITY / Recipe page PIN 677. Read only values show the level pertaining at the time.

- 1) Connect the PL/X to the host using the appropriate lead. See 10.1.1 RS232 PORT1 / Connection pinouts.
- 2) Using a standard communications package prepare the host to receive an ASCII file. Remember to set up the host's serial port first. See 10.2.1.2. Transmitting parameter data file to a PC. Windows 95 upwards.
- 3) Make sure that the PORT1 FUNCTION has been set to PARAM EXCH SELECT.
- 4) Get the host ready to receive a file, use the file extension PRN. (Suggest using PR2, PR3 for pages 2, 3).
- 5) Start transmitting on the PL/X by selecting MENU LIST TO HOST followed by the up key.
- 6) The file ends in a CTRL-Z. With some packages this automatically closes the file. If not, when the PL/X says it has FINISHED and the host has stopped scrolling text or printing, close the file manually.
- 7) The file can now be treated like any normal text file.

**Note. It is also possible to print a menu list from the total instrument drop down list within PL PILOT.**

10.2.3.1 Transmitting a menu list to a PC. Windows 95 upwards.

On computers supplied with Windows '95 upwards, this program is found in the folder "Accessories". See also 5.3 Archiving PL/X recipes. This description assumes you have created and are using a personalised Hyperterminal.

If you have not already created a personalised Hyperterminal please see 10.2.1.2. Transmitting parameter data file to a PC. Windows 95 upwards.

You now have a choice regarding what will happen once your personalised HyperTerminal receives data. Click on Transfer then **C**apture to Printer if you want the file sent automatically to your default printer.

Note. The listing sent by the drive cannot be looked at whilst you are running HyperTerminal. The personalised Hyperterminal is only used to handle the list, not to store it.

Click on Transfer then **C**apture text and you will be asked for a folder and file for the data to be captured. Chose an appropriate destination and name, and use a file extension appropriate to the word processor you intend using. The defaults .PRN or .PR2 or .PR3 can be used by most, another example is .DOC for Microsoft Word etc. When you are finished click on **S**tart.

HyperTerminal now returns to the main screen and is ready for reception. You will notice that the bottom menu bar now highlights "Capture" and/or "Print echo" depending on which of the above you have selected. Proceed to transmit data as outlined in PARAMETER EXCHANGE. **The source of the settings depends on the power up reset type that occurred on the last application of the control supply**, and any changes that have been made prior to transmission. See 13.13.2 DRIVE PERSONALITY / Recipe page PIN 677.

Read only values will show the level pertaining at the time. Once data is received and the drive reports "Finished", click on the disconnect icon or click on **Call** then **Disconnect** to finish.

You may now exit from HyperTerminal by clicking on **File** then **Exit** or by pressing Alt and F4 or by closing the window. You will be asked if you wish to save the session, this is not necessary as your personalised Hyperterminal already exists.

If you previously selected **Capture text**, the file of received menu listing can now be loaded into whichever word processor you are using to be viewed or printed etc.

### 10.2.3.2 PARAMETER EXCHANGE / Drive to drive

See 10.2.4 Rules of parameter exchange relating to software version.

During maintenance it is sometimes not possible to transfer parameter settings using computers, but may be necessary to transfer settings from one unit to another.

To overcome this problem the PL/X has a built in ability to exchange parameters between two functioning control cards. This method may be used if there is a problem with the power chassis but the unit still responds to the application of the control supply as normal. For faulty units see 10.2.3.3 PARAMETER EXCHANGE / Eeprom transfer between units.

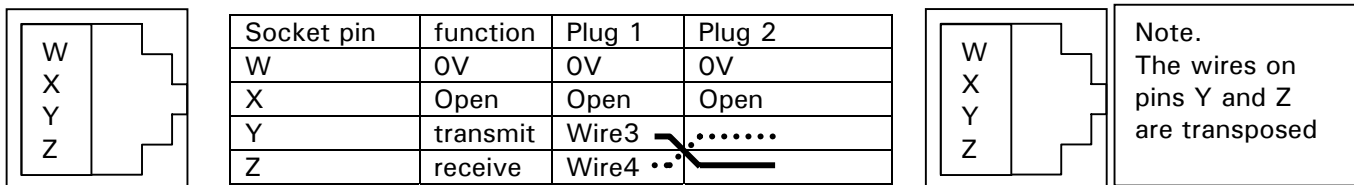

(Unit to unit 2 metre cable part number LA102596. Unit to host, 9 way female Dtype part no. LA102595). Turn on the control supply to the source and target PL/Xs. The display and keys on both units should be working in order to proceed with this transfer technique. Connect the RS232 PORT1 of the source PL/X to the RS232 PORT1 of the target PL/X using an appropriate lead wired between plug 1 and plug 2 as above, with pins Y and Z transposed, and pin X disconnected. **The socket is type FCC68 4 way**

The recipe page of the transmitted file depends on the recipe page selection in the source PL/X. See 13.13.2 DRIVE PERSONALITY / Recipe page PIN 677. Only one page is sent each time. To send all three pages requires three separate transmission sequences. The recipe page selected on the source PL/X also determines its page destination on the target PL/X.

Provided the displays and keys are operating on both units you may proceed to 10.1.2 RS232 PORT1 / Port1 Baud rate PIN 187 and set the baud rates for each unit to be 9600.

Then proceed to 10.2.1 PARAMETER EXCHANGE / Drive transmit on the source PL/X, followed by 10.2.2 PARAMETER EXCHANGE / Drive receive on the target PL/X.

With the target PL/X in the DRIVE RECEIVE window, press the up key to place it in a RECEIVING mode. Return to the source PL/X and in the DRIVE TRANSMIT window press the up key to commence / TRANSMITTING.

Note. If the message AUTHORISATION NEEDED appears it means recipe page 3 has been locked ON THE RECEIVING unit and cannot be overwritten. See 13.13.2.1 Recipe page block diagram or refer to supplier.

When the messages change to FINISHED, press the left key on the target PL/X. Look at the calibration parameters and other unique parameters to ascertain with confidence that the configuration has been transferred, then turn off both the control supplies. Remove the interconnecting lead. The target PL/X is now loaded with the parameter file from the source PL/X.

### 10.2.3.3 PARAMETER EXCHANGE / Eeprom transfer between units

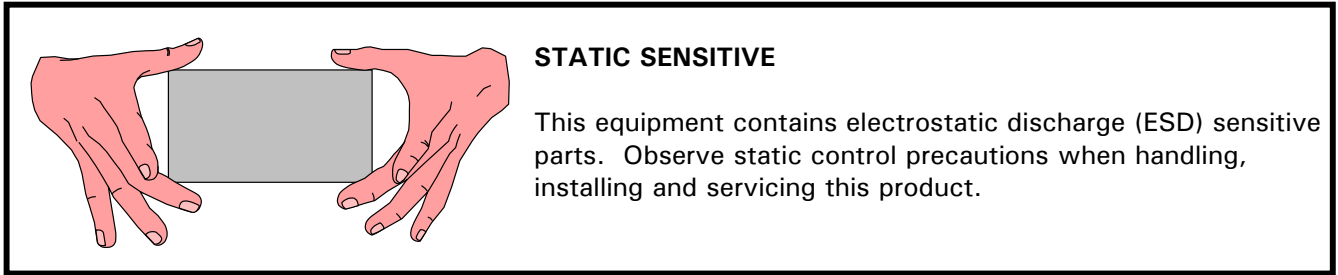

In an emergency break down situation it is possible to transfer the Eeprom IC. This IC contains all 3 recipe page parameters and connection details. See 13.13.2 DRIVE PERSONALITY / Recipe page PIN 677.  
 See 9.1.13 SELF TEST MESSAGE / Memory version error.  
 See 10.2.4 Rules of parameter exchange relating to software version before proceeding.

To gain access to the Eeprom IC it is necessary to remove the plastic cover from the unit. To do this first remove the end caps, then remove the 4 corner fixing screws that retain the cover. When removing the cover please take care not to stress the display and key connection ribbons. Unplug the ribbons from the control card to completely remove the top cover. The plugs are keyed to ensure correct reconnection.

**WARNING. During IC insertion avoid bending the control card and causing damage. This is best achieved by removing the control card and supporting it on a suitable surface. Special attention must be paid to providing support to the card in the area of the IC being inserted, to avoid stressing the surrounding components.**  
 See 13.13.4.3 Changing control or power cards.

The IC is a 28 pin dual in line type. Component legend IC17. It is located on the right hand side of the control board. Remove the one from the new unit first. Then remove the one from the old unit and insert it in the new unit without letting the pins fold under or mislocate in the socket. It is advisable to label the ICs prior to removal. Make sure that the IC is inserted without rotation, with PIN 1 at the lower right hand corner.

Summary. Take out IC17 of the new PL/X and replace with IC17 from the old PL/X.  
 Maintain correct orientation, do not allow pins to fold under or mislocate.  
 Do not bend the control card during this process.

This process must be documented to retain correct version control for future maintenance procedures.  
**WARNING. Check the CALIBRATION parameters are correct after this process.**

### 10.2.4 Rules of parameter exchange relating to software version

The rules governing the ability of a parameter file to be transferred to a PL/X are very simple.

1) A parameter set generated on older software versions is allowed to be transferred to newer versions, but not from newer to older. (However see 9.1.13.1 Transferring files using PL PILOT).

E.g. A file generated using version 2.12 software may be used on units employing version 2.12, 2.13 ---- 3.01 software etc. but not on units employing 2.11, 2.10 ---- 2.01 etc.

The system is designed in this way because a replacement unit is more likely to have newer software.

A newer version of software may possess parameters that did not exist on earlier versions. When an earlier version file is transmitted to the newer version, it automatically uses the default values for any parameters it cannot find in the older version file. Once the new parameters have been adjusted and a PARAMETER SAVE performed then they will become permanently memorised. These rules apply for all modes of file transfer.

See 11.5 Remotely mounted display unit.

If the message MEMORY VERSION ERROR appears it indicates that an incompatible newer software file has been loaded onto a unit with older software. See 9.1.13 SELF TEST MESSAGE / Memory version error.  
 See 9.1.13.1 Transferring files using PL PILOT.

### 10.2.5 Parameter exchange using ASCII COMMS

ASCII COMMS is an ANSI multi-drop protocol for use with a host. (refer to SERIAL COMMS manual) or for interface with a PC based configuration tool. (PL PILOT). See below and 13.1.1 PL PILOT configuration tool. See also 5.3 Archiving PL/X recipes. See also 11.5 Remotely mounted display unit.

Note. The PL/X uses an RS232 port to transmit serial data. Some computers may not be fitted with an RS232 COM port. Instead they will probably possess a USB port. In this case it is necessary to fit a USB - RS232 convertor to the computer (Eg. Single in line convertor type USB to serial male D9, or multiport type Belkin F5U120uPC). These are supplied with the required driver utilities. After installation of the convertor, right click on the 'My Computer' icon and select Properties / Device Manager / Ports to find the port allocations. (COM1, COM2, COM3 etc.). Then you must use the nominated USB port allocation when setting up comms utilities. Eg. Hyperterminal or PL PILOT.

#### 10.2.5.1 PL PILOT and SCADA (System Control And Data Acquisition) package

There is a proprietary PC based SCADA (System Control And Data Acquisition) package available which is fully configured to communicate with the PL/X range. This package provides many features, including.

PL/X Configuration	Data logging	Alarm logging	Recipe management
Multi-drop capability	Bar charts	Drawing package	Full parameter monitoring
Chart recording	Multi-instrument views	Multiple comm ports	Bit map graphics import

The SCADA package is designed by SPECVIEW, and forms the platform for the PL PILOT config tool. Further details about this package are accessible from the entry page of the PL PILOT configuration tool.

PL PILOT runs on a standard PC (Windows 95 upwards). It can set any parameter value, make any legal internal connection, and monitor all the available parameters. It provides the user with block diagrams where each parameter may be quickly accessed and altered. The system allows recipes of drive configurations to be stored and/or down loaded as desired. It may also be operated off-line to develop and save recipes.

PL PILOT is also able to support up to 10 drives on one link. It can access all parameters, connections and diagnostics for each drive. It is able to display these from any drive or combinations of drives and send recipes to any drive on the link.

This powerful tool is available free of charge and is supplied on a CD with the PL/X. The operating instructions for PL PILOT are accessed within the tool itself by using the HELP BUTTON.

**Click on the Help BUTTON in the top right hand corner of the PL PILOT entry menu for further information.** To install from the CD, follow the self launching instructions when the CD is inserted into the PC.

For users that are installing for the first time select. 'Typical' in the 'Setup type' dialog box. For users that are installing the latest version on systems with an existing version select 'Repair'. If you have existing recipes in the previous version these will automatically be retained in the latest version.

**If you have to change any com port settings on the computer, or save changed serial link parameters on the PL/X, then you may need to turn the PL/X off and on again to clear the comms buffers of false data before the system will start communicating.** See also 10.1.4 How to use USB ports.

There is a suitable cable supplied to connect the PC COM 1 serial port to PL/X RS232 PORT1. 187)PORT1 BAUD RATE. Set to 19200 on the target PL/X, and in 'Options' / 'Setup COM Port' in PL PILOT. 188)PORT1 FUNCTION. Set to ASCII COMMS on the target PL/X.

Warning. PL PILOT may add up to 10mS to PL/X cycle times, which may affect the response of applications that require fast sampling. Eg. SPINDLE ORIENTATE. To overcome this effect, reduce the baud rate.

Note. PL PILOT is not subject to the PASSWORD. See 11.2 DISPLAY FUNCTIONS / PASSWORD CONTROL. See also 5.3 Archiving PL/X recipes.



### 10.3 RS232 PORT1 / PORT1 REF EXCHANGE

Allows the accurate transmission of parameters (typically a reference) between units with the same OV. (The slave/master mode is set by PORT1 FUNCTION).



In MASTER mode the unit **initiates** high bandwidth transmission of data, and can also receive data.

In SLAVE mode the unit **waits** to receive data and then immediately transmits its own data.

Using a GETFROM to source the transmit data, and and a GOTO to target the received data, within each PL/X in the chain, gives ultimate flexibility to the user. See 13.2 Configurable connections.

This function could of course be implemented by using an analogue signal connection between the drives. However if the system requires greater speed and accuracy, then this method may be employed.

See 10.1.1 RS232 PORT1 / Connection pinouts for details of the transmit / receive connections.

Daisy chain. When using more than 2 units, connect RS232 PORT 1 to an external terminal block to separate the transmit and receive connections. E.g. from MASTER transmit to SLAVE1 receive, and from SLAVE1 transmit to SLAVE 2 receive etc. The last SLAVE transmit can connect to the MASTER receive if desired.

With 2 units, the MASTER may use spare SLAVE blocks. (Send an input, and receive the output).

For information about transmission errors see 8.1.11.15 DRIVE TRIP MESSAGE / Bad reference exchange.

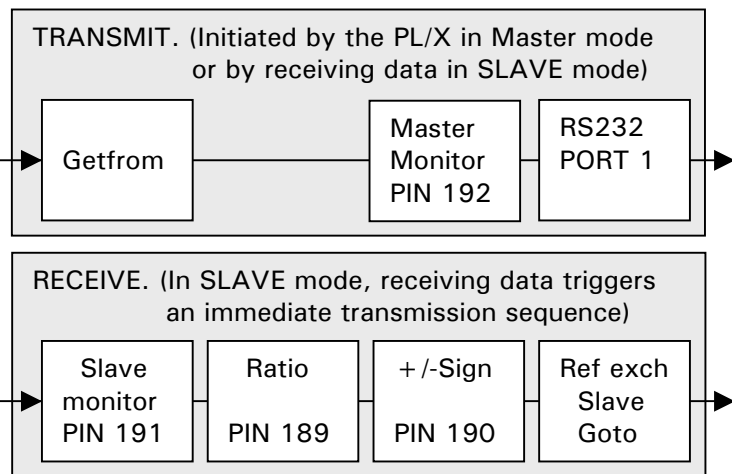
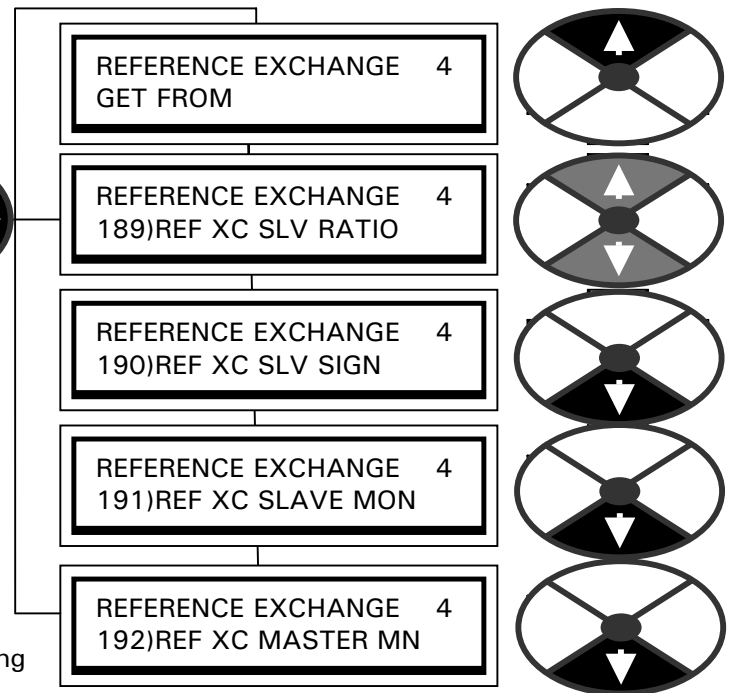

**Multi Drive Digital speed locking.** Daisy chain using reference exchange and encoder feedback for each drive. When using this for digital speed accuracy, it is important that the remaining analogue inputs do not inject small errors into the loop when they are dormant. See 6.7 CHANGE PARAMETERS / SPEED CONTROL. Useful tips for eliminating unwanted analogue references.

1) The RUN MODE RAMP output will remain at precisely zero providing the Ramp Hold (T16) input is permanently high and the ramp is not permanently preset to a non-zero value. The ramp input may often be used by line master drives, but in the slave drive the ramp should be disabled using T16. Note that the incoming digital reference may be passed through the ramp function by re-configuring the appropriate internal PL/X connections. In this case, the analogue input to the ramp (terminal T4) is disconnected.

2) Analogue input 2 (T2) may be used for inching references. In which case it should be re-connected via input 1 of the SUMMER 1 apps block, which possesses a deadband function. During normal running, the terminal is shorted to OV or left open circuit. This ensures no signal passes if the input remains within the deadband. The analogue inch reference is set above the deadband so as to give the required inching speeds, forward or backward. Selection between analogue inching and absolutely zero is thus automatic. If T2 is not being used it may be dis-connected, or the UIP2 scaler on PIN 322 should be set to 0.0000.

3) Zero input 3 (T3) using 6.6.7 SPEED REF SUMMER / Speed/Current Reference 3 ratio PIN 67.

10.3.1 REFERENCE EXCHANGE / Reference exchange slave ratio PIN 189

REFERENCE EXCHANGE 4  
189)REF XC SLV RATIO

189)REF XC SLV RATIO  
1.0000

Scales the incoming parameter for use within the unit.

PARAMETER	RANGE	DEFAULT	PIN
REF XC SLV RATIO	+/-3.0000	1.0000	189

Note. In SLAVE mode, when data is received, it initiates an immediate transmit of its **own** GETFROM data.

10.3.2 REFERENCE EXCHANGE/ Reference exchange slave sign PIN 190

REFERENCE EXCHANGE 4  
190)REF XC SLV SIGN

190)REF XC SLV SIGN  
NON-INVERT

Used to invert the incoming parameter.

PARAMETER	RANGE	DEFAULT	PIN
REF XC SLV SIGN	NON-INVERT or INVERT	NON-INVERT	190

Note. In SLAVE mode, when data is received, it initiates an immediate transmit of its **own** GETFROM data.

10.3.3 REFERENCE EXCHANGE / Reference exchange slave monitor PIN 191

REFERENCE EXCHANGE 4  
191)REF XC SLAVE MON

191)REF XC SLAVE MON  
0.00%

Monitors the RS232 port 1 incoming data in both modes.

PARAMETER	RANGE	PIN
REF XC SLAVE MON	+/- 300.00%	191

In MASTER mode the receive channel still accepts data. E.g. A MASTER unit can borrow a SLAVE unit block.

10.3.4 REFERENCE EXCHANGE / Reference exchange master monitor PIN 192

REFERENCE EXCHANGE 4  
192)REF XC MASTER MN

192)REF XC MASTER MN  
0.00%

Monitors the outgoing data prior to RS232 port 1 transmit.

PARAMETER	RANGE	PIN
REF XC MASTER MN	+/- 300.00%	192

Note. In MASTER mode the unit **initiates** transmission. In SLAVE mode transmission is **initiated by reception**.

10.3.5 REFERENCE EXCHANGE / Reference exchange master GET FROM

REFERENCE EXCHANGE 4  
GET FROM

GET FROM  
XXX)Description of function

Defines the source PIN for data to output via the TRANSMIT channel

PARAMETER	RANGE	DEFAULT
GET FROM	PIN 000 to 720	400

This is the data that will be transmitted by a master, **and by a slave in response to receiving data**. Hence to cascade units there is one MASTER feeding the first SLAVE, then the first SLAVE feeds the second SLAVE etc. The data being received in each unit is connected internally by the REF EXCH SLAVE GOTO in the BLOCK OP CONFIG menu. The data being sent to the next unit is determined by this GETFROM.

### 11 DISPLAY FUNCTIONS

This menu is used to alter the display presentation.

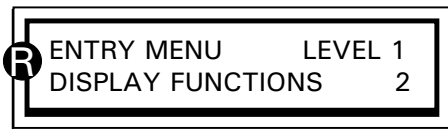

The REDUCED MENU shows only the commonly used selections and enables more rapid travel around the tree structure. There are 2 sets of reduced menu parameter values that can be selected. See 6.1.17 CALIBRATION / Motor 1 or 2 select PIN 20 .

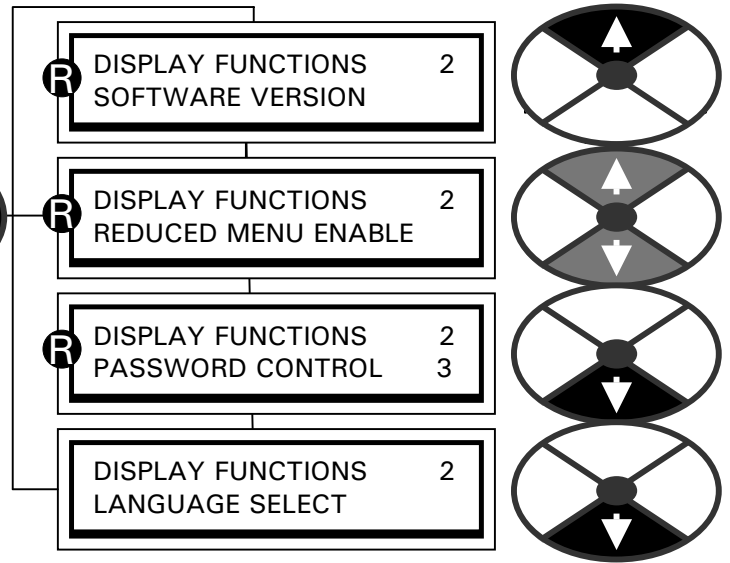

**R** If you see this symbol in the manual, this indicates that the window is in the reduced and full menu.

#### 11.1 DISPLAY FUNCTIONS / Reduced menu enable

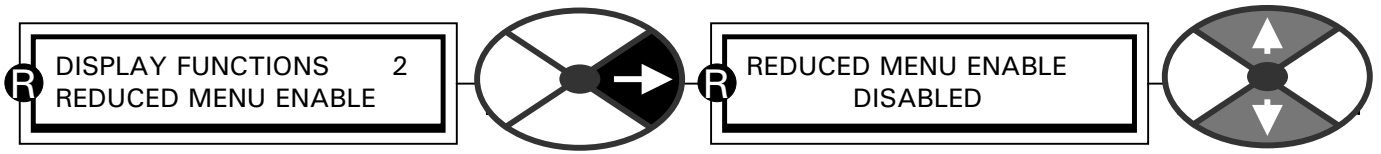

Enables the reduced menu display format.	PARAMETER	RANGE	DEFAULT
	REDUCED MENU	ENABLED or DISABLED	DISABLED

See 6.1.17 CALIBRATION / Motor 1 or 2 select PIN 20

#### 11.2 DISPLAY FUNCTIONS / PASSWORD CONTROL

The password will prevent accidental alteration by unauthorised users. It does not protect against sabotage. It allows a password to be required prior to parameter changes. The default password and power up entry are both 0000. So a PL/X that has not had a password alteration is always unlocked.

An altered password is not retained after removal of the control supply unless a PARAMETER SAVE has been actioned. If a parameter change is tried without a valid password entry then the message ENTER PASSWORD

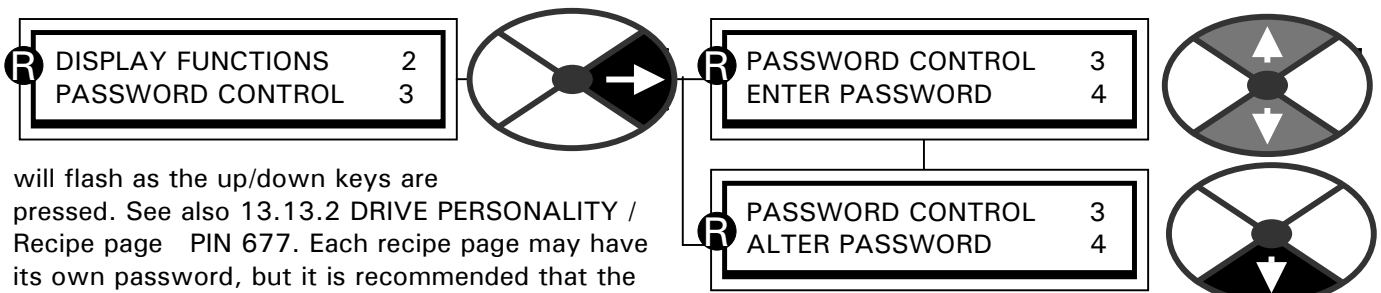

will flash as the up/down keys are pressed. See also 13.13.2 DRIVE PERSONALITY / Recipe page PIN 677. Each recipe page may have its own password, but it is recommended that the same password is used for every page to avoid confusion. A file copied using parameter exchange will carry the password from the source page. If that file is transmitted to another drive unit, the password will be carried with it. This requires careful housekeeping.

Note. PL PILOT, PORT 1 FUNCTION and 187)PORT1 BAUD RATE are not subject to password control. Hence it is possible to overcome the problem of forgetting passwords by using the PL PILOT config tool to save the recipe. It may then be re-loaded after the password has been restored to 0000 on recipe page NORMAL RESET using a 4-KEY RESET. See 5.1.3 Restoring the drive parameters to the default condition.

11.2.1 PASSWORD CONTROL / Enter password

Enter the correct password here to alter parameters.

PARAMETER	RANGE	DEFAULT
ENTER PASSWORD	0000 to FFFF	0000

If the entered password is correct, then the ALTER PASSWORD window will show the password. If it is incorrect then the ALTER PASSWORD window will show \*\*\*\*. Each recipe page may have its own password. See 13.13.2 DRIVE PERSONALITY / Recipe page PIN 677.

11.2.2 PASSWORD CONTROL / Alter password

To alter the password, scroll the new password here.

PARAMETER	RANGE	DEFAULT
ALTER PASSWORD	0000 to FFFF	0000

To alter the password, enter the existing password in the ENTER PASSWORD window first. Then using this window, change to the new desired password. The altered password is immediately effective and copied to the ENTER PASSWORD window, but only retained for the next power up if a PARAMETER SAVE is performed, otherwise the previous password will be required again.

11.3 DISPLAY FUNCTIONS / Language select

Use this window to alter the display language.

PARAMETER	RANGE	DEFAULT
LANGUAGE SELECT	0 to 3	0

Note. English or French is available for version 5.14 software.

11.4 DISPLAY FUNCTIONS / Software version

This window shows the version number of the installed code.

PARAMETER	RANGE
SOFTWARE VERSION	Version number

See 10.2.4 Rules of parameter exchange relating to software version.

11.5 Remotely mounted display unit

There is a family of proprietary Terminal Interface Units (TIU) available that are compatible with the PL/X. The font contains a bright and clear display with an adjustable backlight. All the PL/X parameters are accessible by the TIU which can support up to 300 menu and sub-menu pages. Each page can display up to 8 parameters including numeric, alphanumeric and bit status. Parameters can be displayed and/or altered, and users can attach their own display messages to status bits. The TIU is configured with a windows-based software. The supply and comms connection to the TIU is from the PL/X RS232 PORT1. Please refer to your supplier for further information.

## 12 APPLICATION BLOCKS

The PL/X contains a comprehensive range of extra system application blocks. These are described in a separate accompanying manual. At the time of publication, the list of blocks is as follows

APPLICATION BLOCKS / SUMMER 1, 2  
 APPLICATION BLOCKS / PID 1, 2.  
 APPLICATION BLOCKS / PARAMETER PROFILER  
 APPLICATION BLOCKS / REEL DIAMETER CALC  
 APPLICATION BLOCKS / TAPER TENSION CALC  
 APPLICATION BLOCKS / TORQUE COMPENSATOR  
 APPLICATION BLOCKS / PRESET SPEED  
 APPLICATION BLOCKS / MULTI-FUNCTION 1 to 8  
 APPLICATION BLOCKS / LATCH  
 APPLICATION BLOCKS / FILTER 1, 2  
 APPLICATION BLOCKS / BATCH COUNTER  
 APPLICATION BLOCKS / INTERVAL TIMER  
 APPLICATION BLOCKS / COMPARATOR 1 to 4  
 APPLICATION BLOCKS / C/O SWITCH

### 12.1 General rules

#### 12.1.1 Sample times

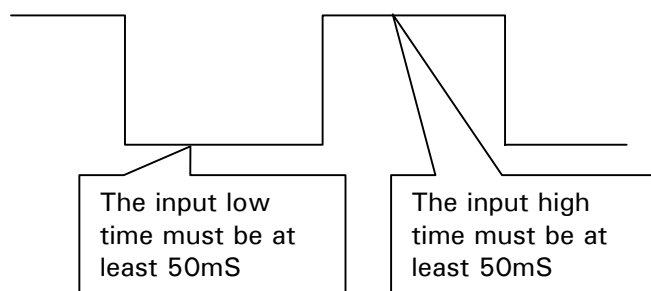

When application blocks are being processed the workload on the internal microprocessor is increased.

With no application blocks activated the time taken to perform all the necessary tasks (cycle time) is approximately 5mS.

With **all** the application blocks activated the cycle time is approximately 10mS. In the future the designers expect to add even more application blocks. It is not

expected however that the typical cycle time will ever be greater than 30mS. (Bear in mind that it would be highly unusual for all the application blocks to be activated). With this in mind it is recommended that the system designer takes care that external logic signals are stable long enough to be recognised. In order to achieve this, the logic input minimum dwell time has been specified at 50mS. However it will of course be possible to operate with much lower dwell times than this for specific installations where the cycle time is low. There is then however the risk that a future re-configuration of the blocks by the user would increase the cycle time sufficiently to cause sampling problems.

#### 12.1.2 Order of processing

It may be useful for system designers to know the order in which the blocks are processed within each cycle.

0) Analogue inputs	12) Torque compensator
1) Motorised pot	13) Zero interlocks
2) Digital inputs	14) Speed control
3) Reference exchange	15) Preset speed
4) Jumpers	16) Parameter profile
5) Multi-function	17) Latch
6) Alarms	18) Batch counter
7) PID1, 2	19) Interval timer
8) Summer 1, 2	20) Filters
9) Run mode ramps	21) Comparators
10) Diameter calc	22) C/O Switches
11) Taper tension	23) All terminal outputs

### 12.1.3 Logic levels

Logic inputs will recognise the value zero, (any units), as a logic low. All other numbers, including negative numbers, will be recognised as a logic high.

### 12.1.4 Activating blocks

In order to activate a block it is necessary to configure its GOTO window to a PIN other than 400)Block disconnect. In the CONFIGURATION menu first enter the ENABLE GOTO, GETFROM window and set it to ENABLED. Then staying in the CONFIGURATION menu proceed to BLOCK OP CONFIG to find the appropriate GOTO. After completing the connection return to the ENABLE GOTO, GETFROM window and set it to DISABLED.

#### 12.1.4.1 Conflicting GOTO connections

When the ENABLE GOTO, GETFROM window is set it to DISABLED, the system will undertake an automatic conflict check. If it has found that there are 2 or more GOTOs connected to the same PIN, it will issue the alarm GOTO CONFLICT.

Proceed to 13.14 CONFLICT HELP MENU in CONFIGURATION to find the number of conflicting GOTO connections, and the target PIN that causes the conflict. One of the GOTO connections must be removed to avoid the conflict.

This process is repeated until there are no conflicts.

Note that this tool is extremely helpful. Without it there is the possibility that user GOTO configuration errors would cause multiple values to alternately appear at the conflict PIN resulting in unusual system behaviour.

#### 12.1.4.2 Application blocks PIN table

The application blocks start at PIN 401 and continue up to approximately PIN 670. There is a complete numeric PIN table for these in the separate application blocks manual.

## 13 CONFIGURATION

<b>13 CONFIGURATION</b> .....	<b>167</b>
13.1 CONFIGURATION menu.....	168
13.1.1 PL PILOT configuration tool .....	168
13.2 Configurable connections.....	169
13.2.1 Key features of GOTO window .....	170
13.2.2 Key features of GET FROM window.....	170
13.2.3 Summary of GOTO and GET FROM windows.....	171
13.2.4 JUMPER connections.....	171
13.2.5 Block Disconnect PIN 400 .....	171
13.2.6 Hidden parameters .....	171
13.2.7 CONFIGURATION / ENABLE GOTO, GETFROM .....	172
13.3 CONFIGURATION / UNIVERSAL INPUTS.....	172
13.3.1 UNIVERSAL INPUTS / Block diagram .....	174
13.4 CONFIGURATION / ANALOG OUTPUTS.....	178
13.4.1 ANALOG OUTPUTS / AOP4 Iarm output rectify enable PIN 250 .....	178
13.4.2 ANALOG OUTPUTS / AOP1/2/3/4 SETUP .....	178
13.4.3 ANALOG OUTPUTS / Scope output select PIN 260.....	180
13.5 CONFIGURATION / DIGITAL INPUTS.....	180
13.5.1 Using DIP inputs for encoder signals.....	180
13.5.2 DIGITAL INPUTS / DIPX SETUP.....	181
13.5.3 DIGITAL INPUTS / RUN INPUT SETUP .....	182
13.6 CONFIGURATION / DIGITAL IN/OUTPUTS.....	183
13.6.1 DIGITAL IN/OUTPUTS / DIOX SETUP.....	183
13.7 CONFIGURATION / DIGITAL OUTPUTS.....	186
13.7.1 DIGITAL OUTPUTS / DOPX SETUP.....	186
13.8 CONFIGURATION / STAGING POSTS .....	188
13.8.1 Connecting PINs with different units.....	189
13.8.2 STAGING POSTS / Digital / analog 1/2/3/4 PINs 296 to 303.....	190
13.9 CONFIGURATION / SOFTWARE TERMINALS.....	191
13.9.1 SOFTWARE TERMINALS / Anded run PIN 305 .....	191
13.9.2 SOFTWARE TERMINALS / Anded jog PIN 306 .....	191
13.9.3 SOFTWARE TERMINALS / Anded start PIN 307 .....	192
13.9.4 SOFTWARE TERMINALS / Internal run input PIN 308.....	192
13.10 CONFIGURATION / JUMPER CONNECTIONS.....	193
13.10.1 JUMPER CONNECTIONS / Make jumper GET FROM source connection .....	193
13.10.2 JUMPER CONNECTIONS / Make jumper GOTO destination connection .....	193
13.11 CONFIGURATION / BLOCK OP CONFIG .....	194
13.11.1 BLOCK OP CONFIG / Block outputs GOTO.....	195
13.11.2 Other GOTO windows.....	195
13.12 CONFIGURATION / FIELDBUS CONFIG .....	195
13.13 CONFIGURATION / DRIVE PERSONALITY .....	196
13.13.1 DRIVE PERSONALITY / PASSIVE MOTOR SET .....	196
13.13.2 DRIVE PERSONALITY / Recipe page PIN 677 .....	197
13.13.3 DRIVE PERSONALITY / Maximum current response PIN 678 .....	198
13.13.4 DRIVE PERSONALITY / Armature current burden resistance PIN 680.....	198
13.14 CONFLICT HELP MENU .....	201
13.14.1 CONFLICT HELP MENU / Number of conflicts.....	201
13.14.2 CONFLICT HELP MENU / Multiple GOTO conflict PIN identifier .....	201

### 13.1 CONFIGURATION menu

PIN numbers used 250 to 399.



There are 720 parameters each with a unique PIN that is used in the process of configuration. The PINs identify connection points during configuration and can store values.

**CONNECTIONS.** It is possible to construct complex systems by making connections to PINs. There are 2 connection tools available. These are GOTOs and GET FROMs. When a parameter is given a value by the programming procedure, or is using its default value, it is important to understand how it is affected **after** connection to another source using the GOTO function. **In this case the value is solely determined by the source.** The parameter can be used as a diagnostic monitor of that source.

If the connection from the source is then removed, the default or desired value of the target must be re-entered and saved via the keys or PL PILOT.

**APPLICATION BLOCKS** from the applications menu are normally dormant. Connecting the output of a block, using its GOTO, to a PIN other than 400, activates it.

See also 10.2.5 Parameter exchange using ASCII COMMS and 10.2.5.1 PL PILOT and SCADA (System Control And Data Acquisition) package.

#### 13.1.1 PL PILOT configuration tool

PL PILOT, a self installing PC based graphical configuration, monitoring and recipe manipulation tool, which allows fast and easy adjustment, is supplied with the unit on a CD. It may also be used for up to 10 PL/Xs on one multidrop serial link. There is a suitable cable supplied to connect the PC COM 1 serial port to PL/X RS232 PORT1.

187)PORT1 BAUD RATE. Set it to 19200 on the target PL/X, and in 'Options' / 'Setup COM Port' in PL PILOT.

188)PORT1 FUNCTION. Set it to ASCII COMMS on the target PL/X. PL PILOT can configure and monitor. See 10.1.4 How to use USB ports and 10.2.5.1 PL PILOT and SCADA (System Control And Data Acquisition) package. For PL PILOT version compatibility see 5.1.7 Finding the software version number of the unit. See also 5.3 Archiving PL/X recipes.

Note. PILOT is not subject to PASSWORD control. See 11.2 DISPLAY FUNCTIONS / PASSWORD CONTROL.

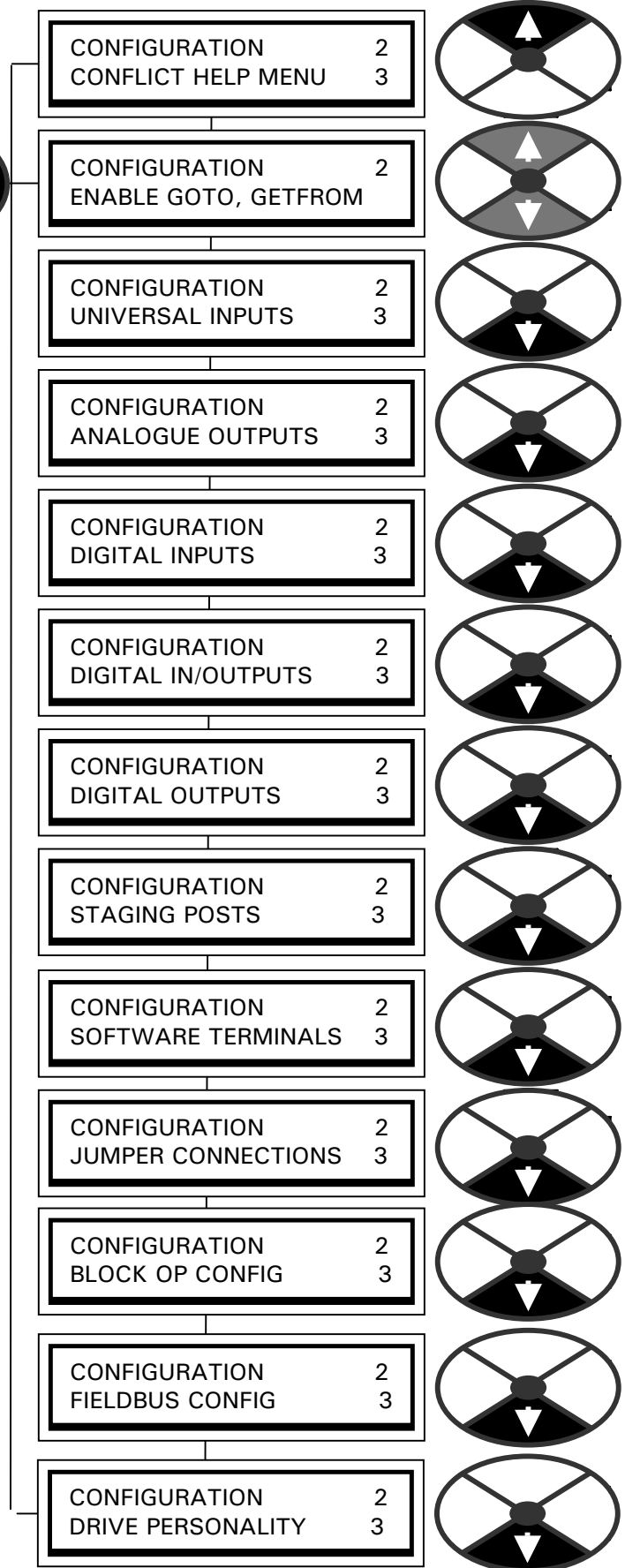



### 13.2 Configurable connections

The internal connections within the PL/X may be re-configured using the display and keys, or PL PILOT.

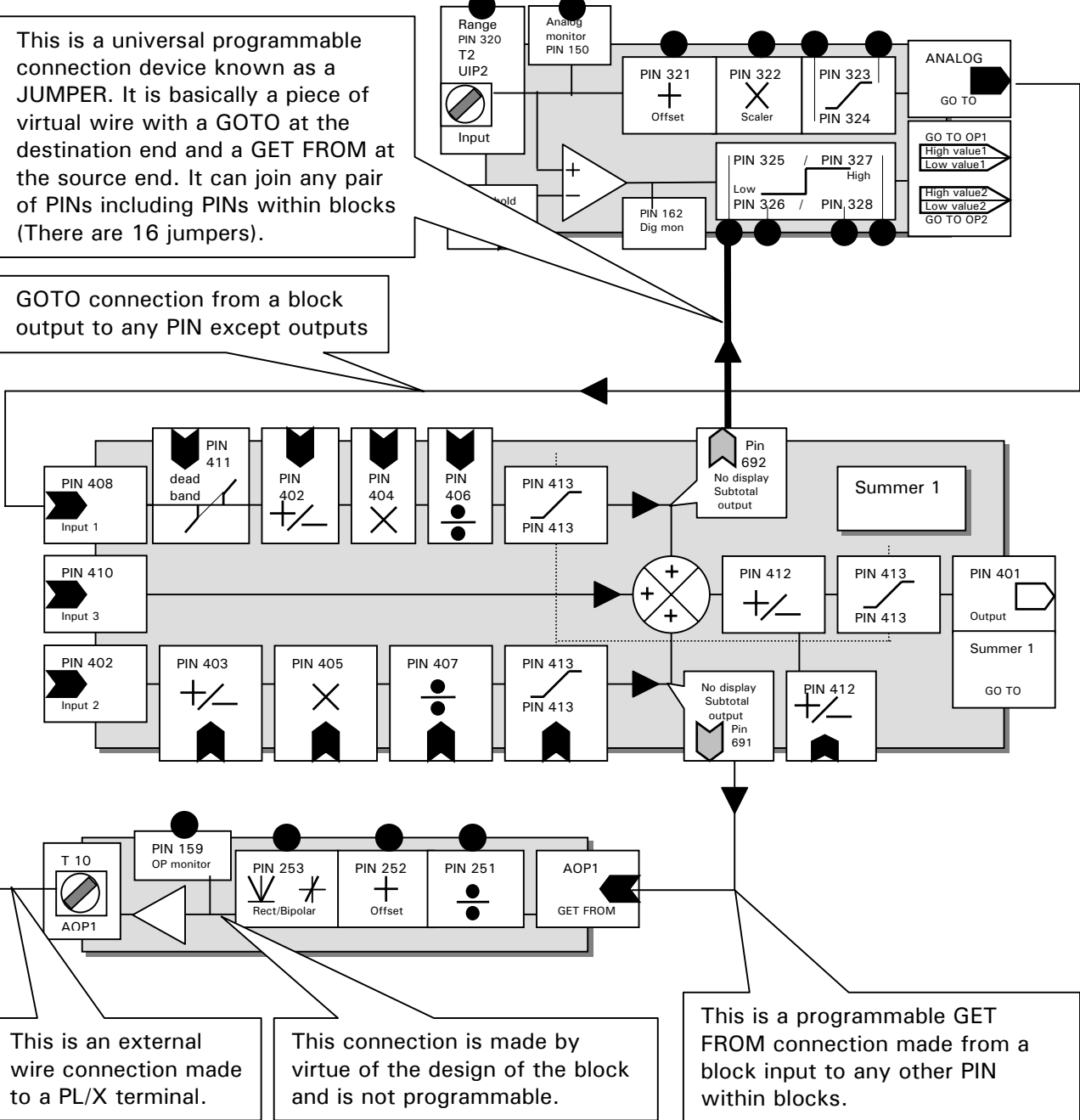

**Note. To start a connection configuration session ENABLE GOTO, GETFROM must be set to ENABLED.** The PL/X possesses a versatile range of pre-designed BLOCKS. Signals need to be routed to the inputs of the blocks, processed inside the block, then routed from the output to the desired destination. Examples of blocks are a signal summer and a universal terminal input. There are 2 types of connection tool which can be programmed by the user called GOTO and GET FROM. It is not possible to make illegal connections e. g. from output to output. It is possible however to connect more than 1 GOTO to a legal pin (eg an input) and this would result in an error at the target PIN. The PL/X has a conflict checker which warns of GOTO connection conflicts after configuration. (When the user sets ENABLE GOTO, GETFROM to DISABLED). See 13.14 CONFLICT HELP MENU. See also 13.8.1 Connecting PINs with different units.

**Note. To end a connection configuration session ENABLE GOTO, GETFROM must be set to DISABLED.**

Note. It is not possible to connect a GOTO directly to a GETFROM. To do this first connect the GOTO to a STAGING POST (or other unused PIN), then connect the GETFROM to the same STAGING POST.

13.2.1 Key features of GOTO window

**Note.** To start a connection configuration session **ENABLE GOTO**, **GETFROM** must be set to **ENABLED**.

**Note.** To end a connection configuration session **ENABLE GOTO**, **GETFROM** must be set to **DISABLED**.

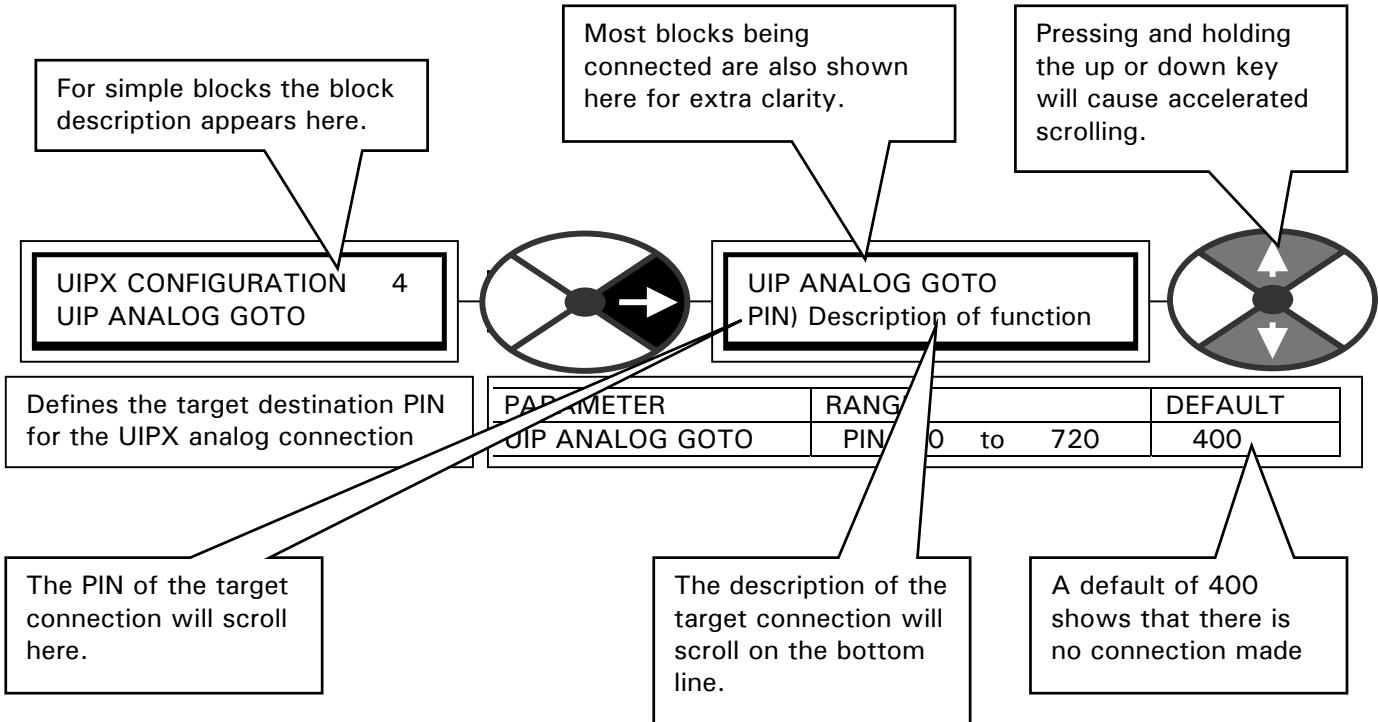

13.2.2 Key features of GET FROM window

**Note.** To start a connection configuration session **ENABLE GOTO**, **GETFROM** must be set to **ENABLED**.

**Note.** To end a connection configuration session **ENABLE GOTO**, **GETFROM** must be set to **DISABLED**.

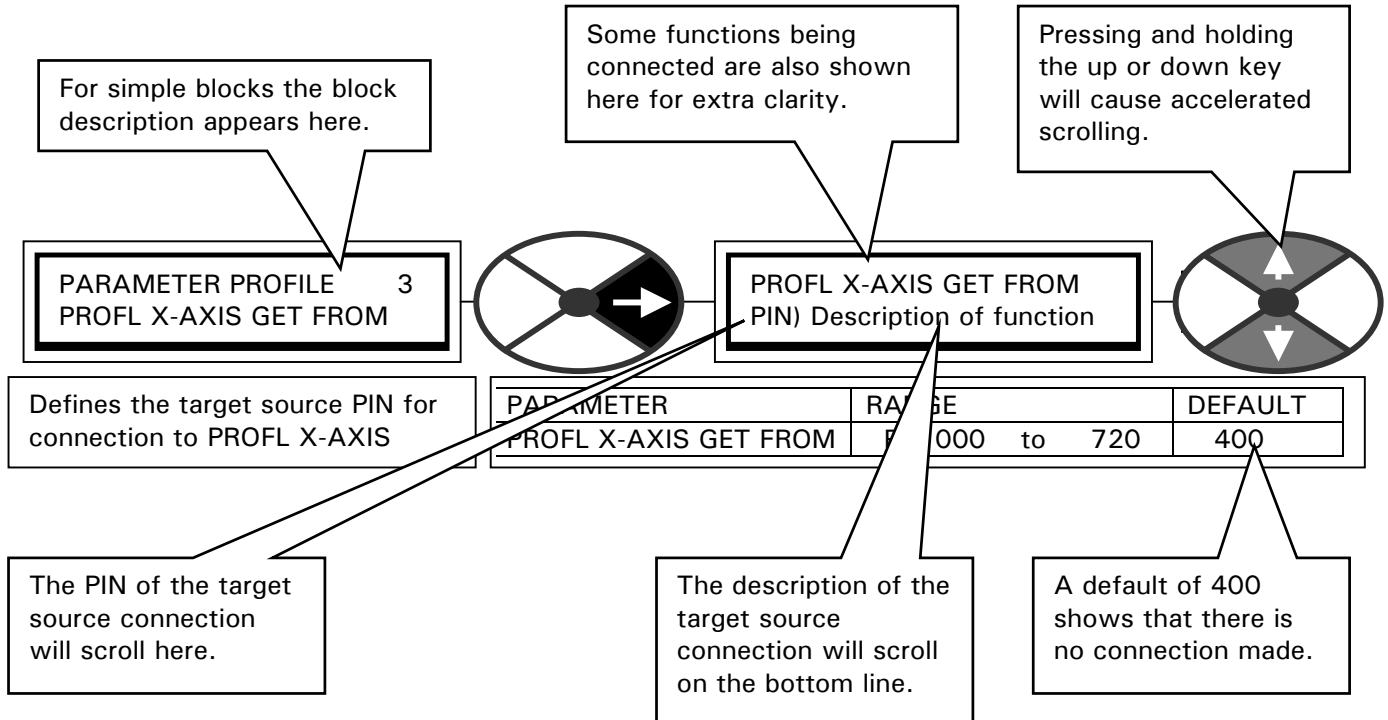

### 13.2.3 Summary of GOTO and GET FROM windows

**Note. To start a connection configuration session ENABLE GOTO, GETFROM must be set to ENABLED.**

**Note. To end a connection configuration session ENABLE GOTO, GETFROM must be set to DISABLED.**

The above ENABLE / DISABLE is done automatically when working from the PL PILOT configuration tool).

These windows make configuration connections really fast and simple. You do not have to work with lists of numbers and undecipherable codes in order to make connections.

The UP/DOWN keys have an accelerating action for rapid arrival at the desired target.

The block PINs are arranged in adjacent groups. You only need to know one PIN in the target block to easily find all the others. Alternatively, just scroll through any GETFROM window, from one end to the other, to see all the PINs with their descriptions, or use the PIN table at the back of each manual.

The description of the target connection is usually unambiguous. E.g. there are many PROPORTIONAL GAINS within the drive that can be accessed, but all are preceded with an indication of their block location. This can usually be read even if you are scrolling at high speed.

The GOTO window automatically skips over illegal connections, e.g. other outputs. If more than one GOTO connection is accidentally made to any PIN, then the conflict checker will warn, and assist, in finding the PIN.

Note. It is not possible to connect a GOTO directly to a GETFROM. To do this first connect the GOTO to a STAGING POST (or other unused PIN), then connect the GETFROM to the same STAGING POST.

**Remember, when a GOTO connection is made, the target parameter can not be adjusted using the keys. Its value is determined by the source of the GOTO connection. It becomes a value monitor for the GOTO.**

**If the connection from the source is then removed, the default or desired value of the target must be re-entered and saved via the keys or PL PILOT.**

### 13.2.4 JUMPER connections

There are 16 virtual wires called JUMPER1-16 with a GOTO at the output end, and a GETFROM at the input. JUMPER connections can join any legal pair of PINs including outputs, inputs, and PINs within blocks. GOTO to output connections are automatically avoided. The GETFROM end can also connect onto PINs that have already been connected using a GOTO or GETFROM, allowing the fan out of an output for example.

(The JUMPER1-16 nomenclature is also independently used in 13.12 CONFIGURATION / FIELD BUS CONFIG).

Up to 16 JUMPER connections are available. The 8 MULTI-FUNCTION blocks may also be used as jumpers. See the applications manual for a description of these blocks.

Each JUMPER is identified by a number and possesses its own configuration menu. In the menu is a GOTO window and a GET FROM window to define the connections.

A JUMPER is a special class of connection that is normally reserved for making parallel connections or connections to the interior PINs inside blocks. If a JUMPER is used to connect an APPLICATION block output, it is not able to activate the block. This is only possible using the block GOTO connection, which is found within the BLOCK OP CONFIG menu. See also 13.8 CONFIGURATION / STAGING POSTS.

### 13.2.5 Block Disconnect PIN 400

When you enter the GOTO or GETFROM windows the starting point is approximately midway at PIN 400)Block Disconnect. This enables rapid access to either end of the range.

APPLICATION blocks are located above 400, and DRIVE control loop blocks below.

Connecting within a GOTO window of a block to a PIN other than 400 will activate the block. Conversely connecting to 400 will de-activate the block.

### 13.2.6 Hidden parameters

There are a small number of parameters that are available for connection, but not provided with an adjustment display window in the menu tree. For example unfiltered or rectified versions of displayed parameters. They are all grouped together in the PIN table from 720 downwards. They are also shown on the relevant block diagrams with a grey IO arrow instead of a black arrow. The PIN number and description of these hidden parameters appears as normal when using the GOTO or GET FROM windows.

13.2.7 CONFIGURATION / ENABLE GOTO, GETFROM

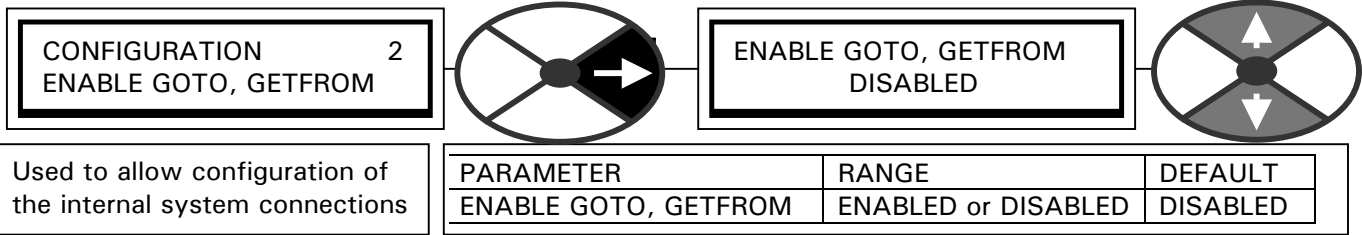

Used to allow configuration of the internal system connections

**Note.** To start a connection configuration session **ENABLE GOTO, GETFROM** must be set to **ENABLED**.  
**Note.** To end a connection configuration session **ENABLE GOTO, GETFROM** must be set to **DISABLED**.

When the window is set to **DISABLED** the automatic conflict checker starts checking to see if more than one GOTO connection has been made to any PIN (More than one GOTO would lead to a unwanted values at the target PIN). If it finds a conflict, the alarm message **GOTO CONFLICT** will appear on the bottom line. To help find the conflict. See 13.14 **CONFLICT HELP MENU**.

13.3 CONFIGURATION / UNIVERSAL INPUTS

Pin numbers 320 to 399

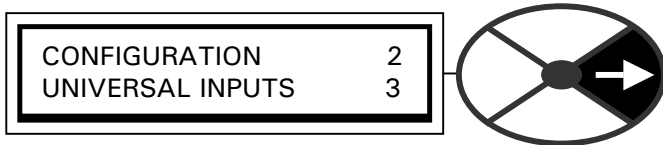

The PL/X series not only possesses 8 analogue inputs, but also measures all of these to high resolution with excellent response time. In addition it is possible to program the voltage range of each input to +/- (5/10/20/30V). This allows signals other than 10V full scale to be used, and enables the input to be used as a sophisticated digital input. This can be achieved for example, by programming the input to the 30V range and selecting the programmable logic threshold at 15V, to recognise a 0 or 1.

Each input has 3 outputs, a linear output and a dual logic output. They operate simultaneously.

UIP3 is specially adapted to acquire signals with a faster response than the others and is therefore used for input to the speed/current loop that requires a fast response.

There is a permanent internal connection to the speed/current loop from UIP3 to 64)SPEED REF 3 MON. The linear GOTO of UIP3 is operative independantly of the internal connection to the speed/current loop. (Note. The GOTO may be left configured to 400)Block Disconnect, if the internal connection is utilised). To connect UIP3 elsewhere, nullify the internal connection, (set 67)SPD/CUR RF3 RATIO in the SPEED REF SUMMER menu to 0.0000), then reconfigure the linear GOTO. The parameter 64)SPEED REF 3 MON is a monitor of the UIP3 analog output.

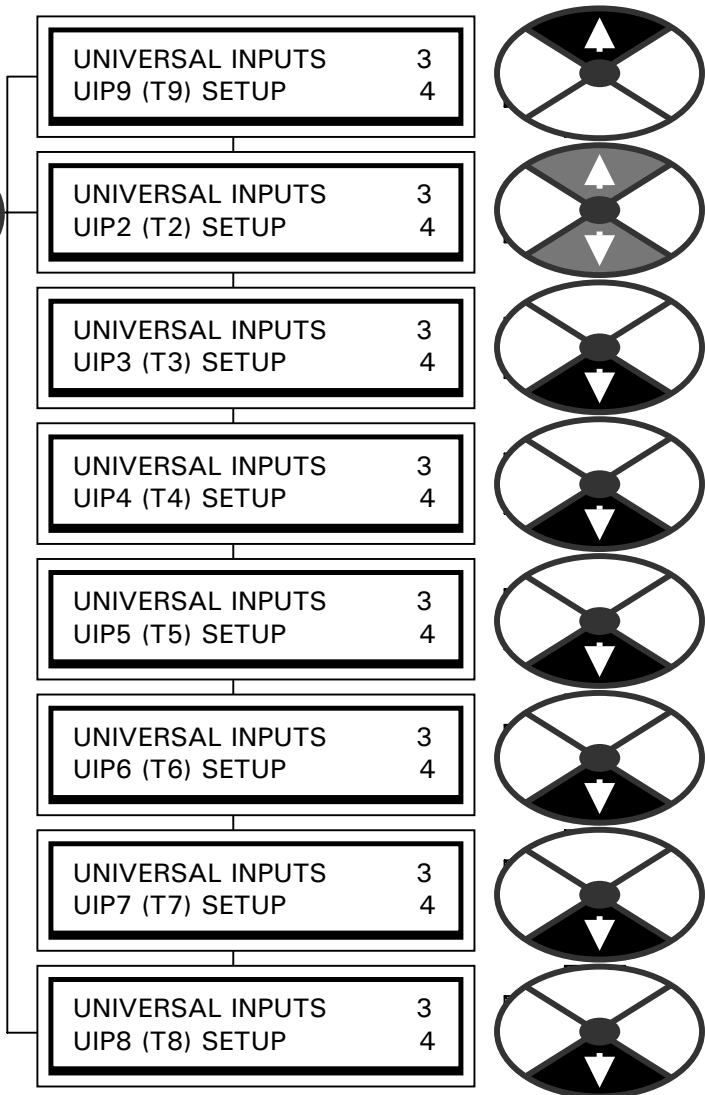

UNIVERSAL INPUTS / UIP2 to 9  
This shows the UIP2 submenu

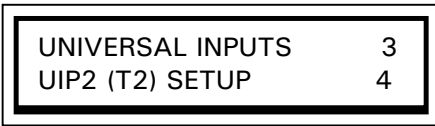

There are 8 sub menus, one for each input 2 to 9

Each input terminal UIP2 to 9 is provided with its own processing block with a linear and logic output. It allows the following functions.

- Range selectable +/- (5, 10, 20, 30V).
- Linear functions.
- Linear offset.
- Signed scaling.
- Clamping of the linear output.

- Logic functions.
- Adjustable threshold for logic level detection.
- The comparator output is a low or a high. The high state results in the HI VALUE being output. The low state results in the LO VALUE output.
- Note. UIPs offer good noise immunity.**

The LO and HI values can be entered using the display and keys, or may be connected from other PINs using JUMPERS. This turns the function into a change-over switch for dynamic values.

There are 2 sets of value for high and value for low windows each pair having its own GOTO connection facility. This allows 2 independent output values for a logic high input and 2 independent output values for a logic low input. This facility allows versatile parameter changeover functions to be selected by a single input. E.g. DIG OP1 GOTO value change to target PIN x, DIG OP2 simultaneous logic change to target PIN y.

For logic only usage a value of 0.00% is read as a low. Any non zero +/- value is read as a high. Logic inversion is accomplished by entering 0.00% in the value for HI window and 0.01% in the value for LO window.

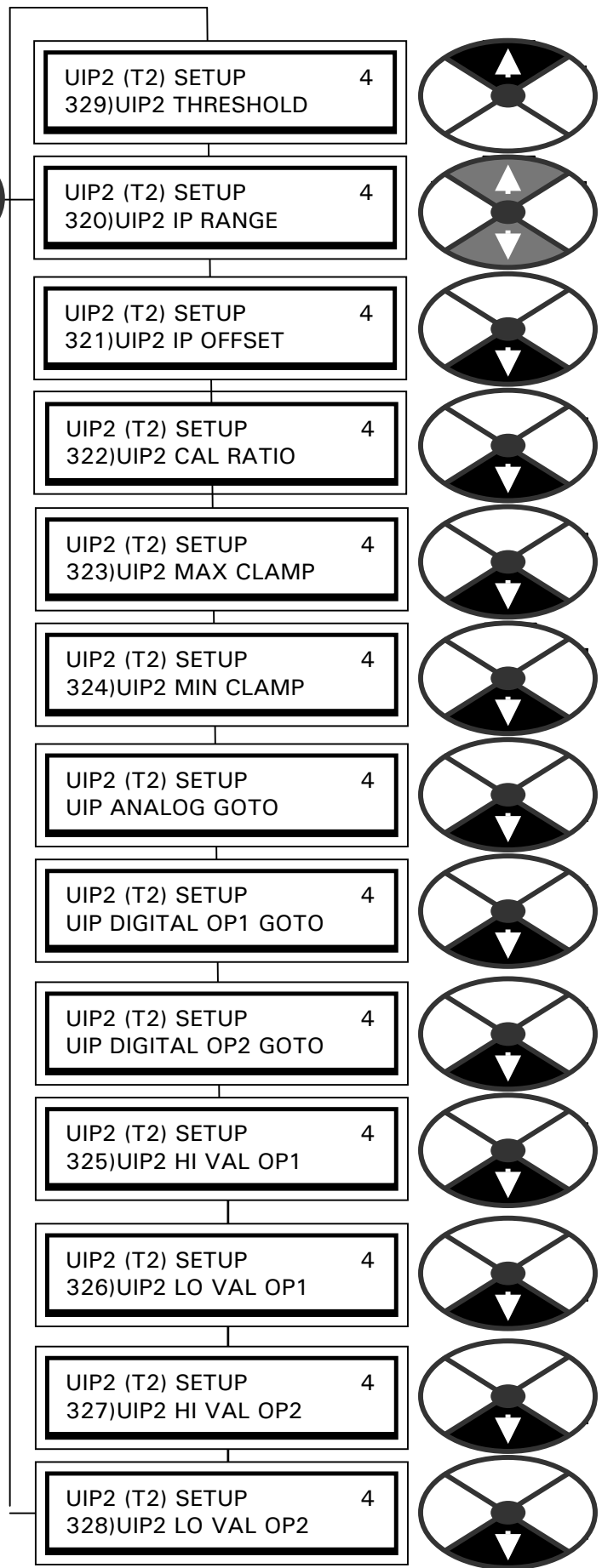
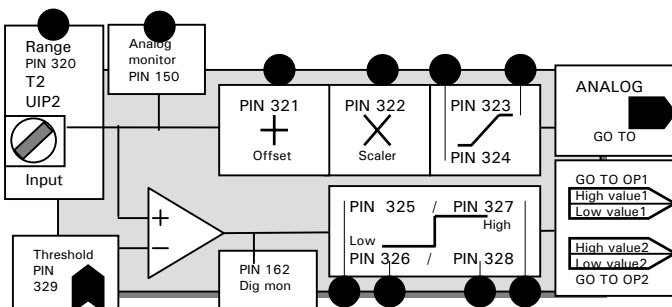

13.3.1 UNIVERSAL INPUTS / Block diagram

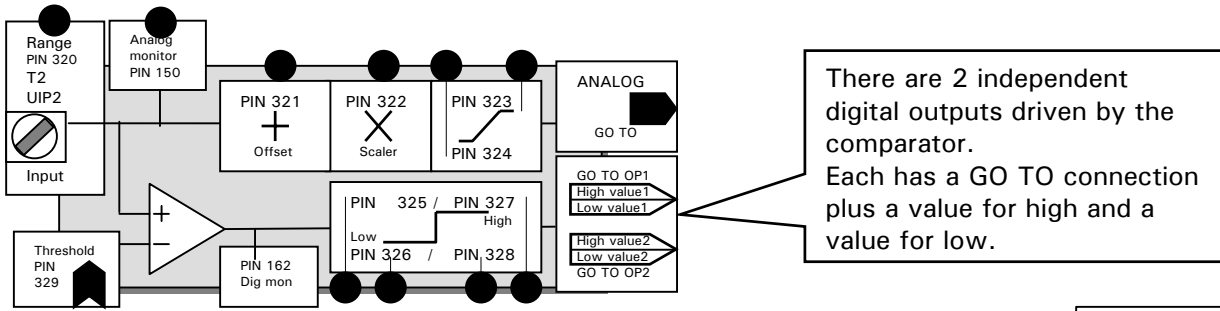

There are 2 independent digital outputs driven by the comparator. Each has a GO TO connection plus a value for high and a value for low.

13.3.1.1 UIPX SETUP / UIP(2) to (9) Input range PIN 3(2)0 to 3(9)0

UIP2 (T2) SETUP 4  
320)UIP2 IP RANGE

320)UIP2 IP RANGE 0

Sets the 0 to +/-100% voltage range of the UIPX input signal

PARAMETER	RANGE	DEFAULT	PIN
UIP2 IP RANGE	1 = +/-5V, 0 = +/-10V, 2 = +/-20V, 3 = +/-30V	0 = +/-10V	320

This is a code, not a voltage

The +/-5V and +/-10V ranges are the most accurate (0.4%, typically 0.1%).

The +/-20V and +/-30V ranges use resistor divider networks and the absolute accuracy is 4%. Also, if the same signal is used externally elsewhere, then it is important that the source impedance of the signal connected to the terminal is as low as possible. This is because as the PL/X scans the inputs, the input impedance will vary between 100K and 50K for these ranges. A source of signal with a high input impedance will be affected by the change in input resistance. This will not affect the accuracy of the reading within the PL/X, but may cause an external measurement by another instrument to vary. It is important to remember this when commissioning, as readings at the control terminals with a voltmeter may show slight variations if the source impedance is high. The 5V and 10V ranges are not affected by source impedance.

13.3.1.2 UIPX SETUP / UIP(2) to (9) Input offset PIN 3(2)1 to 3(9)1

UIP2 (T2) SETUP 4  
321)UIP2 IP OFFSET

321)UIP2 IP OFFSET 0.00%

Sets the level of bi-polar offset to be added to the input signal

PARAMETER	RANGE	DEFAULT	PIN
UIP2 IP OFFSET	+/- 100.00%	0.00%	321

Note. 100% represents the full scale voltage of the selected range. E. g. for a -1V offset to a signal using the 5V range enter the value -20.00%. The offset is added or subtracted prior to the scaling function. This offset does not affect the signal used for the digital threshold comparison.

13.3.1.2.1 4-20mA loop input SETUP

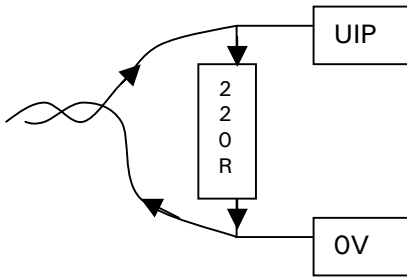

When using 4-20mA loop signals all that is required is to fit an external burden resistor of 220 Ohms between the input and 0V. The resulting voltage signal generated by passing the signal current through the burden will be +0.88V for 4 mA (represents 0%) and 4.4V for 20mA (represents 100%). Using the appropriate UIPX SETUP block, select the following :-  
 5V range (Max voltage generated by loop across burden = 4.4V)  
 -17.6% offset (4mA gives 0.88V which is 17.6% of 5V)  
 1.420 scaling factor ((4.4 - 0.88) X 1.420 = 5V i.e 100%)  
 For burden resistors of other values, the range, offset and scale will differ accordingly.

13.3.1.3 UIPX SETUP / UIP(2) to (9) Linear scaling ratio PIN 3(2)2 to 3(9)2

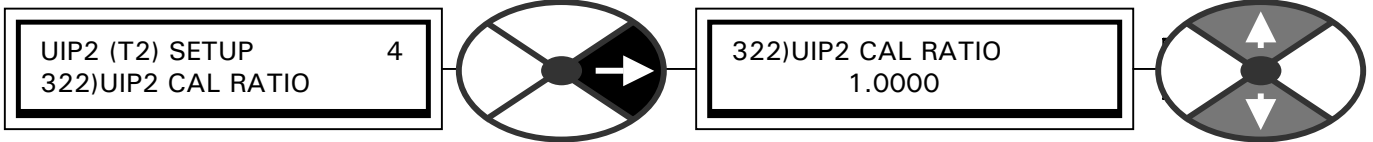

Allows linear scaling of the signal on the UIPX input.

PARAMETER	RANGE	DEFAULT	PIN
UIP2 CAL RATIO	+/- 3.0000	1.0000	322

Note. This does not affect the signal used for the digital threshold comparison. This scaling factor may be used to introduce an inversion by selecting a negative number. A scaling factor of 1.0000 is equivalent to 100.00%. In this case the full range of the input as selected in the range selection window will be equivalent to a 100.00% signal. E. g. With the 30V range selected and a scaling factor of 1.0000, then a signal of 30V would represent a demand of 100.00% speed.

13.3.1.4 UIPX SETUP / UIP(2) to (9) Maximum clamp level PIN 3(2)3 to 3(9)3

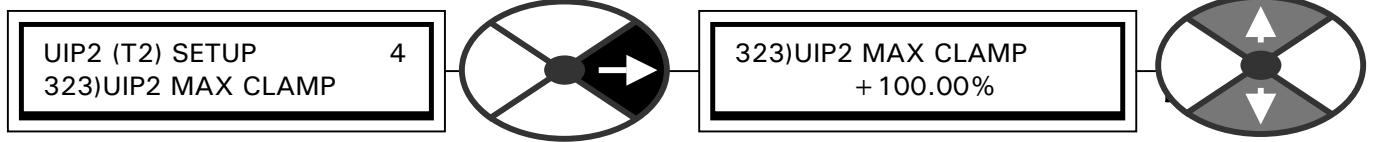

Sets an upper clamp level for the scaled linear input signal.

PARAMETER	RANGE	DEFAULT	PIN
UIP2 MAX CLAMP	+/- 300.00%	+ 100.00%	323

13.3.1.5 UIPX SETUP / UIP(2) to (9) Minimum clamp level PIN 3(2)4 to 3(9)4

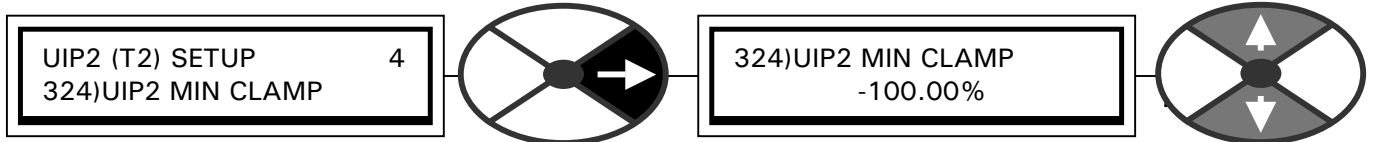

Sets a lower clamp level for the scaled linear input signal.

PARAMETER	RANGE	DEFAULT	PIN
UIP2 MIN CLAMP	+/- 300.00%	-100.00%	324

13.3.1.6 UIPX SETUP / UIP(2) to (9) Make analog GOTO destination connection

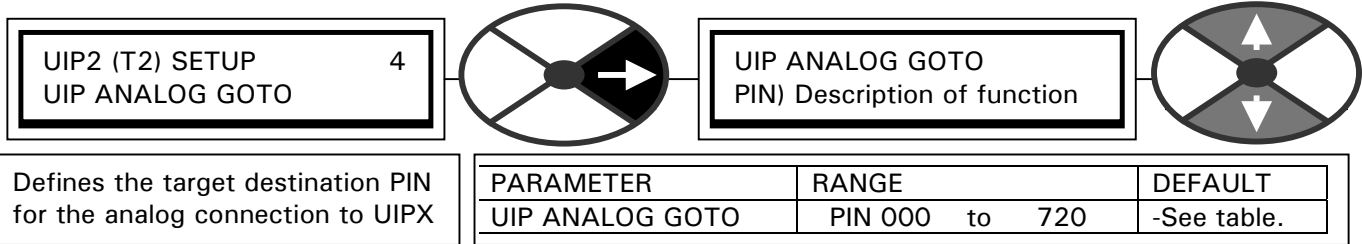

UIPX	Term	Analog GOTO	Default connection name	Default connection
UIP2	2	Analog GOTO	Aux speed reference	PIN 63
UIP3	3	Analog GOTO	Speed reference / Current demand (Fast IP) (Internally connected, not using the GOTO)	PIN 400 (Block disconnect)
UIP4	4	Analog GOTO	Ramp input	PIN 26
UIP5	5	Analog GOTO	Lower current clamp (-ve)	PIN 90
UIP6	6	Analog GOTO	Main current limit/Upper current clamp + ve	PIN 89
UIP7	7	Analog GOTO	Motorised pot preset enable	PIN 400 (Default digital)
UIP8	8	Analog GOTO	Motorised pot up command	PIN 400 (Default digital)
UIP9	9	Analog GOTO	Motorised pot down command	PIN 400 (Default digital)

13.3.1.7 UIPX SETUP / UIP(2) to (9) Make digital output 1 GOTO destination connection

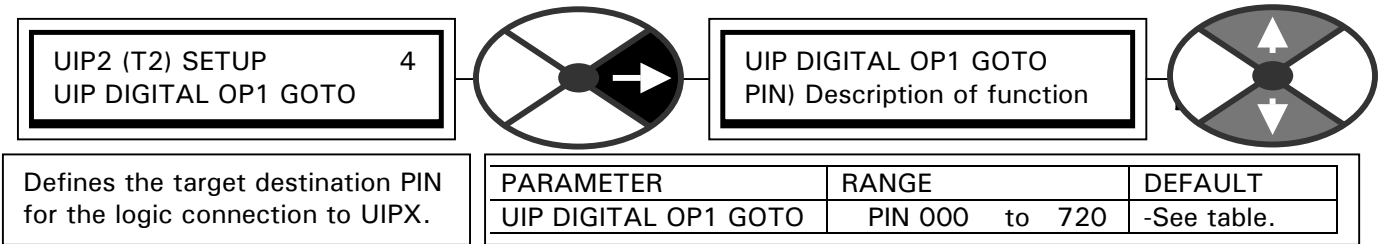

UIPX	Term	Dig OP1 GOTO	Default connection name	Default connection
UIP2	2	Dig OP1 GOTO	Not connected	PIN 400 (Default analog)
UIP3	3	Dig OP1 GOTO	Not connected	PIN 400 (Block disconnect)
UIP4	4	Dig OP1 GOTO	Not connected	PIN 400 (Default analog)
UIP5	5	Dig OP1 GOTO	Not connected	PIN 400 (Default analog)
UIP6	6	Dig OP1 GOTO	Not connected	PIN 400 (Default analog)
UIP7	7	Dig OP1 GOTO	Motorised pot preset enable	PIN 52
UIP8	8	Dig OP1 GOTO	Motorised pot up command	PIN 48
UIP9	9	Dig OP1 GOTO	Motorised pot down command	PIN 49

13.3.1.8 UIPX SETUP / UIP(2) to (9) Make digital output 2 GOTO destination connection

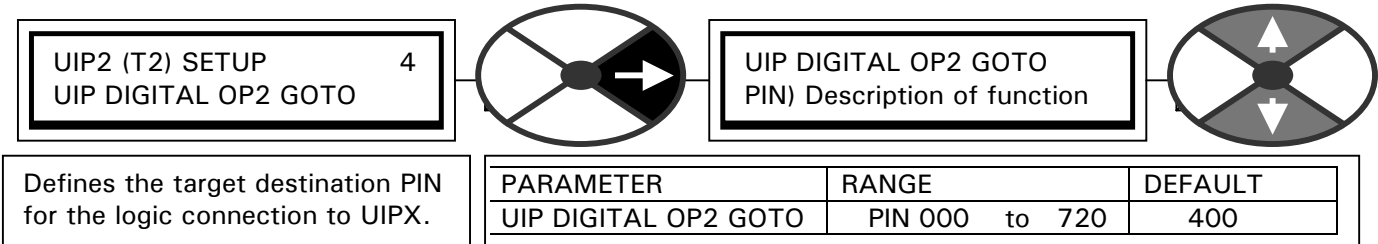

All UIP DIGITAL OP2 GOTO default connections are 400)Block Disconnect.



13.3.1.9 UIPX SETUP / UIP(2) to (9) Digital input, high value for output 1 PIN 3(2)5 to 3(9)5

UIP2 (T2) SETUP 4  
 325)UIP2 HI VAL OP1

325)UIP2 HI VAL OP1  
 0.01%

Sets the OP1 value selected by a high UIPX input.

PARAMETER	RANGE	DEFAULT	PIN
UIP2 HI VAL OP1	+/- 300.00%	0.01%	325

Note. You can make a simple AND gate by selecting this as the target PIN of a logical GOTO.

13.3.1.10 UIPX SETUP / UIP(2) to (9) Digital input, low value for output 1 PIN 3(2)6 to 3(9)6

UIP2 (T2) SETUP 4  
 326)UIP2 LO VAL OP1

326)UIP2 LO VAL OP1  
 0.00%

Sets the OP1 value selected by a low UIPX input.

PARAMETER	RANGE	DEFAULT	PIN
UIP2 LO VAL OP1	+/- 300.00%	0.00%	326

Note. You can make a simple OR gate by selecting this as the target PIN of a logical GOTO.

13.3.1.11 UIPX SETUP / UIP(2) to (9) Digital input, high value for output 2 PIN 3(2)7 to 3(9)7

UIP2 (T2) SETUP 4  
 327)UIP2 HI VAL OP2

327)UIP2 HI VAL OP2  
 0.01%

Sets the OP2 value selected by a high UIPX input.

PARAMETER	RANGE	DEFAULT	PIN
UIP2 HI VAL OP2	+/- 300.00%	0.01%	327

Note. You can make a simple AND gate by selecting this as the target PIN of a logical GOTO.

13.3.1.12 UIPX SETUP / UIP(2) to (9) Digital input, low value for output 2 PIN 3(2)8 to 3(9)8

UIP2 (T2) SETUP 4  
 328)UIP2 LO VAL OP2

328)UIP2 LO VAL OP2  
 0.00%

Sets the OP2 value selected by a low UIPX input.

PARAMETER	RANGE	DEFAULT	PIN
UIP2 LO VAL OP2	+/- 300.00%	0.00%	328

Note. You can make a simple OR gate by selecting this as the target PIN of a logical GOTO.

13.3.1.13 UIPX SETUP / UIP(2) to (9) Threshold PIN 3(2)9 to 3(9)9

UIP2 (T2) SETUP 4  
 329)UIP2 THRESHOLD

329)UIP2 THRESHOLD  
 6.000 VOLTS

Sets the threshold to determine the logic high/low for UIPX.

PARAMETER	RANGE	DEFAULT	PIN
UIP2 THRESHOLD	+/- 30.000 V	6.000 V	329

E. g. If the range input is set to 20 or 30V, then a threshold of 15.000 V will cause the output to go high for signals greater than + 15.000V and low for signals less than or equal to + 15.000V. The threshold is algebraic. Hence a threshold of -1.000 V will give a high for an input of -0.999 V.

### 13.4 CONFIGURATION / ANALOG OUTPUTS

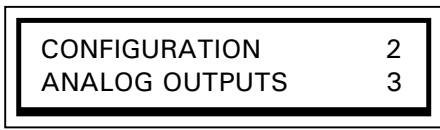

PINs used 250 to 260

There are 4 analogue outputs.

3 programmable and 1 committed to output the armature current signal.

AOP1/2/3 Programmable output specification.  
 12 bit plus sign resolution (2.5mV steps).  
 Short circuit protection to 0V. (Protection is only available for any one output. More than 1 OP shorted may damage the unit).  
 Output current +/-5mA maximum.  
 Output range 0 to +/-11.300V. (10V normally represents 100%).

#### 13.4.1 ANALOG OUTPUTS / AOP4 Iarm output rectify enable PIN 250

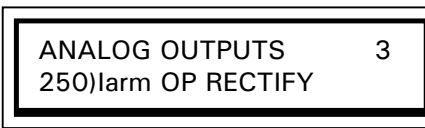
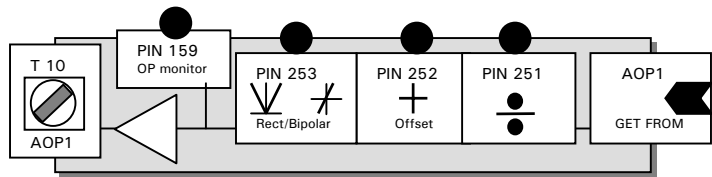

Sets Iarm output (T29) to be either bi-polar or rectified.

ANALOG OUTPUTS 3  
 250)Iarm OP RECTIFY

250)Iarm OP RECTIFY  
 DISABLED

PARAMETER	RANGE	DEFAULT	PIN
Iarm OP RECTIFY	ENABLED or DISABLED	DISABLED	250

#### 13.4.2 ANALOG OUTPUTS / AOP1/2/3/4 SETUP

There are 3 menus, 1 for each analogue output. This list shows AOP1

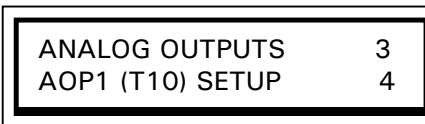

The signal to be output is obtained from the internal system using the GET FROM window.

The next process is a signed scaling divider followed by an offset, which may be added or subtracted. The output mode may be selected as either rectified or bi-polar, prior to being placed on the terminal as a linear voltage signal.

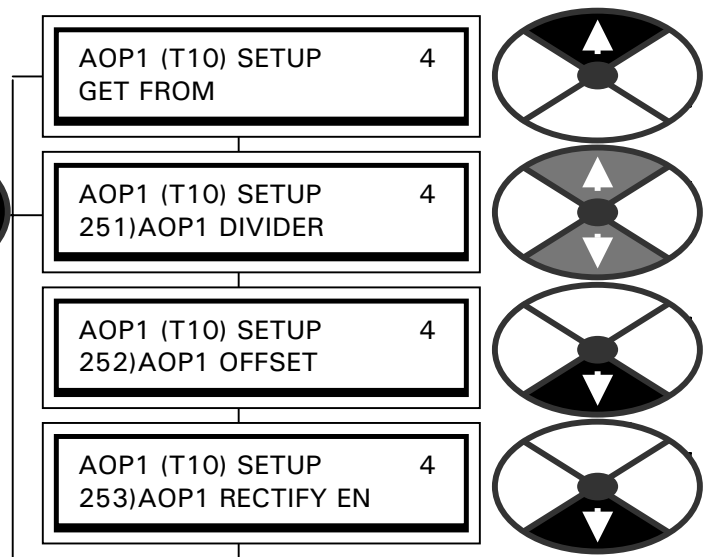
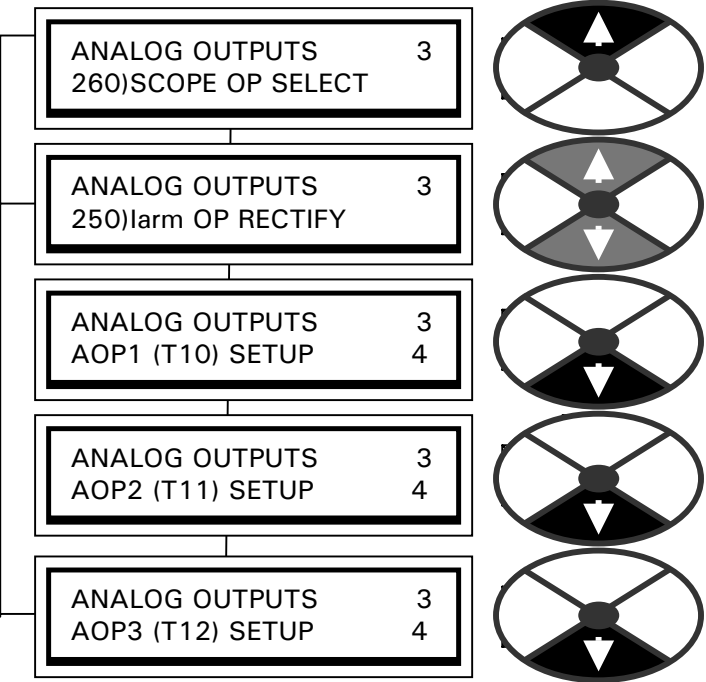

13.4.2.1 AOPX SETUP / AOP1/2/3 Dividing factor PINs 251 / 254 / 257

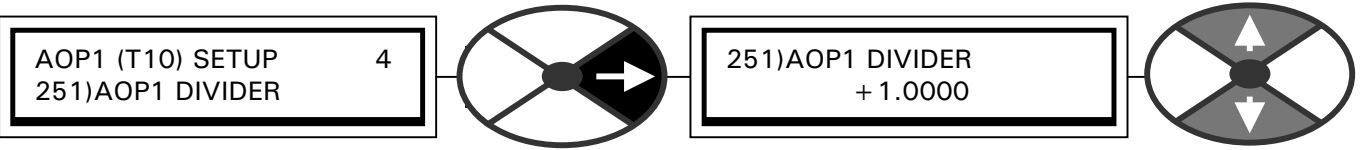

Divides the GET FROM signal source by a signed factor.

PARAMETER	RANGE	DEFAULT	PIN
AOP1 DIVIDER	+/- 3.0000	+1.0000	251

This factor is normally set to provide a maximum amplitude of 10V for the terminal signal voltage. The PL/X default 100.00% voltage is 10.00V. Hence a dividing factor of 1.000 gives 10.00V amplitude for 100.00% signals. This factor is arranged as a divider function to allow high gains if required, by dividing by numbers less than 1.0000. This scaling takes place prior to the addition of an offset in the next window.

13.4.2.2 AOPX SETUP / AOP1/2/3 Offset PINs 252 / 255 / 258

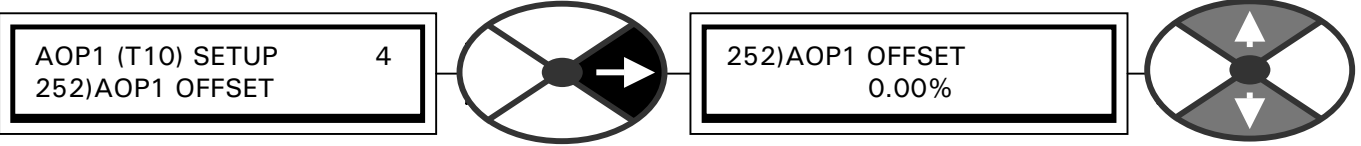

Sets the level of bi-polar offset to be added to the final signal.

PARAMETER	RANGE	DEFAULT	PIN
AOP1 OFFSET	+/- 100.00%	0.00%	252

Note 100.00% is equivalent to 10.00V. Changing the divider factor will not affect the offset value.

13.4.2.3 AOPX SETUP / AOP1/2/3 Rectify mode enable PINs 253 / 256 / 259

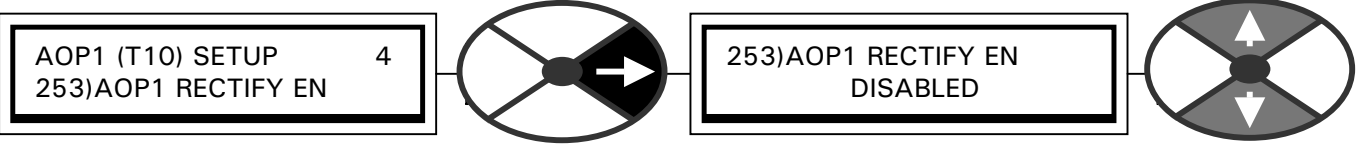

Allows the output mode to be rectified when enabled.

PARAMETER	RANGE	DEFAULT	PIN
AOP1 RECTIFY EN	ENABLED or DISABLED	DISABLED	253

13.4.2.4 AOPX SETUP / AOP1/2/3 Make output GET FROM source connection

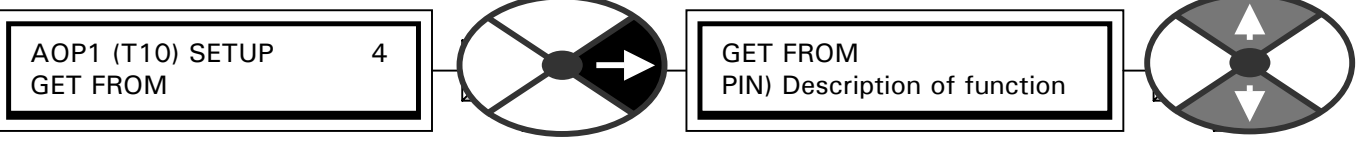

Defines the source PIN for the connection to AOPX.

PARAMETER	RANGE	DEFAULT
GET FROM	PIN 000 to 720	See 13.4.2.5

13.4.2.5 Default connections for AOP1/2/3

AOPX	Function	Terminal	GET FROM
AOP1	Unfiltered total speed feedback	T10	PIN 715
AOP2	Unfiltered total speed reference	T11	PIN 123
AOP3	Unfiltered armature current demand	T12	PIN 718

Note. The function 260)SCOPE OP SELECT described below uses AOP3. Any internal GETFROM connection made to AOP3 is left intact but ignored by 260)SCOPE OP SELECT function.

13.4.3 ANALOG OUTPUTS / Scope output select PIN 260

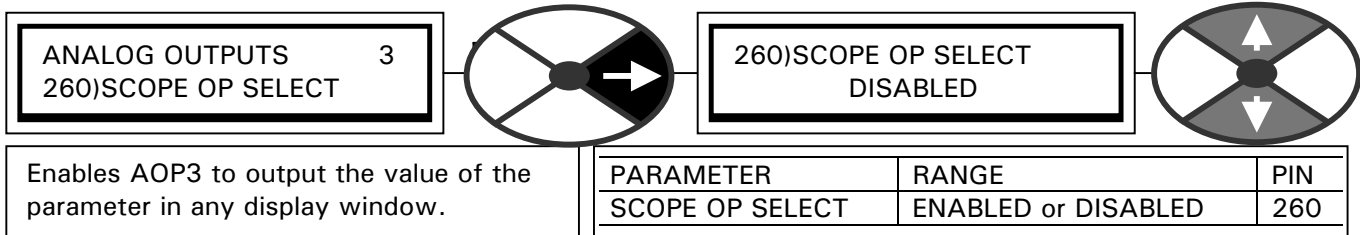

The signal output is automatically switched to the displayed parameter, and provides a linear signed signal. The output scale may be changed by using 257)AOP3 DIVIDER (default 100% gives 10V). This allows very rapid selection of the signal source for display on an oscilloscope.

Note. Any internal GETFROM connection made to AOP3 is left intact but ignored by 260)SCOPE OP SELECT function.

13.5 CONFIGURATION / DIGITAL INPUTS

Pins 310 to 319

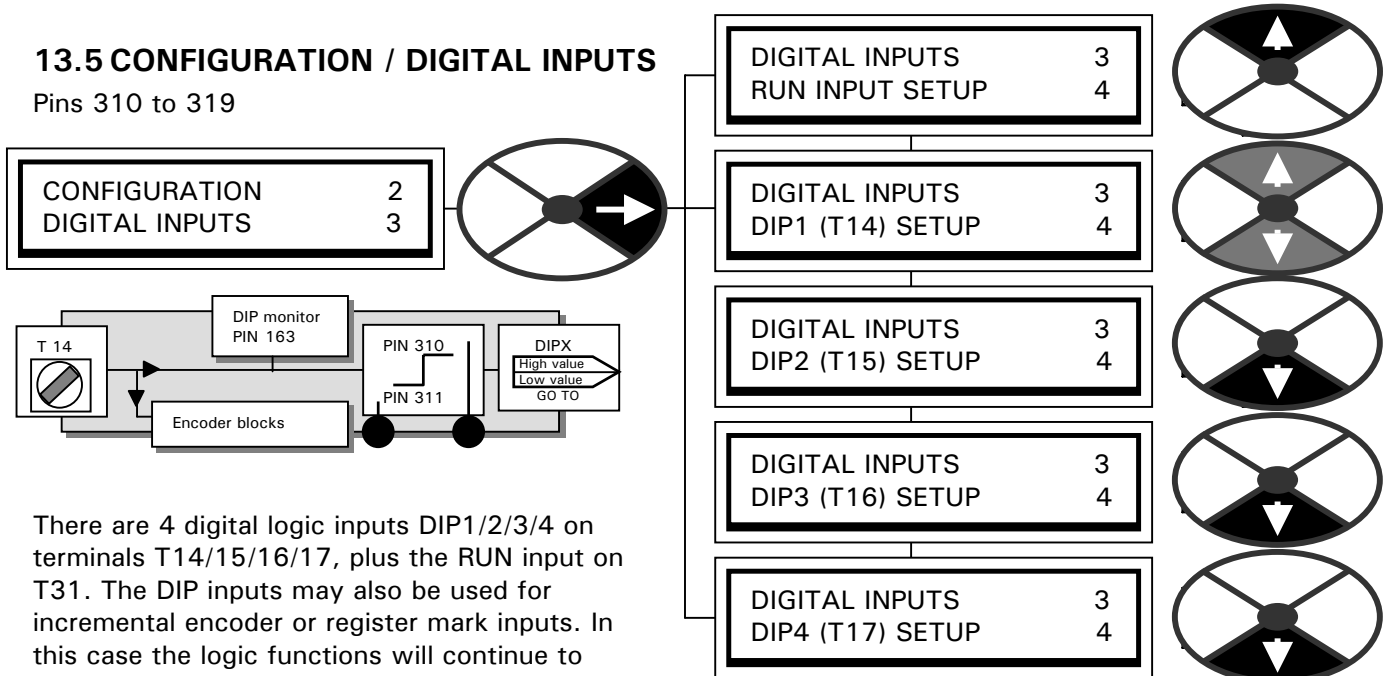

There are 4 digital logic inputs DIP1/2/3/4 on terminals T14/15/16/17, plus the RUN input on T31. The DIP inputs may also be used for incremental encoder or register mark inputs. In this case the logic functions will continue to operate as described here.

The LO and HI values can be entered using the display and keys, or may be connected to other output PINs using JUMPERS. This turns the function into a change-over switch for dynamic values. For logic only usage a value of 0.00% is read as a low. Any non zero +/- value is read as a high. Logic inversion is accomplished by entering 0.00% in the value for HI window and 0.01% in the value for LO window.

13.5.1 Using DIP inputs for encoder signals.

Logic thresholds. 0 < 2V, 1 > 4V

Note. When using encoders with quadrature outputs it is very important that the phase relationship of the 2 pulse trains remains as close to 90 degrees as possible. If the encoder is not mounted and centered accurately on the shaft, it can cause skewing of the internal optics as the shaft rotates through 360 degrees. This produces a severe degradation of the phase relationship on a cyclical basis. If the encoder appears to gyrate as the shaft rotates you must rectify the problem before trying to proceed with commissioning. The best way of checking the output is to use a high quality oscilloscope and observe both pulse trains for good phase holding and no interference. Do this with the drive rotating to +/- 100% speed using AVF as the feedback source. **Note. If a logic input with high noise immunity is required it is recommended to use a UIP.** See 6.1.10 CALIBRATION / ENCODER SCALING for more information about encoder feedback.

13.5.2 DIGITAL INPUTS / DIPX SETUP

DIGITAL INPUTS 3  
DIP1 (T14) SETUP 4

Pins used  
310 to 317.

DIP1 is shown in this menu list.

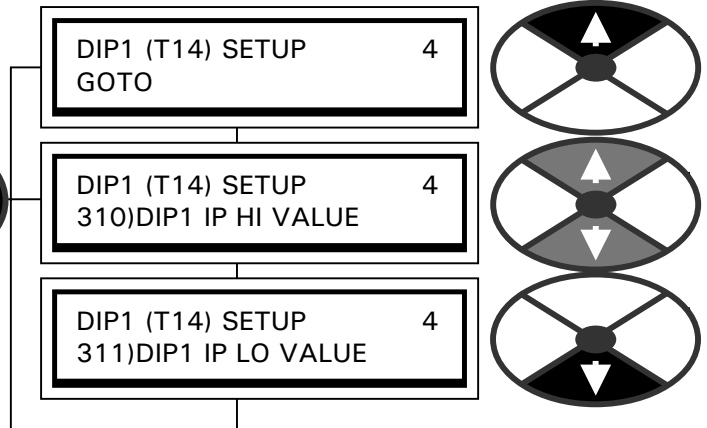

13.5.2.1 DIPX SETUP / DIP1/2/3/4 Input high value PINs 310 / 312 / 314 / 316

DIP1 (T14) SETUP 4  
310)DIP1 IP HI VALUE

310)DIP1 IP HI VALUE  
0.01%

Sets the level of the value selected by a high DIP1 input.

PARAMETER	RANGE	DEFAULT	PIN
DIP1 IP HI VAL	+/- 300.00%	0.01%	310

Note. You can make a simple AND gate by selecting this as the target PIN of a logical GOTO.

13.5.2.2 DIPX SETUP / DIP1/2/3/4 Input low value PINs 311 / 313 / 315 / 317

DIP1 (T14) SETUP 4  
311)DIP1 IP LO VALUE

311)DIP1 IP LO VALUE  
0.00%

Sets the level of the value selected by a low DIPX input.

PARAMETER	RANGE	DEFAULT	PIN
DIP1 IP LO VALUE	+/- 300.00%	0.00%	311

Note. You can make a simple OR gate by selecting this as the target PIN of a logical GOTO.

13.5.2.3 DIPX SETUP / DIP1/2/3/4 Make input value GOTO destination connection

DIP1 (T14) SETUP 4  
GOTO

GOTO  
PIN) Description of function

Defines the target source PIN for the connection to DIPX .

PARAMETER	RANGE	DEFAULT
GOTO	PIN 000 to 720	See 13.5.2.4

13.5.2.4 Default connections for DIP1/2/3/4

DIPX	Terminal Function	Terminal	High value	Low value	GO TO
DIP1	Spare input	T14	0.01% (High)	0.00% (Low)	Unconnected
DIP2	Marker input	T15	0.01% (High)	0.00% (Low)	Unconnected
DIP3	Encoder input (B train)	T16	0.01% (High)	0.00% (Low)	Unconnected
DIP4	Encoder input (A train)	T17	0.01% (High)	0.00% (Low)	Unconnected

13.5.3 DIGITAL INPUTS / RUN INPUT SETUP

Pins 318 and 319

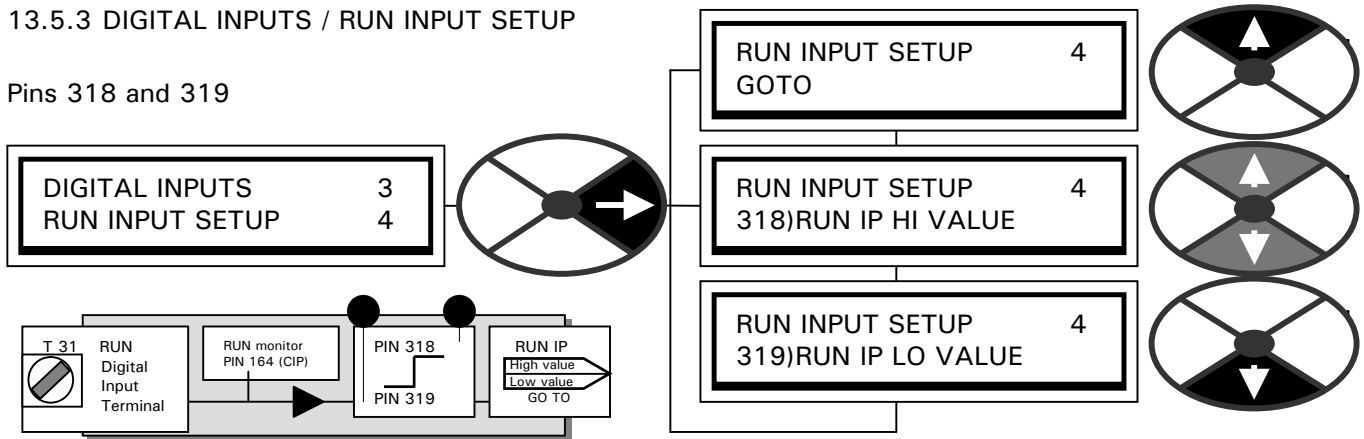

In the unlikely event that there is a shortage of digital inputs, the RUN input may be used.

The default GOTO PIN normally used by the RUN input is called 308)INTERNAL RUN IP, and must be set to a logic high when the RUN input terminal is disconnected.

See 13.9.4 SOFTWARE TERMINALS / Internal run input PIN 308.

13.5.3.1 RUN INPUT SETUP / RUN input HI value PIN 318

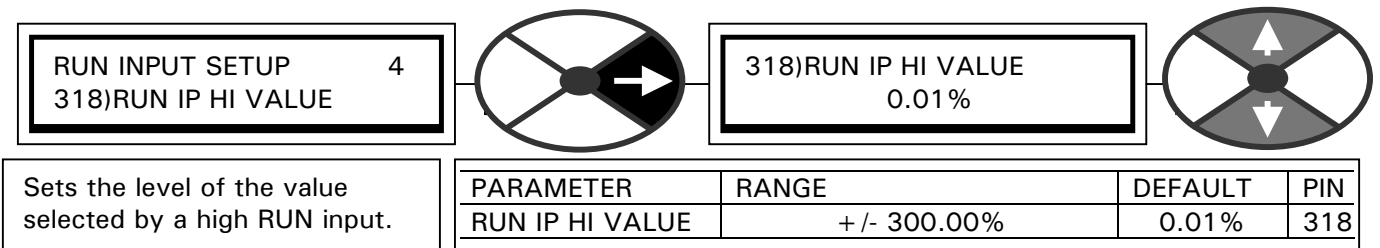

Sets the level of the value selected by a high RUN input.

Note. You can make a simple AND gate by selecting this as the target PIN of a logical GOTO.

13.5.3.2 RUN INPUT SETUP / RUN input LO value PIN 319

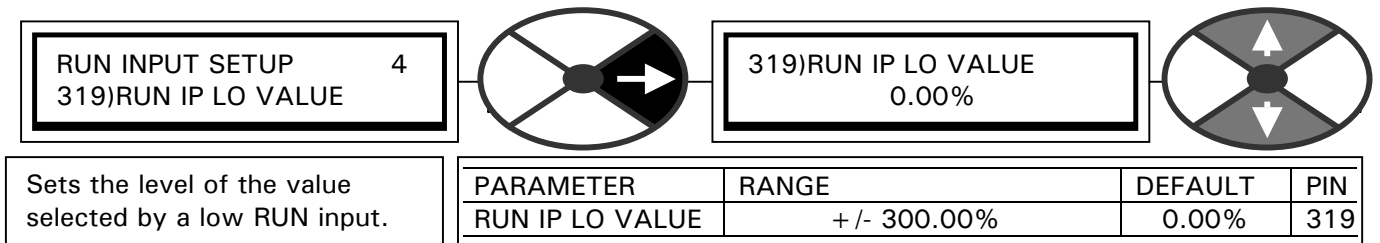

Sets the level of the value selected by a low RUN input.

Note. You can make a simple OR gate by selecting this as the target PIN of a logical GOTO.

13.5.3.3 RUN INPUT SETUP / Make input value GOTO destination connection

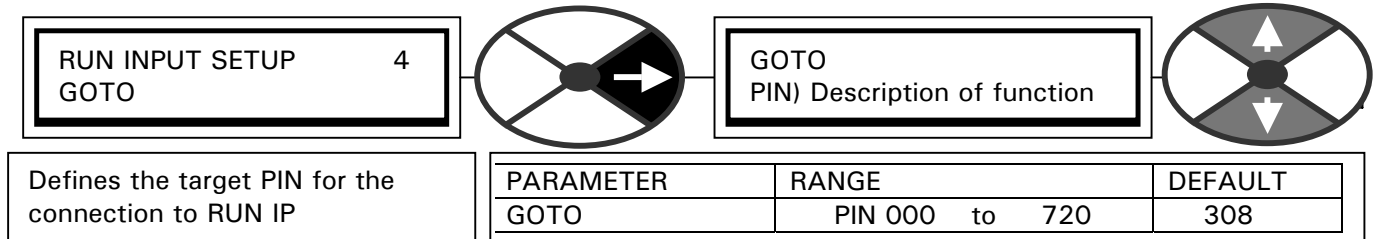

Defines the target PIN for the connection to RUN IP

### 13.6 CONFIGURATION / DIGITAL IN/OUTPUTS

CONFIGURATION	2
DIGITAL IN/OUTPUTS	3

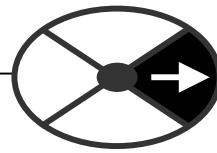

There are 4 digital input / output terminals DIO1 to DIO4.

The digital output function is connected to the terminal via a diode which is shown in the block. When the output is low then the diode is reverse biased and the terminal may be taken high if desired. Note. The PL/X must be stopped in order to implement a DIOX OP MODE change.

DIGITAL IN/OUTPUTS	3
DIO4 (T21) SETUP	4
DIGITAL IN/OUTPUTS	3
DIO1 (T18) SETUP	4
DIGITAL IN/OUTPUTS	3
DIO2 (T19) SETUP	4
DIGITAL IN/OUTPUTS	3
DIO3 (T20) SETUP	4

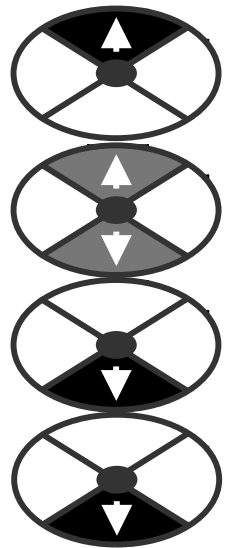

#### 13.6.1 DIGITAL IN/OUTPUTS / DIOX SETUP

PINs used 271 to 294.

DIGITAL IN/OUTPUTS	3
DIO1 (T18) SETUP	4

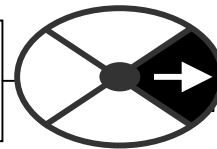

By selecting DISABLED in 271)DIO OP MODE window, the output switch is permanently open, and the terminal behaves as a digital input only. The digital output processing function may still be used internally even though the output switch is open.

By selecting ENABLED in 271)DIO OP MODE window, the output switch is permanently closed, and the terminal behaves as a digital output. The input function still operates and may be used to monitor the terminal state at any time. See 3.4.2 Digital inputs and outputs, and 7.5.2 DIGITAL IO MONITOR / DIP1 to 4 and DIO1 to 4 digital input monitor PIN 163

For systems involving multiple units with digital outputs wired in OR'd mode, the input function can be used to monitor when the last OR'd output turns off.

DIO1 (T18) SETUP	4
276)DIO1 IP LO VALUE	
DIO1 (T18) SETUP	4
271)DIO1 OP MODE	
DIO1 (T18) SETUP	4
272)DIO1 RECTIFY EN	
DIO1 (T18) SETUP	4
273)DIO1 THRESHOLD	
DIO1 (T18) SETUP	4
274)DIO1 INVERT MODE	
DIO1 (T18) SETUP	4
GET FROM	
DIO1 (T18) SETUP	4
GOTO	
DIO1 (T18) SETUP	4
275)DIO1 IP HI VALUE	

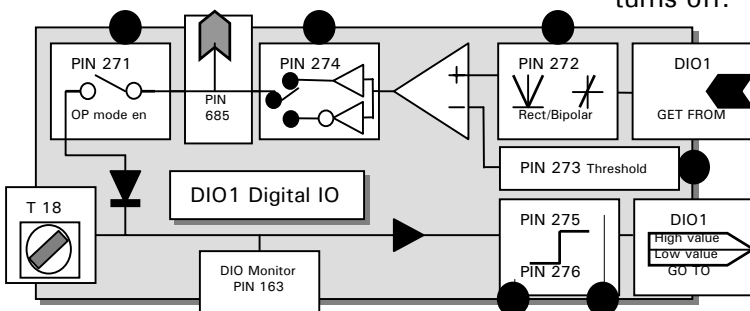
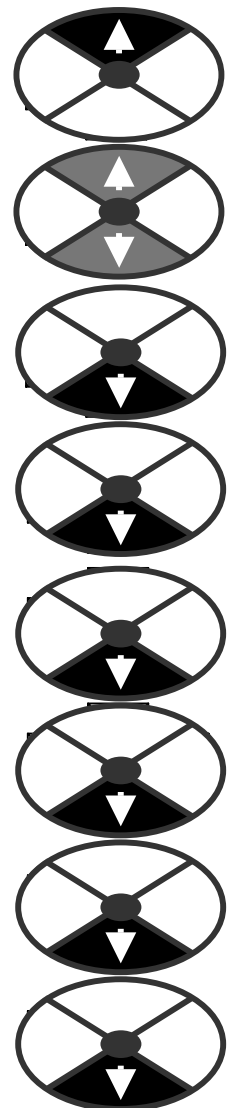

13.6.1.1 DIOX SETUP / DIO1/2/3/4 Output mode enable PINs 271 / 277 / 283 / 289

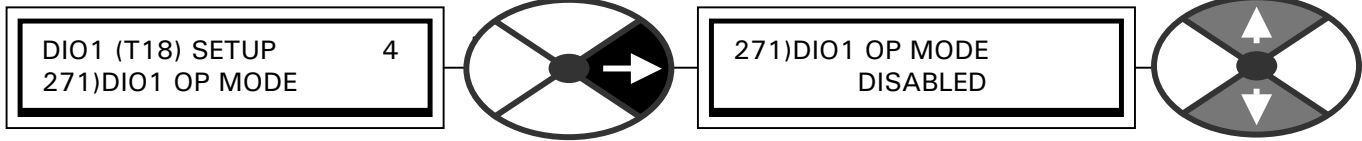

Enables the output mode of operation of the DIOX terminal.

PARAMETER	RANGE	DEFAULT	PIN
DIO1 OP MODE	ENABLED or DISABLED	DISABLED	271

Note. The terminal logic level is sensed by the input function irrespective of the output mode selection.

13.6.1.2 DIOX SETUP / DIO1/2/3/4 OP val rectify enable PINs 272/ 278 / 284 /290

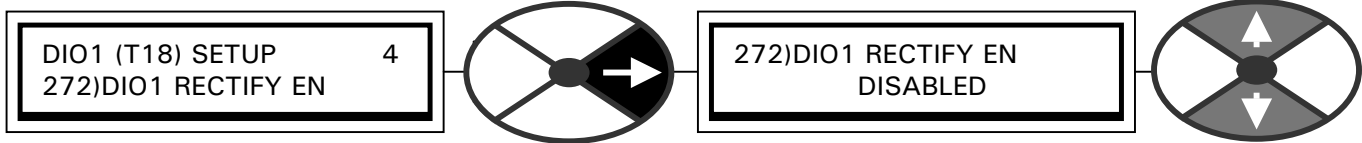

Selects rectified or bipolar mode for the OP generator.

PARAMETER	RANGE	DEFAULT	PIN
DIO1 RECTIFY EN	ENABLED or DISABLED	DISABLED	272

The digital output is generated by comparing an internal linear or logic signal with a threshold.

E.g. Linear speed feedback.

The rectified mode will enable the digital output to change state at a chosen speed for both directions of rotation.

The bipolar mode will enable the digital output to change state at only one chosen point in the entire range of positive or negative rotation.

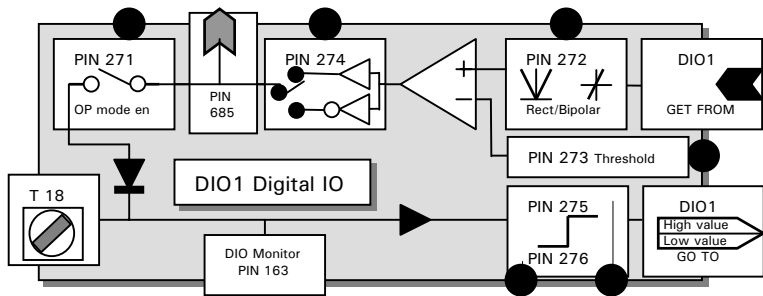

13.6.1.3 DIOX SETUP / DIO1/2/3/4 OP comp threshold PINs 273 / 279 / 285 / 290

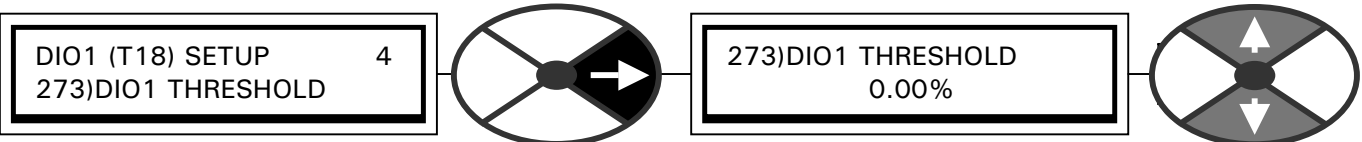

Sets the comparator threshold for the DIOX OP generator.

PARAMETER	RANGE	DEFAULT	PIN
DIO1 THRESHOLD	+/- 300.00%	0.00%	273

The output of the comparator will be high when the signal from the rectifier mode box exceeds the threshold. The comparator output is low for identical inputs. For comparing logic values always put 0.00% in the threshold window.

13.6.1.4 DIOX SETUP / DIO1/2/3/4 OP inversion PINs 274 / 280 / 286 / 291

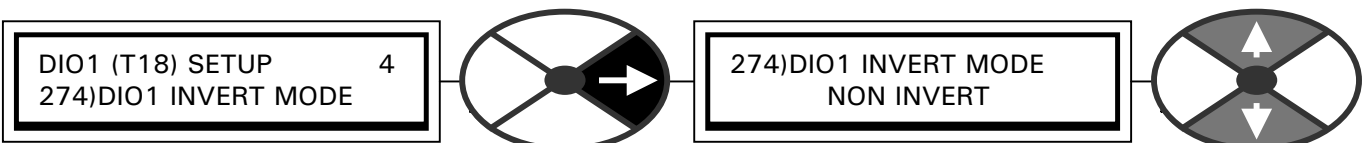

Allows the comparator output logic to be inverted for DIOX.

PARAMETER	RANGE	DEFAULT	PIN
DIO1 INVERT MODE	INVERT, NON INVERT	NON INVERT	274



13.6.1.5 DIOX SETUP / DIO1/2/3/4 Make output GET FROM source connection

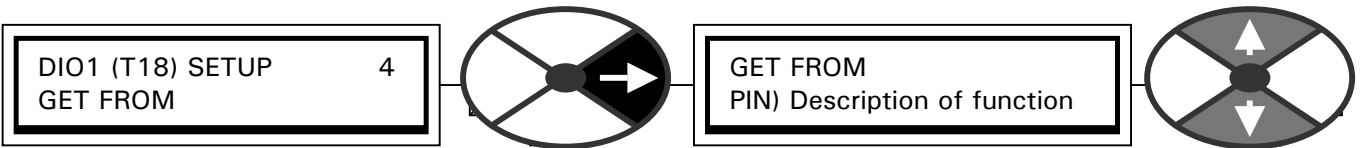

Defines the target source PIN for connection to the DIOX.

PARAMETER	RANGE	DEFAULT
GET FROM	PIN 000 to 720	400

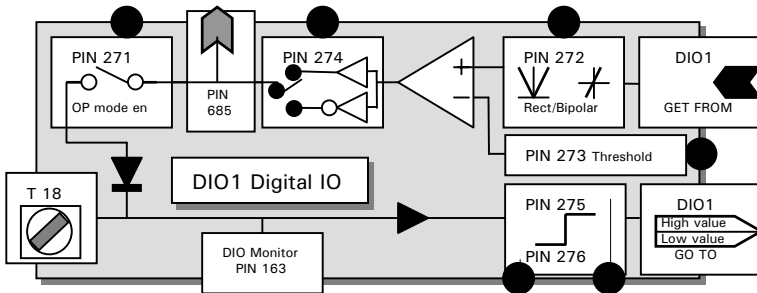

The connection is made here for the digital output block source. It may be a linear or logic value. After processing by the rectifier box it gets compared to the threshold. The comparator output state HIGH or LOW is then inverted or not inverted by the inverter mode box. It then proceeds to the output stage through the digital output enable switch and becomes a 24V logic signal. It is also available

for internal connection. See 3.4.2 Digital inputs and outputs.

13.6.1.6 DIOX SETUP / DIO1/2/3/4 Make input GOTO destination connection

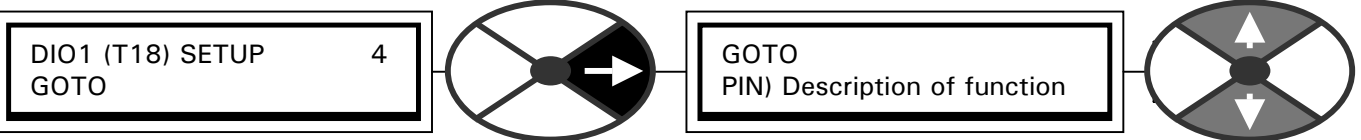

Defines the target destination PIN for connection to the DIOX.

PARAMETER	RANGE	DEFAULT
GOTO	PIN 000 to 720	See 13.6.1.9

The digital input mode detects whether the input is high or low, and then selects an output value

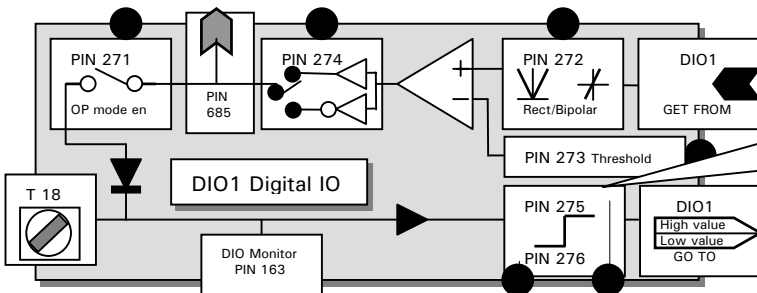

If the input is high then the HI value is selected.  
If the input is low then the LO value is selected.

The connection is made here for the digital input LO or HI result GOTO destination. The LO and HI values can be entered using the display and keys. To switch dynamically

changing values, connect them using jumpers to the LO/HI value PINS. For logic only usage a value of 0.00% is read as a low. Any non zero +/- value is read as a high. Logic inversion is accomplished by entering 0.00% in the value for HI window and 0.01% in the value for LO window.

13.6.1.7 DIOX SETUP / DIO1/2/3/4 Input high value PINs 275 / 281 / 287 / 293

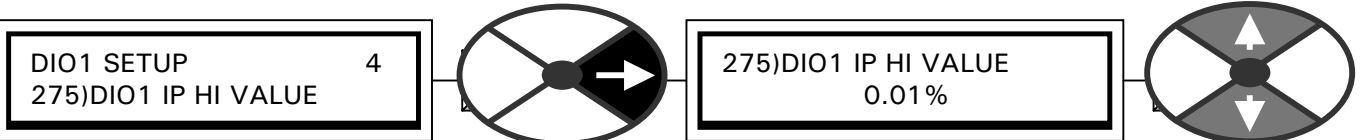

Sets the level of the value selected by a high DIOX input.

PARAMETER	RANGE	DEFAULT	PIN
DIO1 IP HI VALUE	+/- 300.00%	0.01%	275

See 13.6.1.6 DIOX SETUP / DIO1/2/3/4 Make input GOTO destination connection.

Note. You can make a simple AND gate by selecting this as the target PIN of a logical GOTO.

13.6.1.8 DIOX SETUP / DIO1/2/3/4 Input low value PINs 276 / 282 / 288 / 294

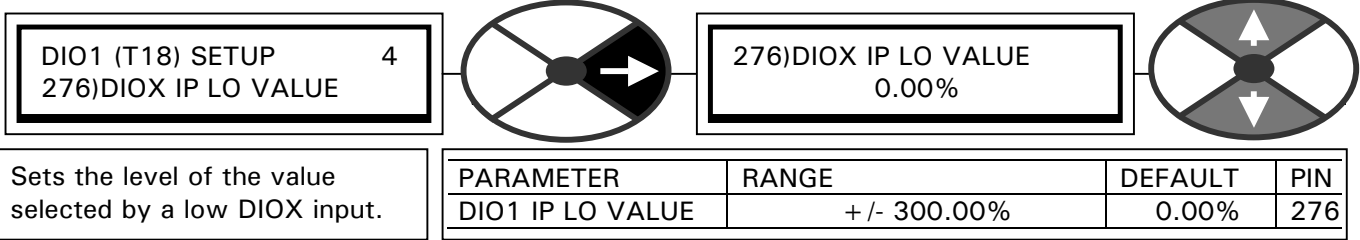

Sets the level of the value selected by a low DIOX input.

See 13.6.1.6 DIOX SETUP / DIO1/2/3/4 Make input GOTO destination connection.  
 Note. You can make a simple OR gate by selecting this as the target PIN of a logical GOTO.

13.6.1.9 Default connections for DIO1/2/3/4

DIOX	Terminal Function	Terminal	IO mode	High value	Low value	GOTO
DIO1	Zero reference interlock	T18	Input	0.01% (High)	0.00% (Low)	PIN 116
DIO2	Jog Mode select	T19	Input	0.01% (High)	0.00% (Low)	PIN 42
DIO3	Ramp Hold	T20	Input	0.01% (High)	0.00% (Low)	PIN 33
DIO4	Dual current clamp enable	T21	Input	0.01% (High)	0.00% (Low)	PIN 88

13.6.1.10 DIO1/2/3/4 Internal output result PINs 685/6/7/8

There is a hidden PIN for each block to enable internal connection of the output processing part of the block. This section of the block will continue to function irrespective of the output mode.  
 DIO1/2/3/4 PIN 685/6/7/8)DIO1 O/P BIN VAL.

13.7 CONFIGURATION / DIGITAL OUTPUTS

PINs used 261 to 269.

There are 3 digital outputs DOP1/2/3.

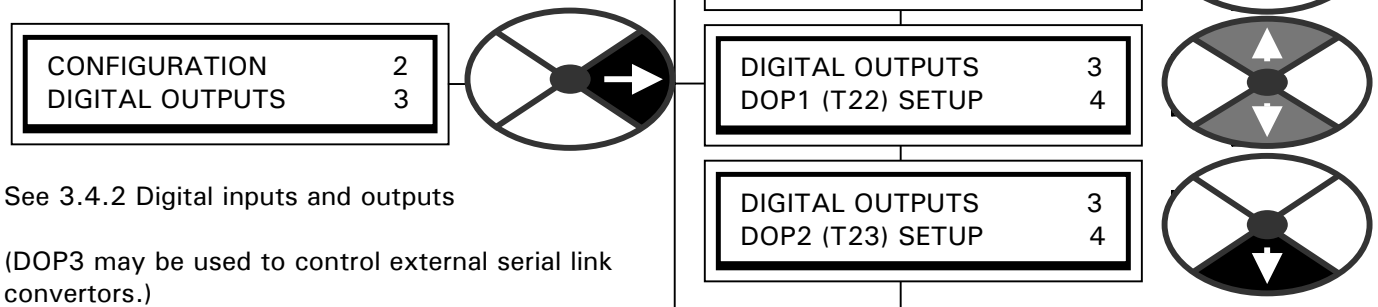

See 3.4.2 Digital inputs and outputs

(DOP3 may be used to control external serial link convertors.)

13.7.1 DIGITAL OUTPUTS / DOPX SETUP

The windows are shown for DOP1. DOP2/3 windows are identical apart from the PIN numbers.

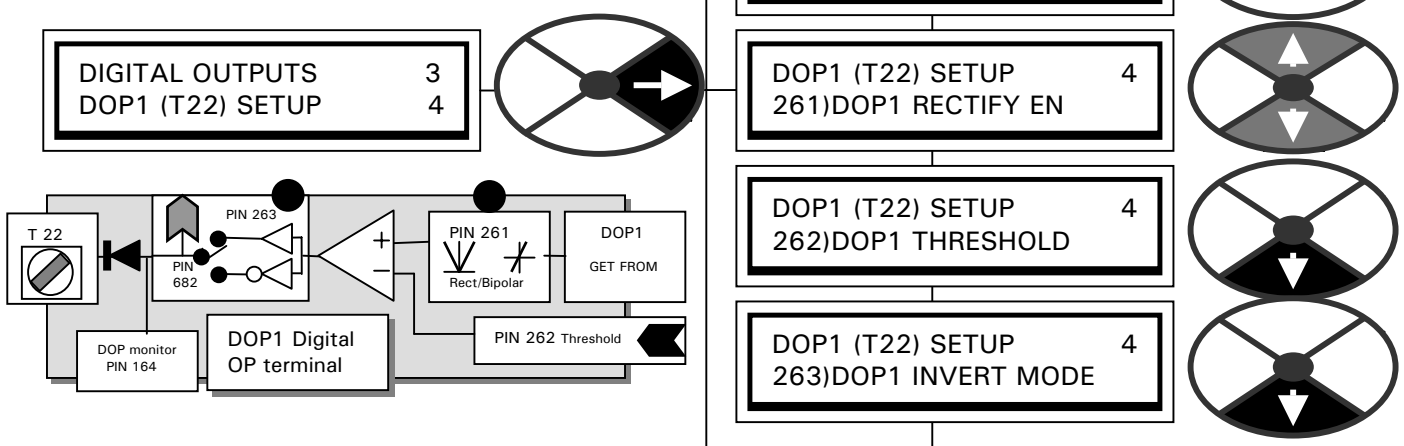

13.7.1.1 DOPX SETUP / DOP1/2/3 OP val rectify enable PINs 261 / 264 / 267

DOP1 (T22) SETUP 4  
261)DOP1 RECTIFY EN

261)DOP1 RECTIFY EN  
ENABLED

Enables rectified mode for the OP generator.

PARAMETER	RANGE	DEFAULT	PIN
DOP1 RECTIFY EN	ENABLED or DISABLED	ENABLED	261

The digital output is generated by comparing an internal linear or logic signal with a threshold. Select DISABLED for the bi-polar mode.

E.g. Linear speed feedback. The rectified mode will enable the digital output to change state at a chosen speed for both directions of rotation. The bipolar mode will enable the digital output to change state at only one chosen point in the entire range of positive or negative rotation.

13.7.1.2 DOPX SETUP / DOP1/2/3 OP comparator threshold PINs 262 / 265 / 268

DOP1 (T22) SETUP 4  
262)DOP1 THRESHOLD

262)DOP1 THRESHOLD  
0.00%

Sets the comparator threshold for the DOPX OP generator.

PARAMETER	RANGE	DEFAULT	PIN
DOP1 THRESHOLD	+/- 300.00%	0.00%	262

The output of the comparator will be high when the signal from the rectifier mode box exceeds the threshold. The comparator output is low for identical inputs.

13.7.1.3 DOPX SETUP / DOP1/2/3 Output inversion enable PINs 263 / 266 / 269

DOP1 (T22) SETUP 4  
263)DOP1 INVERT MODE

263)DOP1 INVERT MODE  
NON-INVERT

Allows the comparator output logic to be inverted for DOPX

PARAMETER	RANGE	DEFAULT	PIN
DOP1 INVERT MODE	INVERT or NON-INVERT	NON-INVERT	263

13.7.1.4 DOPX SETUP / DOP1/2/3 Make output GET FROM source connection

DOP1 (T22) SETUP 4  
GET FROM

GET FROM  
PIN) Description of function

Defines the source PIN for the connection to DOPX OP

PARAMETER	RANGE	DEFAULT
GET FROM	PIN 000 to 720	400

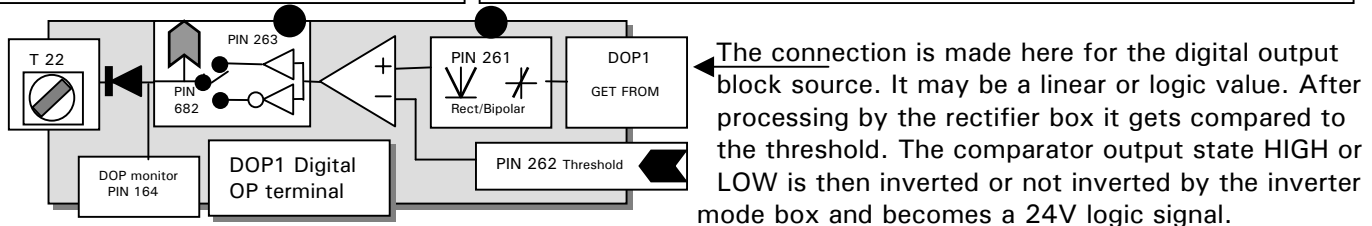

The connection is made here for the digital output block source. It may be a linear or logic value. After processing by the rectifier box it gets compared to the threshold. The comparator output state HIGH or LOW is then inverted or not inverted by the inverter mode box and becomes a 24V logic signal.

For comparing logic values always put 0.00% in the threshold window. The comparator output is low for identical inputs.

13.7.1.5 Default connections for DOP1/2/3

DOPX	Terminal Function	Terminal	Threshold	Getfrom source	GET FROM Pin
DOP1	Zero speed	T22	0.00% (Low)	Zero speed flag	PIN 120
DOP2	Ramping flag	T23	0.00% (Low)	Ramping flag	PIN 35
DOP3	Drive healthy	T24	0.00% (Low)	Drive healthy flag	PIN 698

13.7.1.6 DOP1/2/3 Internal output result PINs 682/3/4

The binary result of these outputs is available for internal use on PINs 682 DOP1, 683 DOP2, 684 DOP3.

13.8 CONFIGURATION / STAGING POSTS

PIN number range 296 to 303.

These staging posts are like virtual wire wrap posts.

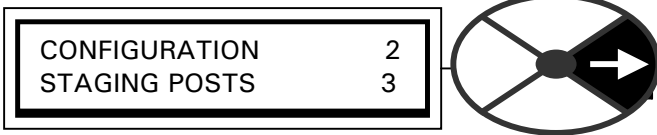

There are 4 digital posts and 4 analogue posts.

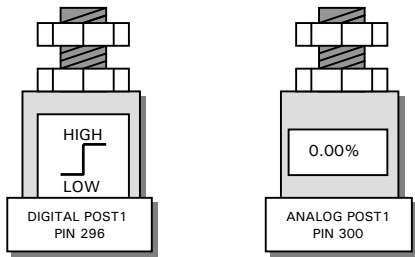

The digital and analogue posts are allocated PIN numbers and are used as virtual wiring nodes. They can contain a value or act as constants for setting a value.

1) When receiving values via a serial link, the posts can store the data and are then connected by the user to the desired destinations.

2) Blocks in the applications menu are normally dormant. Connecting the output to a PIN destination other than 400 activates them. Using a software post is extremely useful during system commissioning if a block output needs to be examined prior to incorporation into a system.

The block output will be activated by connecting it to one of these posts. It may then be monitored via the display, and if required, connection to an analogue output terminal using the terminals GET FROM link allows monitoring with an oscilloscope. See also 13.4.3 ANALOG OUTPUTS / Scope output select PIN 260. When satisfied with the output functionality, you can then connect it to the final system destination. The analogue posts are used for linear values. The digital posts are used for logic values, a zero value is a logic low, a non zero +/- value is a logic high.

Note. Staging posts are also used for making connections between a GOTO and a GETFROM.

Note. Any unused settable PIN may perform the function of a staging post. A convenient cluster of 8 PINs can be found in the PRESET SPEED application block for example.

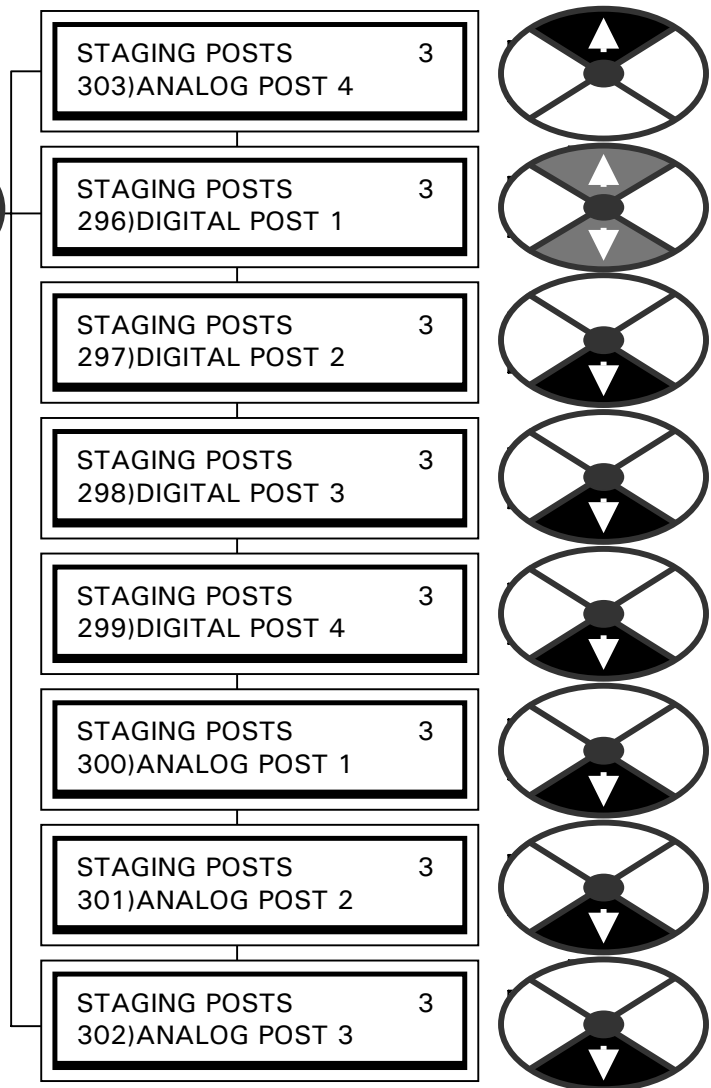

13.8.1 Connecting PINs with different units

When using the available methods of connection it is perfectly feasible, indeed likely, that an output PIN scaled in one set of units will be linked to another PIN normally scaled in a different set of units. E.g. The output of analogue input terminal scaled in % may be connected to the ramp parameter called FORWARD UP TIME, which is scaled in seconds. This is no problem for the system because when it is processing the blocks it works in an internal system of pure numbers. This allows PINs of any type of units and scaling range to be inter-connected. To do this it follows a simple set of rules.

The internal pure number range is a 5 digit number equal to +/-30,000 counts.  
All linear parameters work with numbers that lie within this range.

13.8.1.1 Connecting linear values with different units

The pure number for any parameter can be found by stripping out the decimal point and the units.

0.1 = 1  
5.00% = 500  
200.00 = 20,000

E.g. 60)DROP OUT DELAY range 0.1 to 600.0 seconds. In this case the pure number range is 1 to 6000.  
59)DROP OUT SPEED range 0.00 to 100.00%. In this case the pure number range is 0 to 10,000.

When a connection is made the pure number is transferred from the output to the input during processing. If the pure number that arrives at a PIN lies outside the range of that PIN then it will automatically be clamped to the maximum limit of the target PIN.

E.g. 129)TACHO VOLTS MON = 190.00 VOLTS pure number = 19,000 is connected to 24)REVERSE UP TIME. This has a range of 0.1 to 600.0 SECONDS. When the pure number of 19,000 arrives it will be clamped to 6,000 and displayed as 600.0 SECONDS.

13.8.1.2 Connecting logic values with different messages

In the system there are several parameters that have only 2 states, and some that have more than 2.

E.g. 64)SPD/CUR REF 3 SIGN = INVERT State 0 2 states  
or NON-INVERT State 1  
29)RAMP AUTO PRESET = DISABLED State 0 2 states  
or ENABLED State 1  
9)SPEED FBK TYPE = ARMATURE VOLTAGE State 0 5 states  
TACHOGENERATOR State 1  
ENCODER State 2  
ENCODER + AVF State 3  
ENCODER + TACHO State 4

When using 2 state logic parameters the system sees one state as 1 and the other as a 0 according to this table.

LOGIC 1 PARAMETER	LOGIC 0 PARAMETER
HIGH	LOW
ENABLED	DISABLED
MOTOR 2	MOTOR 1
INVERT	NON-INVERT
Non zero or negative value in logic statement	Zero value in logic statement

If the value is connected from a PIN which uses a binary or hexadecimal string (e.g.digital IO monitor) then the pure decimal equivalent is used. When calculating the decimal equivalent, the most significant bit is on the **right** and the least significant on the **left**.

13.8.1.3 Connecting to multi-state logic parameters

When connecting to multi state logic parameters (E.g. SPEED FBK TYPE or UIPX RANGE), the states are placed in numerical order as follows.

- 1<sup>st</sup> choice = logic 0
- 2<sup>nd</sup> choice = logic 1
- 3<sup>rd</sup> choice = value of pure number 2
- 4<sup>th</sup> choice = value of pure number 3
- 5<sup>th</sup> choice = value of pure number 4

Hence in order to switch between choice 1 (value 0) and 2 (value 1) a normal logic flag may be connected as the source of control. If the block providing the instruction to change state, possesses a value for high/low output, (e. g. digital input DIP1) ensure that a low is 0.00% value, and a high 0.01% value.

To switch between type 4(value 3) and type 5(value 4), use a value for low of 0.03%, and for high, 0.04%.

If the source of logic state is internal and does not possess a value for high/low, then utilise one of the C/O SWITCHES. See the Applications Manual for details of the C/O SWITCH.

E. g. The C/O SWITCH uses a logic value to switch between a HI value input and a LO value input.

To switch between type 4(value 3) and type 5(value 4), use a LO value of 0.03%, and HI value, 0.04%.

Hence when the logic value is 0, the C/O SWITCH will send the value of pure number 3 to the multi state PIN, and then choice 4 will be selected. Likewise choice 5 will be selected for a logic 1.

13.8.2 STAGING POSTS / Digital / analog 1/2/3/4 PINs 296 to 303

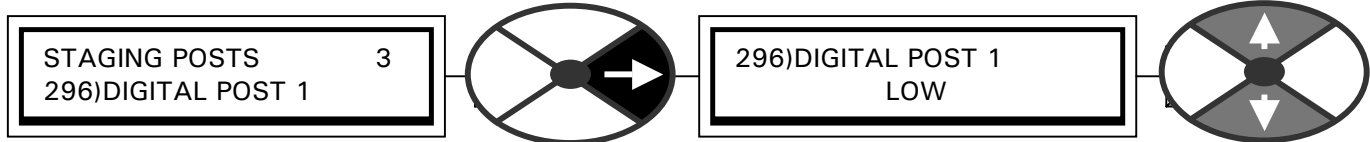

Used as storage point for logic state and/or connecting point.

PARAMETER	RANGE	DEFAULT	PIN
DIGITAL POST 1	HIGH or LOW	LOW	296

When a pure logic value of 0 arrives at a DIGITAL SOFTWARE POST the display will show LOW. When a pure logic value of 1 arrives it will show HIGH.

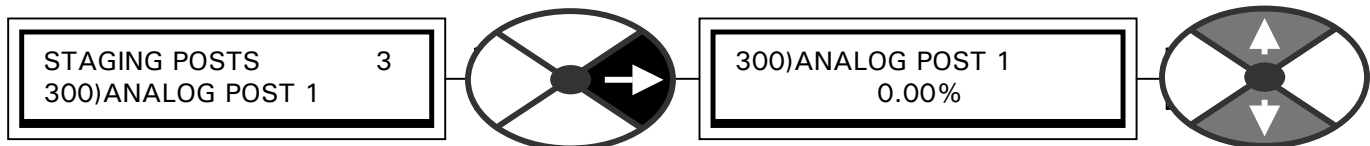

Used as storage point for linear values and/or connecting point.

PARAMETER	RANGE	DEFAULT	PIN
ANALOG POST 1	+/-300.00%	0.00%	300

### 13.9 CONFIGURATION / SOFTWARE TERMINALS

PIN numbers used 305 to 308.

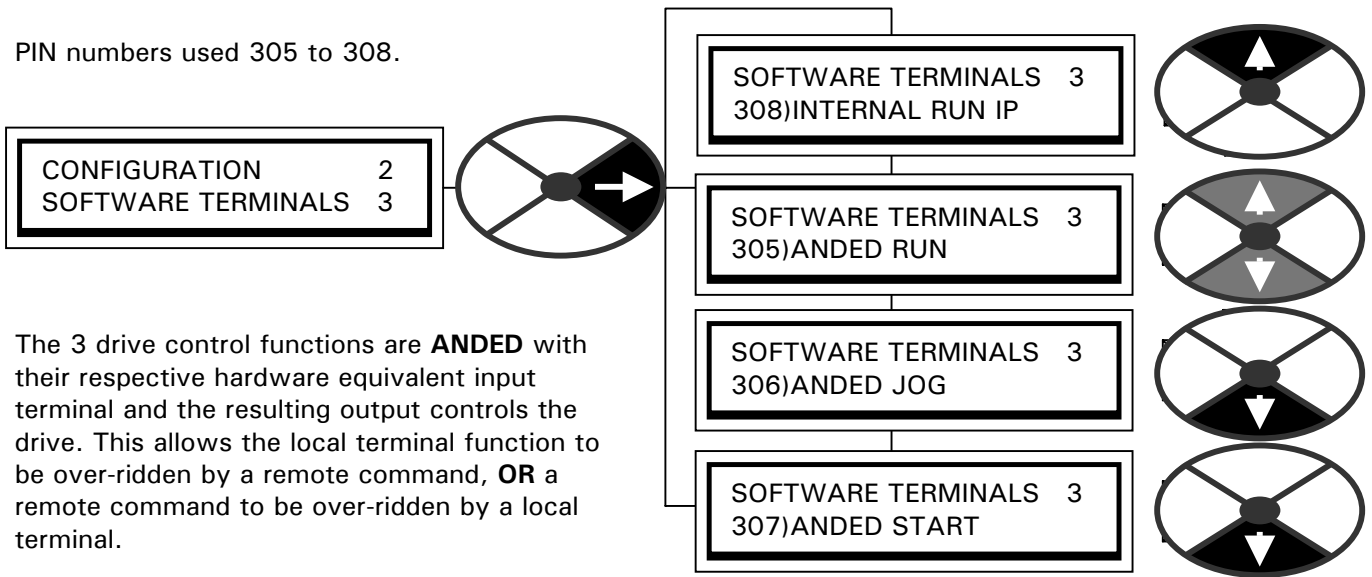

The 3 drive control functions are **ANDED** with their respective hardware equivalent input terminal and the resulting output controls the drive. This allows the local terminal function to be over-riden by a remote command, **OR** a remote command to be over-riden by a local terminal.

#### 13.9.1 SOFTWARE TERMINALS / Anded run PIN 305

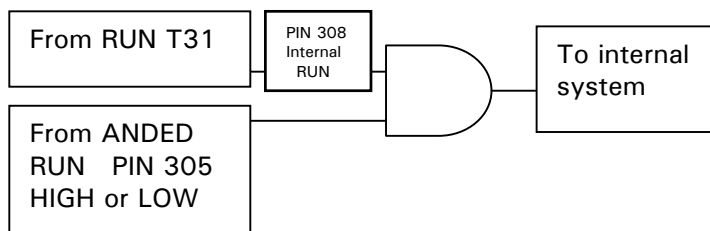

305)ANDED RUN is normally used by a serial link to control the drive. The local hardware terminal in the LOW position will defeat the serial link. The serial link in the OFF position will defeat the local hardware terminal.

**Note.** If the RUN terminal has been used as a general digital input, then 308)INTERNAL RUN IP must be set HIGH for the drive to run.

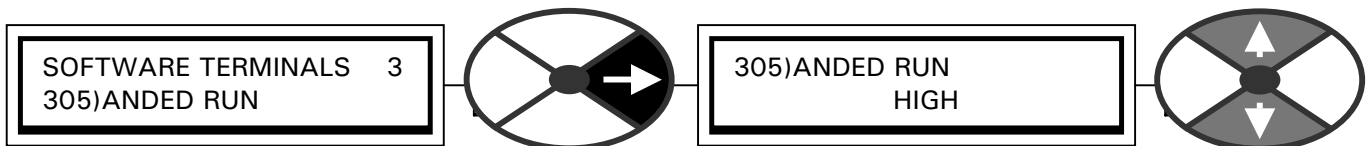

Sets a logic input to an internal AND gate to control RUN.

PARAMETER	RANGE	DEFAULT	PIN
ANDED RUN	HIGH or LOW	HIGH	305

#### 13.9.2 SOFTWARE TERMINALS / Anded jog PIN 306

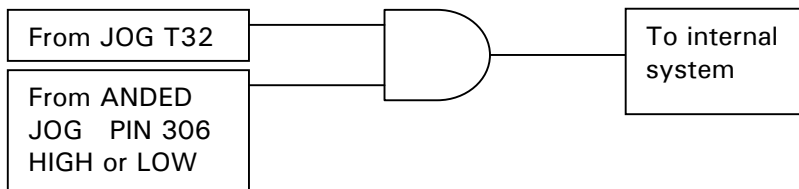

306)ANDED JOG is normally used by a serial link to control the drive. The local hardware terminal in the LOW position will defeat the serial link.

The serial link in the OFF position will defeat the local hardware terminal.

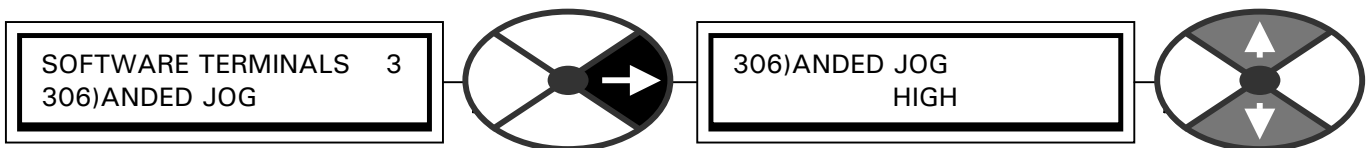

Sets a logic input to an internal AND gate to control JOG

PARAMETER	RANGE	DEFAULT	PIN
ANDED JOG	HIGH or LOW	HIGH	306

13.9.3 SOFTWARE TERMINALS / Anded start PIN 307

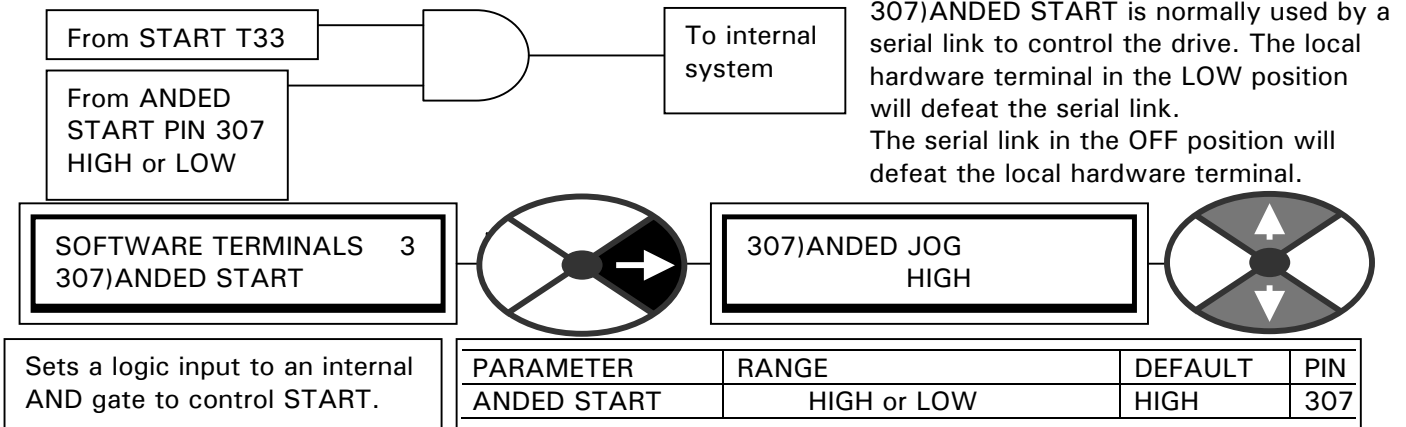

13.9.4 SOFTWARE TERMINALS / Internal run input PIN 308

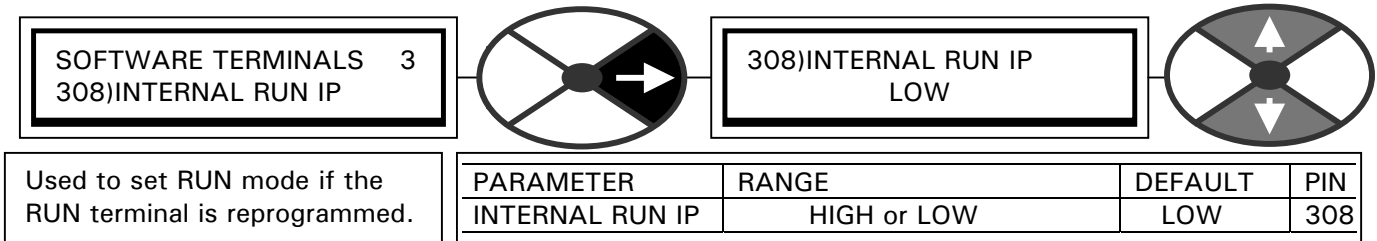

The RUN command normally comes from the default RUN terminal (T31) and will show the state of T31. However this terminal may be used as a programmable terminal in the event of a shortage of digital inputs. In this case 308)INTERNAL RUN IP must be disconnected from the RUN terminal and set HIGH to allow the drive to run.



### 13.10 CONFIGURATION / JUMPER CONNECTIONS

This menu defines the JUMPER connection PINs using GET FROM and GOTO windows

There are 16 uncommitted JUMPERS

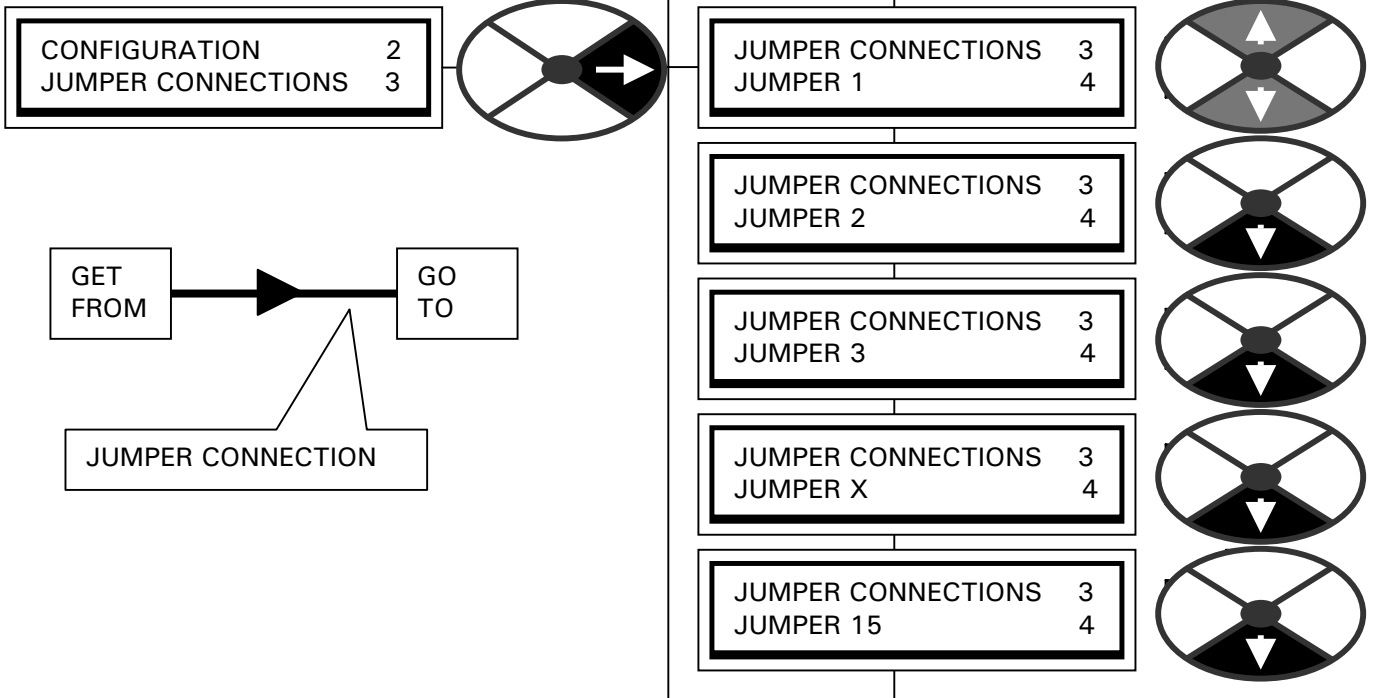

#### 13.10.1 JUMPER CONNECTIONS / Make jumper GET FROM source connection

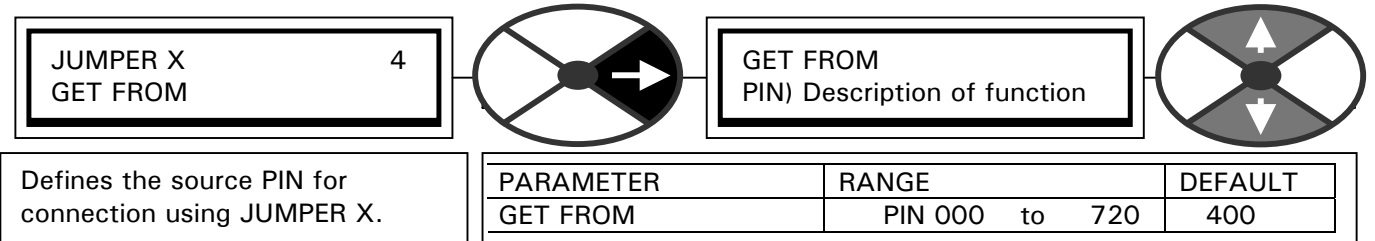

#### 13.10.2 JUMPER CONNECTIONS / Make jumper GOTO destination connection

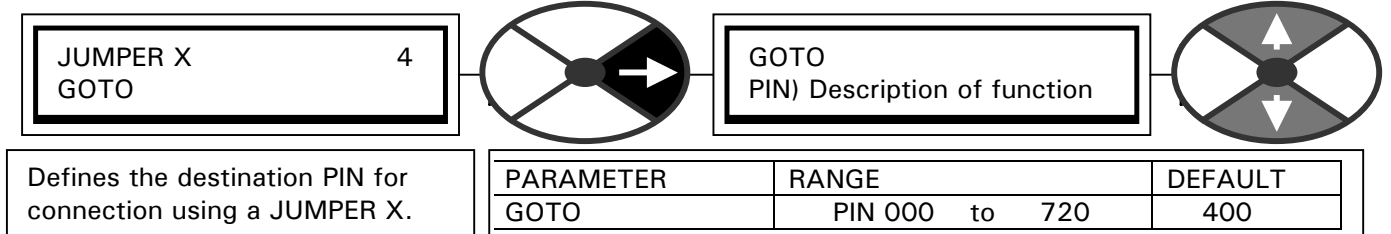

See 13.2.4 JUMPER connections for a description of the type of connections possible.

### 13.11 CONFIGURATION / BLOCK OP CONFIG

This menu is used to connect block diagrams.

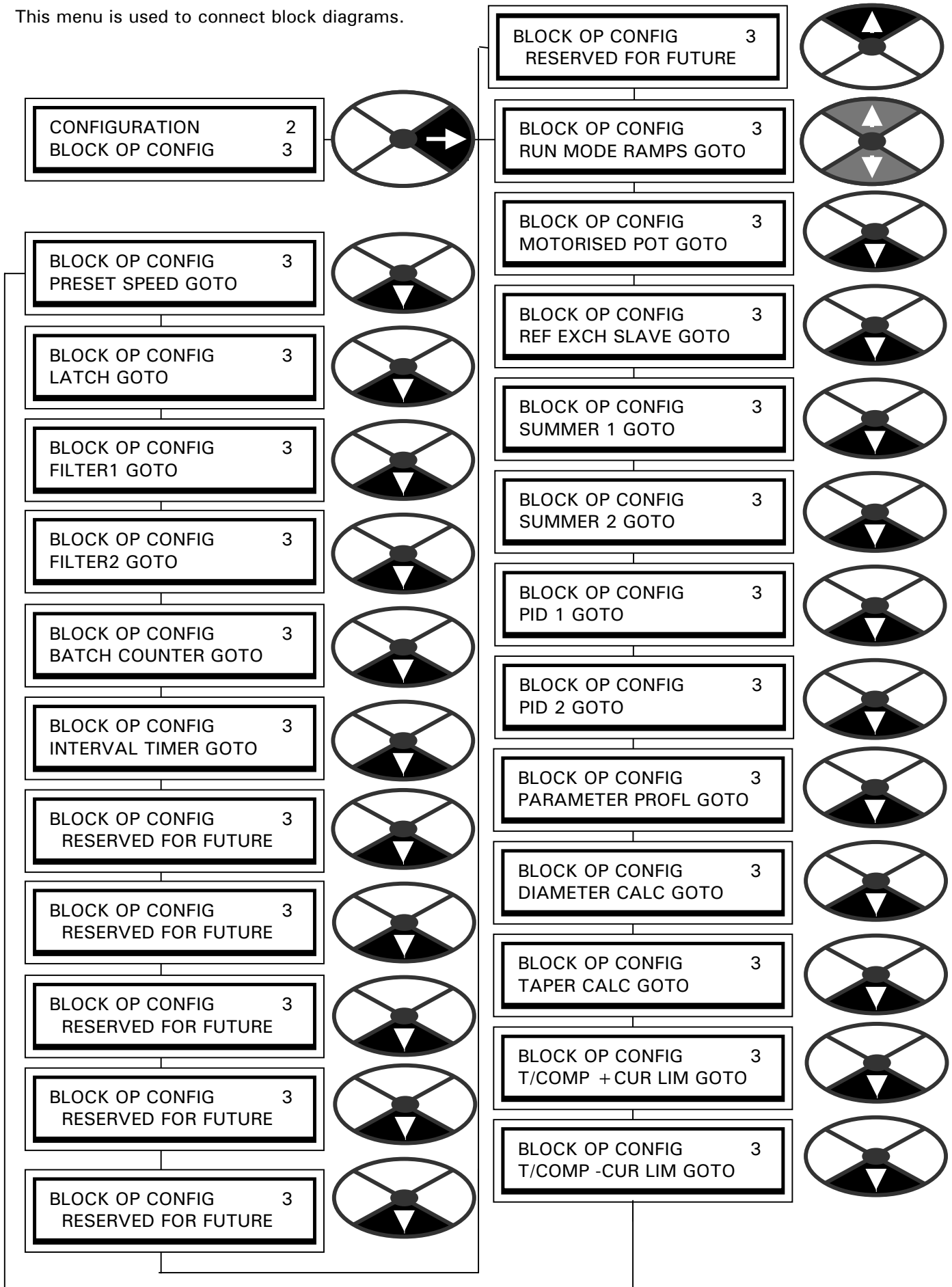

13.11.1 BLOCK OP CONFIG / Block outputs GOTO

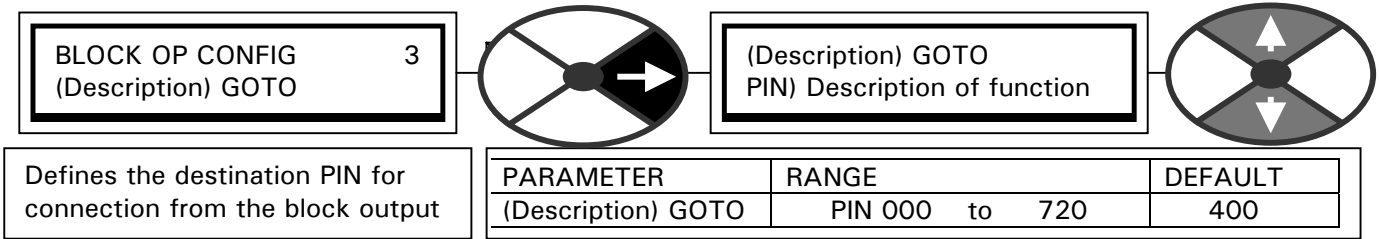

13.11.2 Other GOTO windows

Not all of the GOTO connection windows are found in this menu. Some blocks have them contained within their own menus. These include the following :-

Input/output terminals. Multi - function blocks 1 - 8 Jumpers Comparators C/O switches

These functions occur in multiples and have few other parameters to program. Therefore as an aid in assisting the user to remember the particular unit in use at the time of connection, each one contains its own GOTO window.

The application blocks have many parameters to adjust and it is convenient to define their individual connections within this BLOCK DIAGRAM menu.

Connecting the GOTO to a PIN other than 400)Block disconnect, causes activation of the block.

All GET FROM windows are found within their block menus.

13.12 CONFIGURATION / FIELDBUS CONFIG

This section outlines the FIELDBUS CONFIG menu. It is used to select parameters for transmitting to, or receiving from, the host controller using for example PROFIBUS protocol.

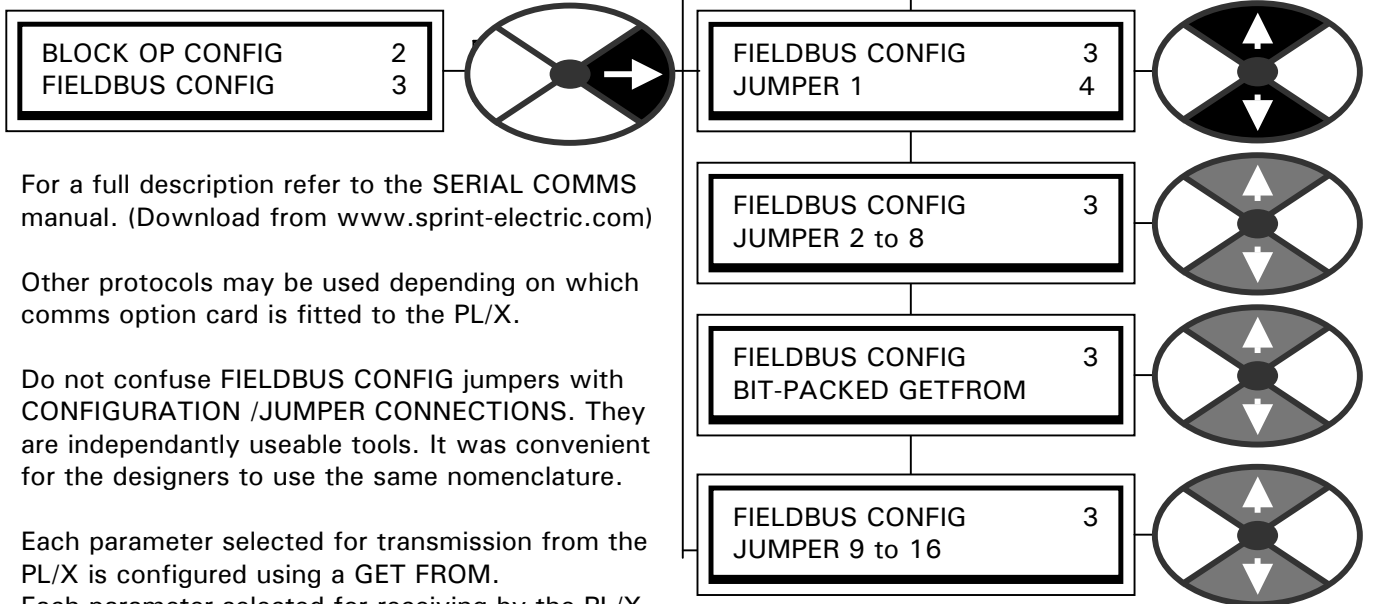

For a full description refer to the SERIAL COMMS manual. (Download from [www.sprint-electric.com](http://www.sprint-electric.com))

Other protocols may be used depending on which comms option card is fitted to the PL/X.

Do not confuse FIELDBUS CONFIG jumpers with CONFIGURATION /JUMPER CONNECTIONS. They are independantly useable tools. It was convenient for the designers to use the same nomenclature.

Each parameter selected for transmission from the PL/X is configured using a GET FROM. Each parameter selected for receiving by the PL/X is configured using a GOTO.

There is also "DATA ON DEMAND" providing a roaming read/write facility to any PIN.

There are many advantages to providing FIELDBUS configuration on the PL/X itself, rather than relying on the host system to control the configuration.

- 1) Any PL/X parameter is available for selection as a source by each one of 8 GET FROMs (1 word each), + one group of 8 way bit packed logic value GET FROMs (1 word).
- Any legal PL/X parameter is available for selection as a target by each one of 8 GOTOs (1 word each), + one group of 8 way bit packed logic value GOTOs (1 word).
- 2) The PL/X GOTO conflict checker automatically checks to see if the GOTO connections are accidentally configured by the user to another PL/X GOTO.
- 3) Reconfiguring the FIELDBUS for any PL/X, without stopping the master or other PL/X units, is possible.
- 4) The FIELDBUS configuration for each PL/X is held within the unit itself and is also retained in the parameter exchange file. 3 FIELDBUS configurations can be saved in each PL/X by using the 3 recipe pages.

### 13.13 CONFIGURATION / DRIVE PERSONALITY

PIN numbers used 677 to 680  
 This menu is used to modify or monitor various aspects of the PL/X personality.

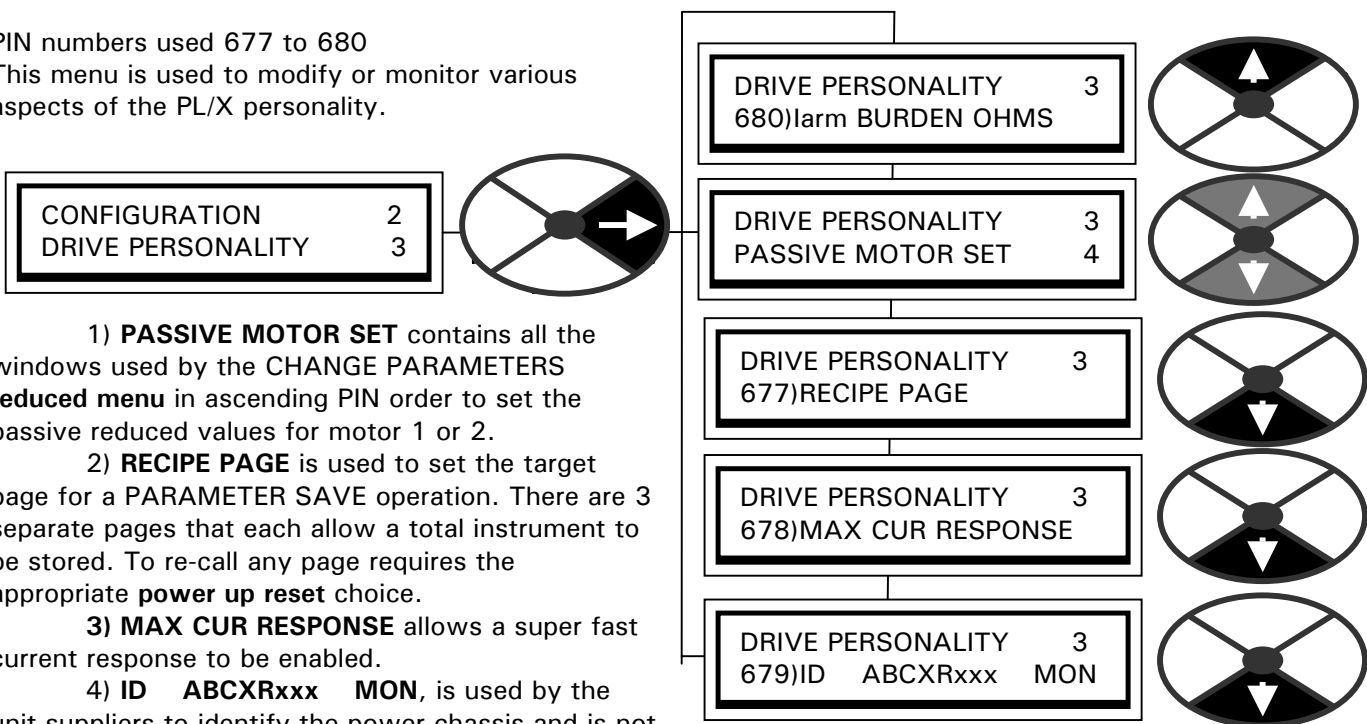

- 1) **PASSIVE MOTOR SET** contains all the windows used by the CHANGE PARAMETERS reduced menu in ascending PIN order to set the passive reduced values for motor 1 or 2.
- 2) **RECIPE PAGE** is used to set the target page for a PARAMETER SAVE operation. There are 3 separate pages that each allow a total instrument to be stored. To re-call any page requires the appropriate **power up reset** choice.
- 3) **MAX CUR RESPONSE** allows a super fast current response to be enabled.
- 4) **ID ABCXRxxx MON**, is used by the unit suppliers to identify the power chassis and is not intended to be used for any other purpose. A binary code is displayed.
- 5) **Iarm BURDEN OHMS** is used, along with the actual burden, to derate the model armature current.

#### 13.13.1 DRIVE PERSONALITY / PASSIVE MOTOR SET

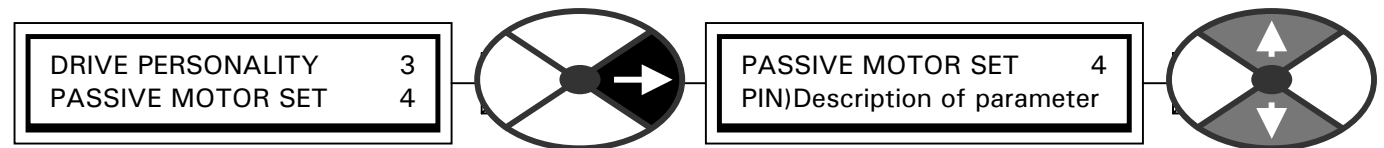

Allows viewing and alteration of the passive reduced menu.	PARAMETER	RANGE	PIN
	PASSIVE MOTOR SET	Reduced menu parameters	XXX

See 6.1.17 CALIBRATION / Motor 1 or 2 select PIN 20.  
 This menu is also useful for a rapid review of the alterable parameters in the CHANGE PARAMETERS reduced menu, or setting these parameters for a second system while the existing system is running a motor.  
 See 11.1 DISPLAY FUNCTIONS / Reduced menu enable.  
 The power up default function (See 5.1.3 Restoring the drive parameters to the default condition) is applied to both sets of values. However each set preserves its prevailing CALIBRATION parameters. See chapter 15. PIN number tables to identify the members of the CHANGE PARAMETERS reduced menu.

13.13.2 DRIVE PERSONALITY / Recipe page PIN 677

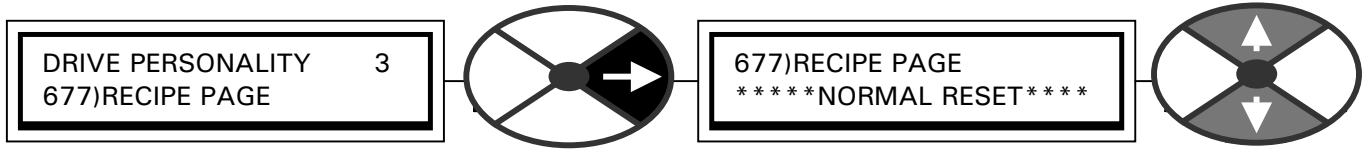

Sets the recipe page for the PARAMETER SAVE function.	PARAMETER	RANGE	DEFAULT	PIN
	RECIPE PAGE	NORMAL, 2, 3 or 4-KEY RESET	NORMAL RESET	677

If left unchanged, the window will show which instrument recipe page has been called.

To make a recipe permanently operative it must be SAVED in the NORMAL page. To re-call any page requires the appropriate power up reset choice. (Pressing keys during the application of the control supply).

Selected page / (Type of POWER UP)	SOURCE page	DESTINATION FOR SAVE OPERATIONS
NORMAL RESET / (No keys)	NORMAL page	PARAMETER SAVE overwrites NORMAL page
2-KEY RESET / (Up/Down)	Page 2	PARAMETER SAVE overwrites page 2
3-KEY RESET / (Up/Down/Right)	Page 3	PARAMETER SAVE overwrites page 3
4-KEY ROM RESET / (All 4 keys)	Factory Defaults	PARAMETER SAVE overwrites NORMAL page

Note. Any parameters that are memorised during a power off sequence will be saved on the selected page. After a 2, 3, or 4 key power up reset, the display confirms the type of reset, and asks for LEFT KEY TO RESTART. The left key must be pressed within 15 seconds otherwise the unit reverts to the NORMAL page. Note. If when SAVING, the message AUTHORISATION NEEDED appears, then this means that the page is LOCKED and is read only. Please refer to your supplier or system integrator, he may have installed a special recipe in this particular page that prevents itself from being over-written. Each page may have its own password, but be aware you might overwrite the password when saving parameters from a different recipe page. For this reason it is recommended that the same password is used in each page.

13.13.2.1 Recipe page block diagram

See also 5.3 Archiving PL/X recipes.

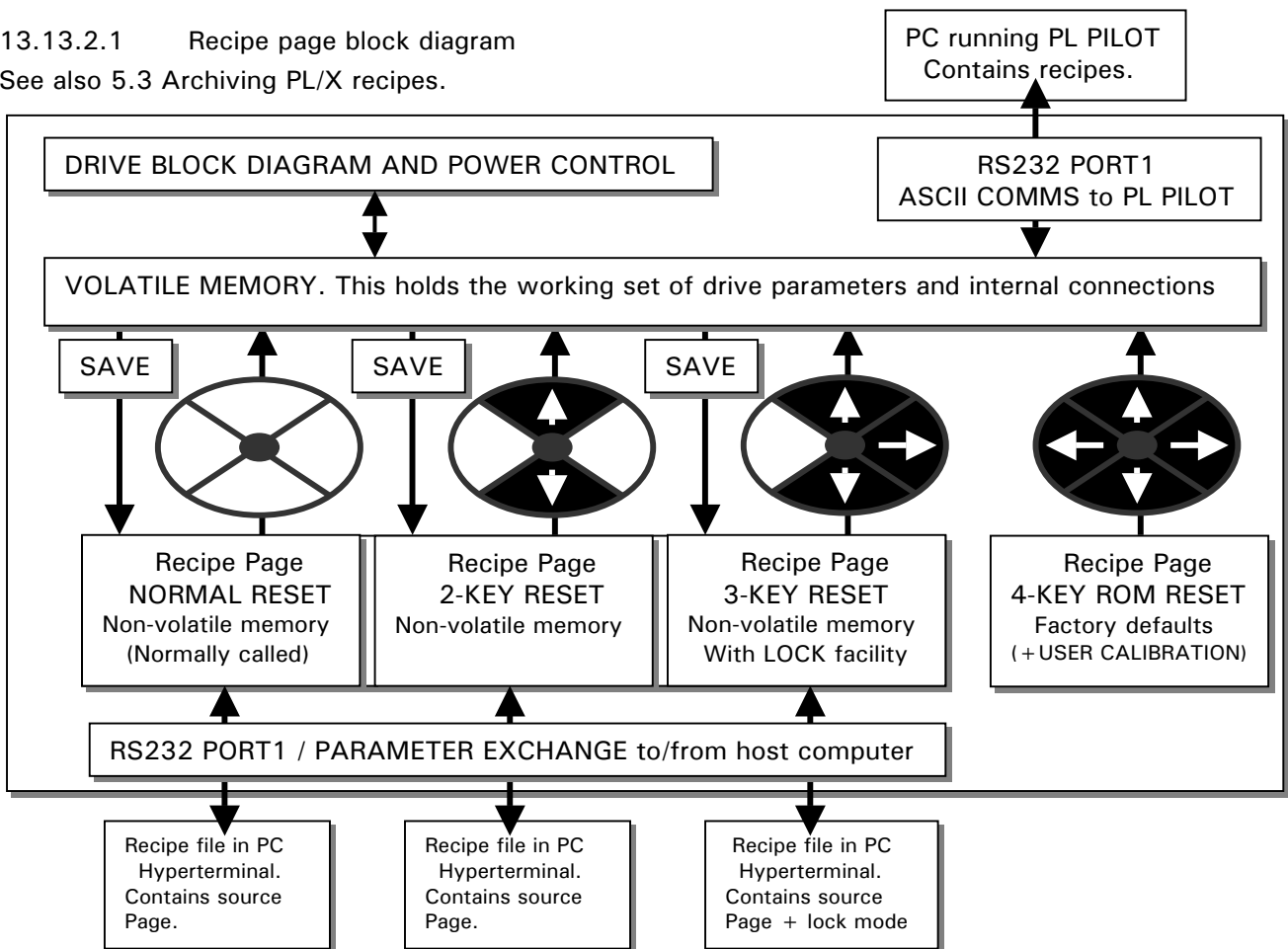

13.13.3 DRIVE PERSONALITY / Maximum current response PIN 678

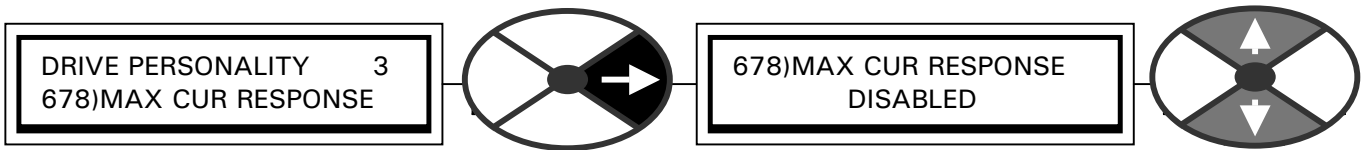

When enabled, this activates a super fast current response.	PARAMETER	RANGE	DEFAULT	PIN
	MAX CUR RESPONSE	ENABLED or DISABLED	DISABLED	678

The PL/X is capable of providing a super fast current response. When enabled, the current loop algorithm is internally adjusted to provide a very rapid response, with no dead band when switching bridges. When enabled, it is important that the speed and current control terms are carefully set for optimum performance otherwise current overshoots or noisy feedback signals may cause instability. When disabled, the current response is similar to a standard performance DC controller, which in most cases is completely acceptable, also the PL/X is more tolerant of poor feedback/control term settings.

13.13.4 DRIVE PERSONALITY / Armature current burden resistance PIN 680

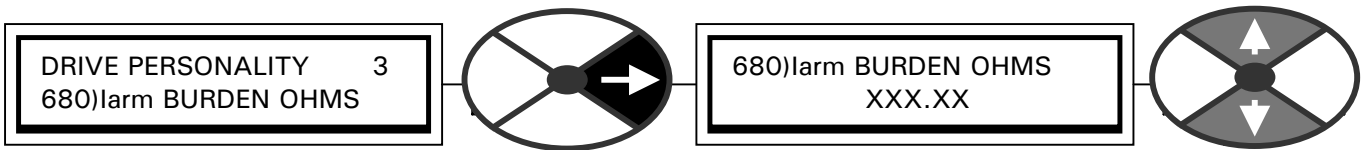

This value <b>must be</b> the same as the actual BURDEN Ohms.	PARAMETER	RANGE	DEFAULT	PIN
	Iarm BURDEN OHMS	0.00 to 320.00	According to MODEL	680

The burden resistors are on the lower edge of the power board to the right of the 8 way terminal block.

(R100//R101 100% parallel back pair) or (R102//R103 50% parallel front pair) selected by jumper.

Formula. Combined value of BURDEN OHMS = 2000/max model amps. For PL/X 5 - 145.  
 Combined value of BURDEN OHMS = 4000/max model amps. For PL/X 185 - 225.

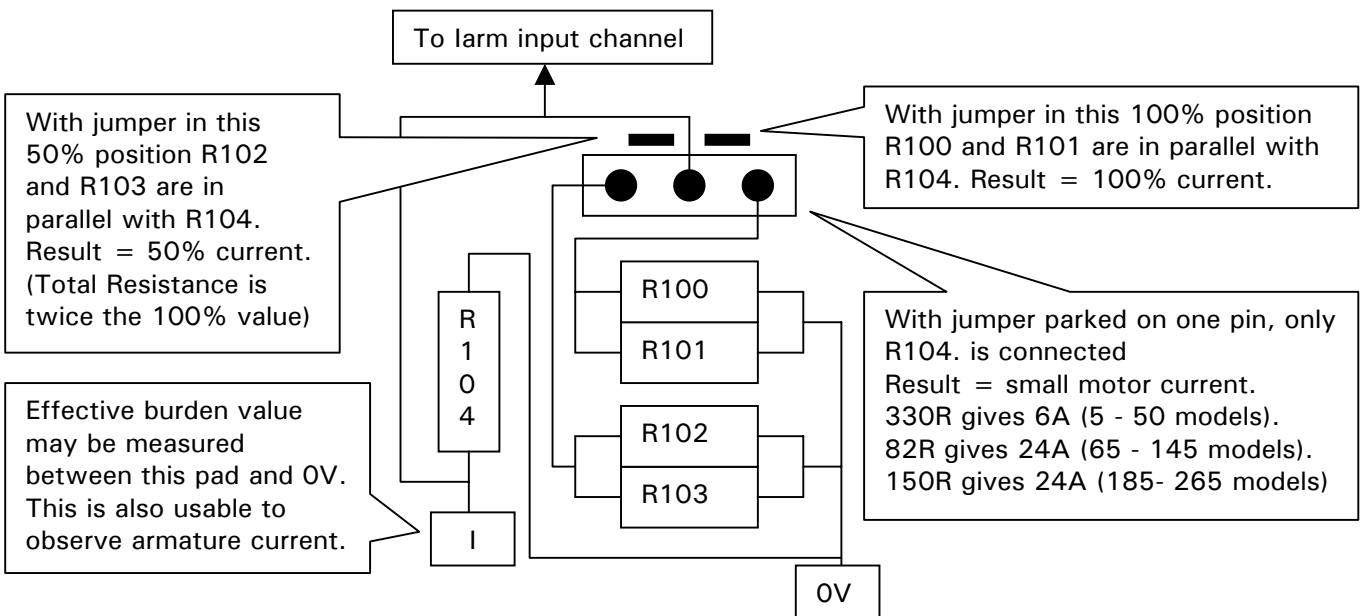

- Note. After parameter 680)Iarm BURDEN OHMS has been altered, it will only apply after the following steps:-
- 1) Save the new value using the PARAMETER SAVE function.
  - 2) Turn the unit control supply off then back on again.
  - 3) Adjust- 2)RATED ARM AMPS parameter in the CALIBRATION menu, first to its maximum setting (100%), and then to its minimum setting (33%), (Note that the values are 100% Amps, 33% Amps, of new ratings with changed burden). Finally return it to the desired value for your motor.
  - 4) Save the new desired 2)RATED ARM AMPS parameter with another PARAMETER SAVE.

13.13.4.1 50% / 100% rating select

The burden resistors AND a selection jumper are on the power board to the right of the 8 way terminal block. The left hand position of the jumper sets the actual burden resistance to twice the standard value and hence reduces the model rating to 50%.

(Higher burden values give lower model ratings).

Using this with DRIVE PERSONALITY / 680)Iarm BURDEN OHMS provides a 6 - 1 calibration range.

To measure the actual burden resistance use an ohmmeter across the **pad marked I** and the right hand end of the front resistor (R103) 0V. The **pad marked I** is a square pad adjacent to terminal 48.

**The jumper has a third operating mode. If the jumper is parked on one pin, then the actual burden resistance will be high to allow the use of small test motors.**

Model	Left hand jumper position	Right hand jumper position	Parked jumper position Amps and Actual Burden Ohms
PL/X 5 - 50	50% of max model rating	100% of max model rating	6 Amps max 330R
PL/X 65 - 145	50% of max model rating	100% of max model rating	24 Amps max 82R
PL/X 185 - 265	50% of max model rating	100% of max model rating	24 Amps max 150R

See also 4.5.4 PASSIVE MOTOR defaults / Using passive motor menu for small test motors. This is used to test small motors without changing the actual burden resistor value.

Note. When using the parked position for small test motors, you may choose to set CONFIGURATION / DRIVE PERSONALITY / 680)Iarm BURDEN OHMS to the parked value, or leave it at the prevailing model rating. If you set it to the parked value in the normal way, then the armature current calibration range of the PL/X will reflect the parked position for small motors. If you leave it set to the prevailing model rating then the PL/X parameters will assume the normal full ratings despite the actual current being limited to the parked position range for small motors. This may be useful if the configuration involves armature current related parameters that need testing at full value despite the fact that only a small current is flowing.

E.g. A PLX50 is calibrated for 110Amps. The jumper is parked, and a 6 Amp motor is used to test the unit without altering 680)Iarm BURDEN OHMS. At 100% current, 6 Amps will be flowing in the armature, but 110Amps will be displayed on 135)ARM CUR AMPS MON.

Table of burden resistor values for models with jumper selection. R104 = 6A or 24Amp depending on model, R103 // R102 // R104 = 50%, R101 // R100 // R104 = 100%.

Amps	Theoretical Burden (Rt) Also 680)Iarm BURDEN OHMS		Fixed as shown for small motors R104 ohms	R103 // R102 // R104 50% 1% 0.6W R103 // R102 ohms	R100 // R100 // R104 100% 1% 0.6W R100 // R100 ohms
	100%	or 50%			
12	166.66	319.95	6Amps / 330	10,500 // empty	680 // 680
24	83.33	167.46	6Amps / 330	680 // 680	220 // 220
36	55.55	110.44	6Amps / 330	332 // 332	66.5 // empty
51	39.21	78.21	6Amps / 330	205 // 205	88.7 // 88.7
72	27.77	55.35	6Amps / 330	66.5 // empty	60.4 // 60.4
99	20.20	40.68	6Amps / 330	46.4 // empty	43 // 43
123	16.26	32.46	6Amps / 330	36 // empty	34 // 34
155	12.90	25.68	24Amps / 82	37.4 // empty	30.1 // 30.1
205	9.75	19.48	24Amps / 82	51.1 // 51.1	22.1 // 22.1
270	7.41	14.76	24Amps / 82	36 // 36	16.2 // 16.2
330	6.06	11.96	24Amps / 82	28 // 28	13 // 13
430	9.30	18.50	24Amps / 150	42.2 // 42.2	19.6 // 19.6
530	7.54	14.95	24Amps / 150	33.2 // 33.2	15.8 // 15.8
630	6.35	12.55	24Amps / 150	27.4 // 27.4	13.3 // 13.3

See 13.13.4 DRIVE PERSONALITY / Armature current burden resistance PIN 680 for burden formula.

## 13.13.4.2 WARNING about changing BURDEN OHMS



It is important that the parameter 680)Iarm BURDEN OHMS, is set as closely as possible to the actual resistance used on the power board. **DO NOT ALLOW THE MODEL RATING TO EXCEED THE VALUES IN THE RATING TABLE AND ON THE RATING LABEL FOUND UNDER THE UPPER END CAP. FAILURE TO HEED THIS WARNING WILL INVALIDATE ANY WARRANTY, AND VIOLATE APPROVAL STANDARDS. NO LIABILITY IS ACCEPTED BY THE MANUFACTURER AND/OR DISTRIBUTOR FOR FAULTS CAUSED BY RE-RATING OF THE PRODUCT.**

## 13.13.4.3 Changing control or power cards

Whenever it is necessary to replace either the control card or the power assembly, or transfer a control card to a new power assembly then 680)Iarm BURDEN OHMS and the actual BURDEN OHMS must be re-checked and 680)Iarm BURDEN OHMS changed if necessary according to the above procedures. See 13.13.4

## Removing the control card

First remove the plastic cover from the unit. To do this remove the end caps, then remove the 4 corner fixing screws that retain the cover. When removing the cover please take care not to stress the display and key connection ribbons. Unplug the ribbons from the control card to completely remove the top cover. The plugs are keyed to ensure correct reconnection.

Then remove the two retaining screws at the lower corners of the control card. Lift the lower edge of the control card up. The card hinges on the upper pair of plastic retainers. The only resisting force is due to the 2 X 20 interconnect pins in their sockets just above terminals T17 to T30. Once the pins have fully withdrawn from their sockets, hinge the card gently away to an angle of about 30 degrees. At this point the upper hinges are open and the card can be eased out of them.

Side view.

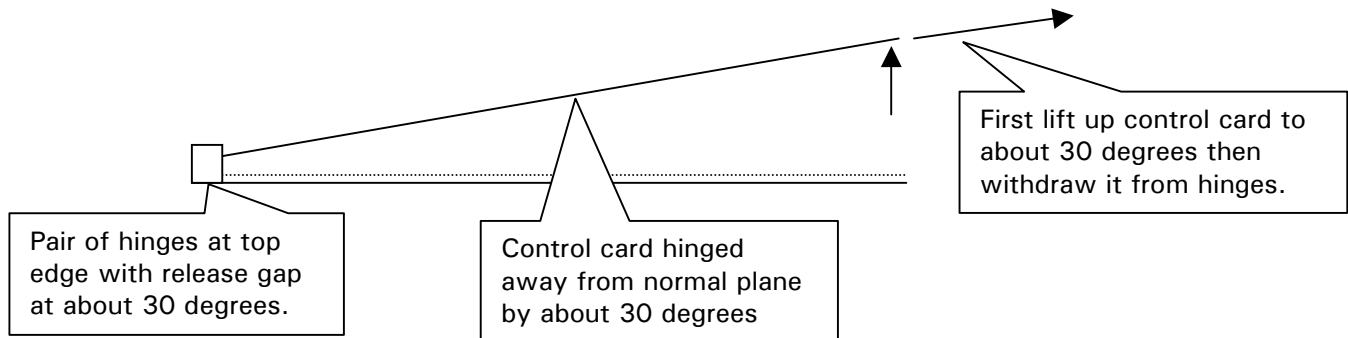

To re-assemble, perform the above procedure in reverse order. The control card is guided by the hinges back onto the interconnect pins. It is not possible to screw the control card flat unless the interconnect pins are all correctly located.

**WARNING.** During IC insertion avoid bending the control card and causing damage. This is best achieved by removing the control card and supporting it on a suitable surface. Special attention must be paid to providing support to the card in the area of the IC being inserted, to avoid stressing the surrounding components.



### 13.14 CONFLICT HELP MENU

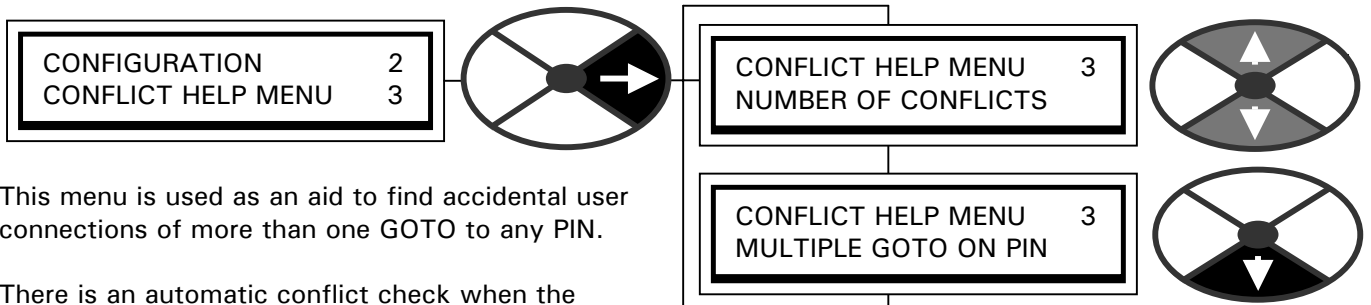

This menu is used as an aid to find accidental user connections of more than one GOTO to any PIN.

There is an automatic conflict check when the ENABLE GOTO, GETFROM is set to DISABLED.

(This is done at the end of a configuration session). If a conflict is found, the display will give the alarm message GOTO CONFLICT. See 13.2.7 CONFIGURATION / ENABLE GOTO, GETFROM.

#### 13.14.1 CONFLICT HELP MENU / Number of conflicts

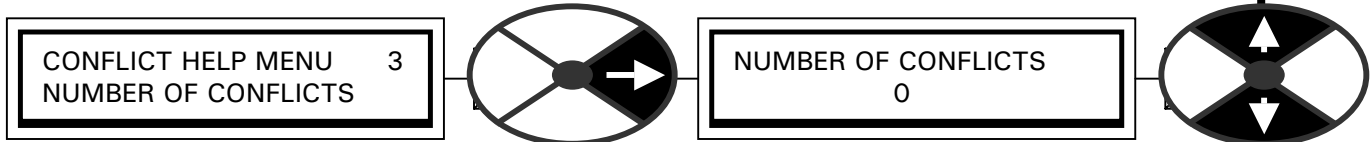

Shows the number of GOTO connections in conflict.	PARAMETER	RANGE
	NUMBER OF CONFLICTS	0 to 50

Note, there will be at least 2 conflicts for each conflict PIN. Removing one GOTO from the conflict PIN will reduce the conflict number by at least 2.

This window has a branch hopping facility to the MULTIPLE GOTO ON PIN window.

#### 13.14.2 CONFLICT HELP MENU / Multiple GOTO conflict PIN identifier

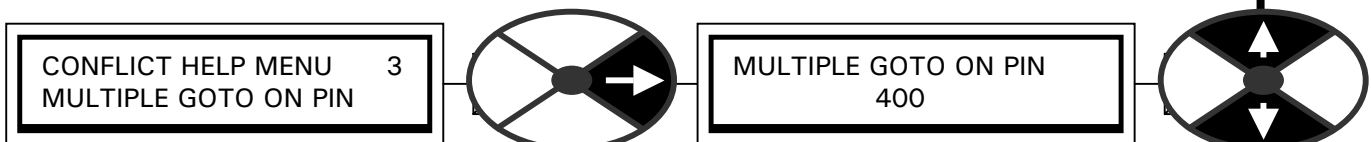

Shows the next PIN with more than 1 GOTO connected	PARAMETER	RANGE
	MULTIPLE GOTO ON PIN	0 to 720

Note, there will be at least 2 conflicts for each conflict PIN. Removing one GOTO from the conflict PIN will reduce the conflict number by 2. The number 400 is block disconnect and indicates no conflicts. This window has a branch hopping facility to the NUMBER OF CONFLICTS window.



## 14 Installation

<b>14</b>	<b>Installation.....</b>	<b>203</b>
14.1	Product rating table.....	204
14.2	Product rating labels .....	204
14.3	Semiconductor fuse ratings.....	204
14.3.1	Proprietary fuses.....	205
14.3.2	European stock fuses.....	205
14.3.3	DC semi-conductor fuses .....	206
14.4	PL/X family cover dimensions.....	207
14.5	Mechanical dimensions PL/X 5 - 50.....	208
14.6	Mechanical dimensions PL/X 65 - 145 .....	209
14.7	Mechanical dimensions PL/X 185 - 265 .....	210
14.8	Line reactors .....	212
14.9	Wiring instructions.....	213
14.9.1	Wiring diagram for AC supply to L1/2/3 different to EL1/2/3. (E.g. Low voltage field).....	213
14.10	Terminal tightening torques .....	214
14.11	Installation guide for EMC .....	215
14.11.1	3-phase power supply port .....	215
14.11.2	Earthing and screening guidelines .....	215
14.11.3	Earthing diagram for typical installation .....	216
14.11.4	Guidelines when using filters .....	217
14.12	Approvals UL, cUL, CE .....	217
14.12.1	CE Immunity.....	217
14.12.2	CE Emissions.....	217
14.12.3	UL, cUL .....	217
14.13	What to do in the event of a problem .....	218
14.13.1	A simple clarification of a technical issue.....	218
14.13.2	A complete system failure .....	218

## 14.1 Product rating table

Model PL 2Q PLX 4Q	Output power			Max continuous Current (AMPS)		Maximum field output current (DC Amps)		Main fuses max I <sup>2</sup> t	Maximum Auxiliary Fuse ratings		Line reactor type	Cooling air flow and dissipation	
	At 460V		At 500V	Input AC	Output DC	Standard	Option		Amp	I <sup>2</sup> t		cfm	watts
	Kw	HP	HP										
PL/X5	5	7	7.5	10	12	8		600	20	365	LR48	17	45
PL/X10	10	13	15	20	24	8		600	20	365	LR48	17	80
PL/X15	15	20	20	30	36	8		600	20	365	LR48	17	120
PL/X20	20	27	30	40	51	8		5000	20	365	LR48	17	120
PL/X30	30	40	40	60	72	8		5000	20	365	LR120	35	200
PL/X40	40	53	60	80	99	8		5000	20	365	LR120	35	300
PL/X50	50	67	75	100	123	8		11850	20	365	LR120	35	320
PL/X65	65	90	100	124	155	16		60000	20	365	LR270	60	350
PL/X85	85	115	125	164	205	16		60000	20	365	LR270	60	475
PL/X115	115	155	160	216	270	16		128000	20	365	LR270	60	650
PL/X145	145	190	200	270	330	16		128000	20	365	LR330	60	850
PL/X185	185	250	270	350	430	32	50	240000	50	5000	LR430	180	1000
PL/X225	225	300	330	435	530	32	50	240000	50	5000	LR530	180	1300
PL 265	265	360	400	520	630	32	50	306000	50	5000	LR630	180	1600

### Notes

- 1) Only use UL fuses for installations complying with UL codes.
- 2) 2Q models PL/5/10/15/20/30/40/50/145/225 have a regenerative stopping capability.
- 3) The PL/X 185/225/265 requires 3 auxiliary fuses, (max ratings 50A, I<sup>2</sup>t 5000), standard type CH00850A.
- 4) The standard auxiliary fuses in the above table are chosen for the I<sup>2</sup>t rating. When selecting alternative types the fuse current rating must be at least 1.25 X the field current rating of the motor. The I<sup>2</sup>t rating of the fuse must not exceed the figure in the table.
- 5) Please consider the total component dissipation within the enclosure when calculating the required air throughput. This includes the fuses, line reactors and other sources of dissipation. See 14.8 Line reactor and 14.3 Semiconductor fuse ratings for component dissipation ratings.
- 6) 35 Cubic feet per minute is approximately equivalent to 1 cubic metre per minute.  
180 Cubic feet per minute is approximately equivalent to 6 cubic metres per minute.
- 7) The output power rating shown is at the 100% rating of the drive and is the power available at the shaft for a typical motor. The actual power available will depend on the efficiency of the motor.
- 8) The high power field output option is an extra cost facility and needs to be specified at the time of order.

## 14.2 Product rating labels

The product rating labels are located on the unit under the upper end cap. The product serial number is unique and can be used by the manufacturer to identify all ratings of the unit. The power ratings and model type are also found here, along with any product standard labels applicable to the unit.

## 14.3 Semiconductor fuse ratings

**WARNING. All units must be protected by correctly rated semi-conductor fuses. Failure to do so will invalidate warranty.**

In general the input AC supply current per phase is 0.8 times the DC output current, and the fuse rating should be approx. 1.25 times the input AC current. The fuses specified in this table have been rated to include the 150% overload capability and operate up to 50C ambient at the maximum drive rating. To select a fuse at other ratings (E.g. when using a motor rated at a lower power than the drive unit or operating at a reduced maximum current limit setting) select a fuse with a current rating closest to the armature current and with an I<sup>2</sup>t rating less than the maximum shown in the table. If a DC fuse is fitted in series with the armature it must be a DC rated semiconductor type with current rating 1.2 times the motor full load current, DC voltage rating suitable for the maximum armature voltage and with an I<sup>2</sup>t rating less than the maximum shown in the table. See 14.3.3 DC semi-conductor fuses.

The rated current for semiconductor fuses is normally given by the fuse manufacturers for copper conductors that have a current density in the order of 1.3 - 1.6 A/mm (IEC 269-4). This low utilisation results in extra copper costs during the installation of high current systems, but helps to prevent overheating of the fuses. Alternatively it is possible to use a fuse of a higher rating, and derate it for use in standard fuseholders and installations. This derating factor is only applied to large fuses for the models PL/X 185/225/265. Hence the fuses in the table for these models have been selected with a further derating to approx. 80% in order that they may be used in a standard fuseholder. No derating is required for installations that do comply with IEC 269-4, and in this case a smaller fuse could be selected in accordance with the recommendations given above.

#### 14.3.1 Proprietary fuses

Model PL 2Q PLX 4Q	Max cont Current (AMPS)		Main fuses max I <sup>2</sup> t	LITTLEFUZE		BUSS	BUSS EU	IR American style	IR BS88	IR DIN
	IP AC	OP DC		Up to 250V ac supply	Up to 500V ac supply	Up to 500V ac supply	Up to 500V ac supply	Up to 500V ac supply	Up to 250V ac supply	Up to 500V ac supply
PL/X5	10	12	600	L25S 12	L50S 12	FWH 12	FWH20A14F	XL50F015	L350-12	661RF0025
PL/X10	20	24	600	L25S 25	L50S 25	FWH 25	170L1013	XL50F025	L350-25	661RF0025
PL/X15	30	36	600	L25S 40	L50S 40	FWH 40	170L1013	XL50F040	L350-40	661RF0035
PL/X20	40	51	5000	L25S 50	L50S 50	FWH 50	170M1564	XL50F050	L350-50	661RF0050
PL/X30	60	72	5000	L25S 80	L50S 80	FWH 80	170M1566	XL50F080	L350-80	661RF0080
PL/X40	80	99	5000	L25S 100	L50S 100	FWH 100	170M1567	XL50F100	L350-100	661RF00100
PL/X50	100	123	11850	L25S 125	L50S 125	FWH 125	170M1568	XL50F125	L350-125	661RF00125
PL/X65	124	155	60000	L25S 175	L50S 175	FWH 175	170M1569	XL50F175	L350-180	661RF00160
PL/X85	164	205	60000	L25S 225	L50S 225	FWH 250	170M3816	XL50F250	T350-250	661RF00250
PL/X115	216	270	128000	L25S 275	L50S 275	FWH 300	170M3816	XL50F300	T350-315	661RF00315
PL/X145	270	330	128000	L25S 350	L50S 350	FWH 350	170M3818	XL50F350	T350-355	661RF00350
PL/X185	350	430	240000	L25S 450	L50S 450	FWH 450	170M5809	XL50F450	TT350 -500	661RF00450
PL/X225	435	530	240000	No fuse available	L50S 550	FWH 600	170M5811	XL50F600	TT350 -630	661RF2 630
PL 265	520	630	306000	No fuse available	No fuse available	FWH 700	170M5811	XL50F700	TT350 -710	661RF2 700

#### 14.3.2 European stock fuses

Model PL 2Q PLX 4Q	Max IP AC Amps	Main fuses max I <sup>2</sup> t	STOCK part number				
			MAIN FUSE 3 fuses required	MAIN FUSE Single pole holder 3 required		AUX FUSE 3 fuses required	AUX FUSE Single pole holder 3 required
PL/X5	10	600	CH00612A	CP102071	14 X 51	CH00620A	CP102071
PL/X10	20	600	CH00740A	CP102053	Size 00	CH00620A	CP102071
PL/X15	30	600	CH00740A	CP102053	Size 00	CH00620A	CP102071
PL/X20	40	5000	CH00850A	CP102054	Size 00	CH00620A	CP102071
PL/X30	60	5000	CH00880A	CP102054	Size 00	CH00620A	CP102071
PL/X40	80	5000	CH008100	CP102054	Size 00	CH00620A	CP102071
PL/X50	100	11850	CH008125	CP102054	Size 00	CH00620A	CP102071
PL/X65	124	60000	CH008160	CP102054	Size 00	CH00620A	CP102071
PL/X85	164	60000	CH009250	CP102055	Size 1	CH00620A	CP102071
PL/X115	216	128000	CH009250	CP102055	Size 1	CH00620A	CP102071
PL/X145	270	128000	CH010550	CP102233	Size 3	CH00620A	CP102071
PL/X185	350	240000	CH010550	CP102233	Size 3	CH00850A	CP102054
PL/X225	435	240000	CH010550	CP102233	Size 3	CH00850A	CP102054
PL 265	520	306000	CH010700	CP102233	Size 3	CH00850A	CP102054

## 14.3.3 DC semi-conductor fuses

If the load regenerates or regenerative braking is employed, then a DC rated armature fuse with the correct  $I^2t$  rating in series with the motor armature is highly recommended.

Model PL 2Q PLX 4Q	Max cont Current (AMPS)		DC fuse max $I^2t$	BUSSMAN EU				Ferraz Shawmut			
				Up to 500V DC				Up to 500V DC UL			
	IP AC	OP DC		Rating	$I^2t$	Buss part no	size	Rating	$I^2t$	Ferraz part no	size
PL/X5	10	12	600	16A	48	170M1559	1	35A	360	A50QS35-4	1
PL/X10	20	24	600	32A	270	170M1562	1	35A	360	A50QS35-4	1
PL/X15	30	36	600	40A	270	170M3808	1	40A	460	A50QS40-4	1
PL/X20	40	51	5000	63A	770	170M3810	1	60A	1040	A50QS60-4	1
PL/X30	60	72	5000	80A	1250	170M3811	1	80A	1900	A50QS80-4	1
PL/X40	80	99	5000	125A	3700	170M3813	1	100A	2900	A50QS100-4	1
PL/X50	100	123	11850	160A	7500	170M3814	1	125A	5000	A50QS150-4	1
PL/X65	124	155	60000	200A	15000	170M3815	1	200A	13000	A50QS200-4	1
PL/X85	164	205	60000	250A	28500	170M3816	1	250A	24000	A50QS250-4	1
PL/X115	216	270	128000	315A	46500	170M3817	1	350A	47000	A50QS350-4	1
PL/X145	270	330	128000	400A	105000	170M3819	1	400A	61000	A50QS400-4	2
PL/X185	350	430	240000	500A	145000	170M5810	2	500A	97000	A50QS500-4	2
PL/X225	435	530	240000	550A	190000	170M5811	2	600A	140000	A50QS600-4	2
PL 265	520	630	306000	630A	275000	170M5812	2	Consult Ferraz Shawmut.			

The above fuses are specified for operation up to 500V DC for armature circuit time constants up to 10mS.

The table below gives maximum typical operating voltage for various time constants. (inductance/resistance)  
Please refer to the fuse manufacturers data for further information

Maximum working DC voltage	Maximum allowable time constant
500	10mS
450	20mS
400	30mS
380	40mS
360	50mS

#### 14.4 PL/X family cover dimensions

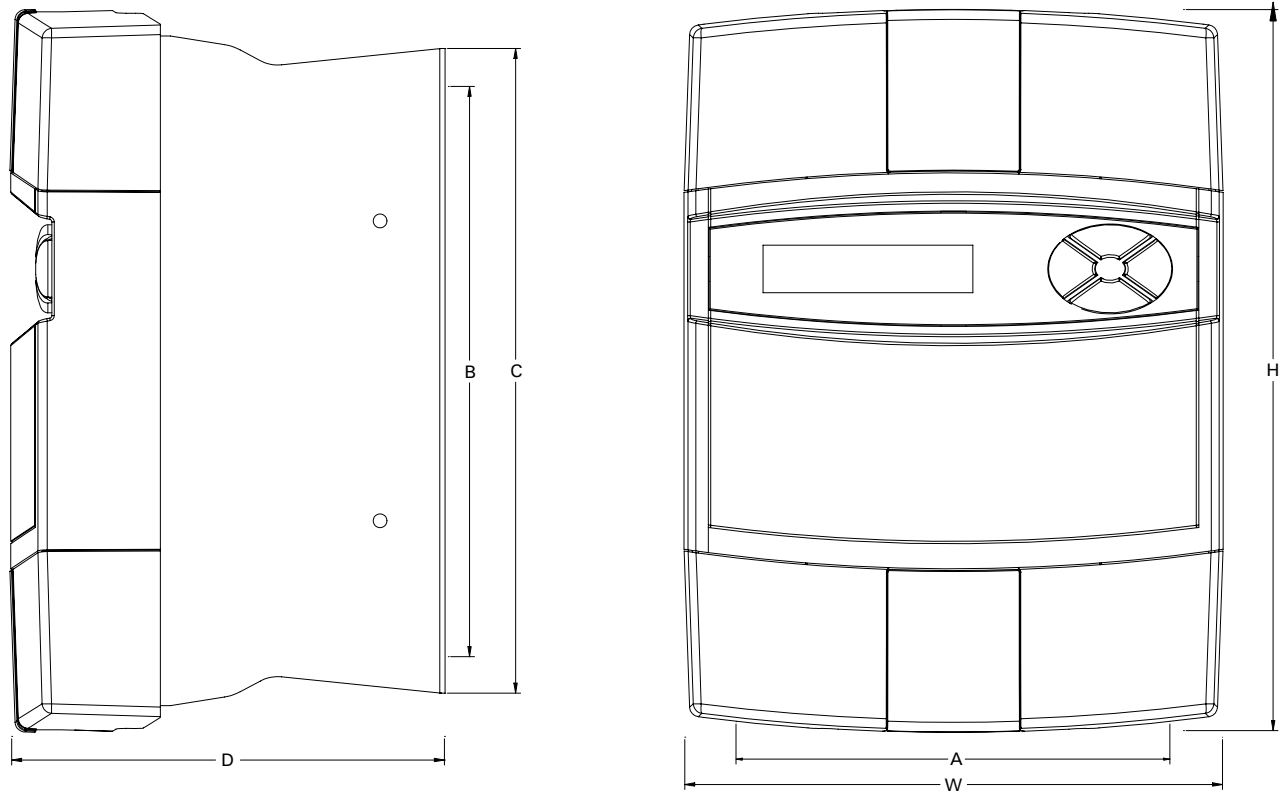

Dimension in mm	PL/X 5-50	PL/X65-145	PL/X185/265
W	216	216	216
H	289	378	378
D	174	218	294
A fixing centre	175	175	175
B fixing centre	228	390	390
C	258	410	410

See 14.5, 14.6 and 14.7 for unit footprint and busbar dimensions.

### 14.5 Mechanical dimensions PL/X 5 - 50

Unit weight 5Kg

Symbolic drawing shown with end caps removed

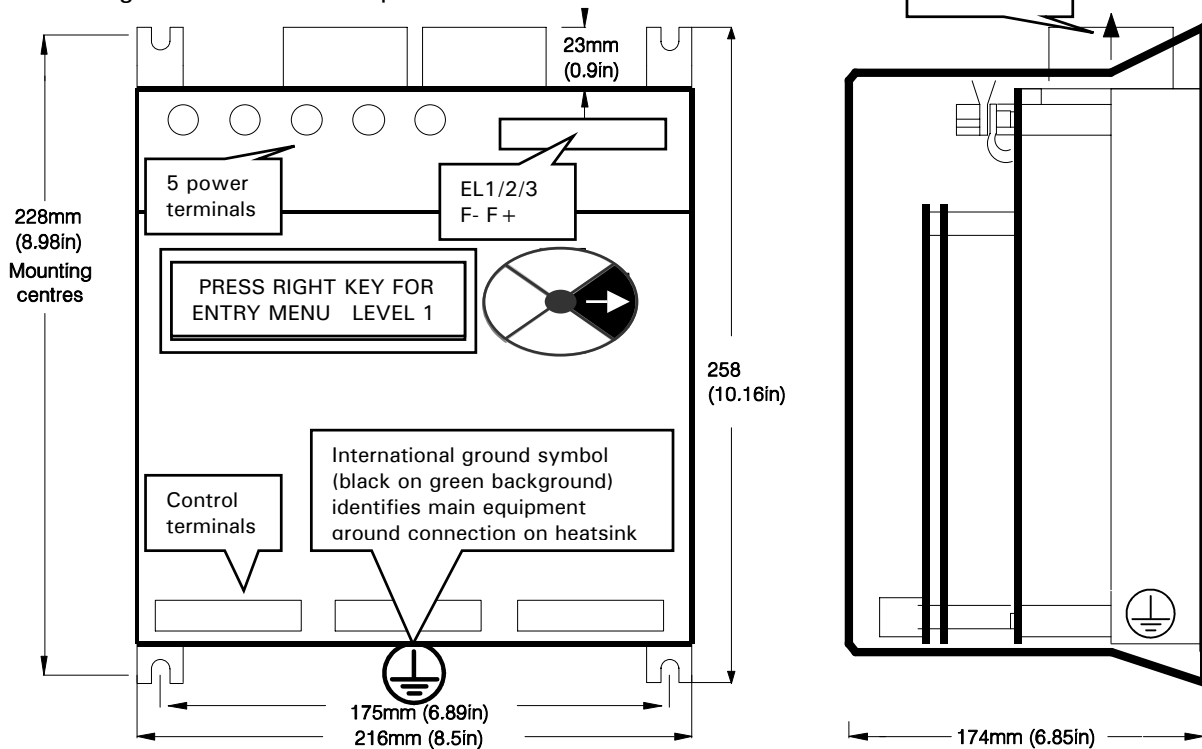

#### 14.5.1.1 Mounting PL/X 5 - 50

Four corner slots are provided to mount the unit. Use M6 (1/4 in) screws.

**All mounting hole dimensions are +/- 2 mm.**

A substantial earth connection should be made to the busbar provided.

Nominal cooling air throughput is specified in the rating table. (Use cool, clean, dry, filtered air).

Do not block the heatsink fins. Allow at least 50mm (2 in) space above and below the unit.

Ensure connections to power terminals are tight. Power terminal fastenings are M6.

See 14.10 Terminal tightening torques.

The units must be orientated vertically as shown.

**Unit weight 5Kg**



### 14.6 Mechanical dimensions PL/X 65 - 145

Unit weight 11Kg

Symbolic drawing shown with end caps removed

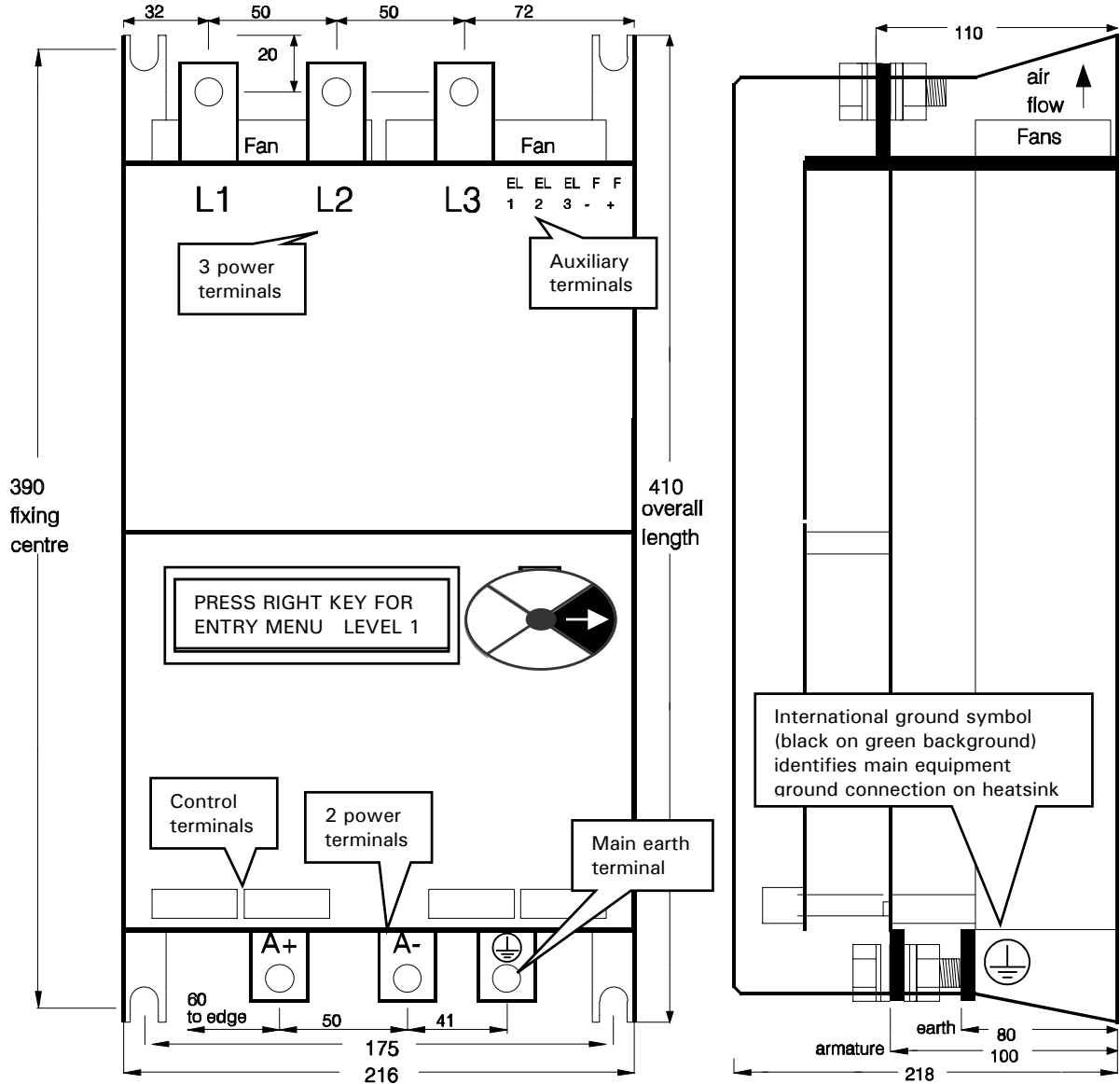

#### 14.6.1.1 Mounting PL/X 65 - 145

Four corner slots are provided to mount the unit. Use M8 (5/16 in) screws.

**All mounting hole dimensions are +/- 2 mm.**

A substantial earth connection should be made to the busbar provided.

Nominal cooling air throughput is specified in the rating table. (Use cool, clean, dry, filtered air).

Do not block the heatsink fins. Allow at least 100mm (4 in) space above and below the unit.

Ensure connections to power terminals are tight. Power terminal fastenings are M10

See 14.10 Terminal tightening torques.

**Mount the main contactor so as to avoid mechanical operating shock being transmitted to PL/X busbars.**

**E. g. Ensure Line reactor is fitted between contactor and PL/X.**

The units must be orientated vertically as shown.

Unit weight 11Kg

## 14.7 Mechanical dimensions PL/X 185 - 265

Unit weight 17Kg. Symbolic drawing shown with end caps removed

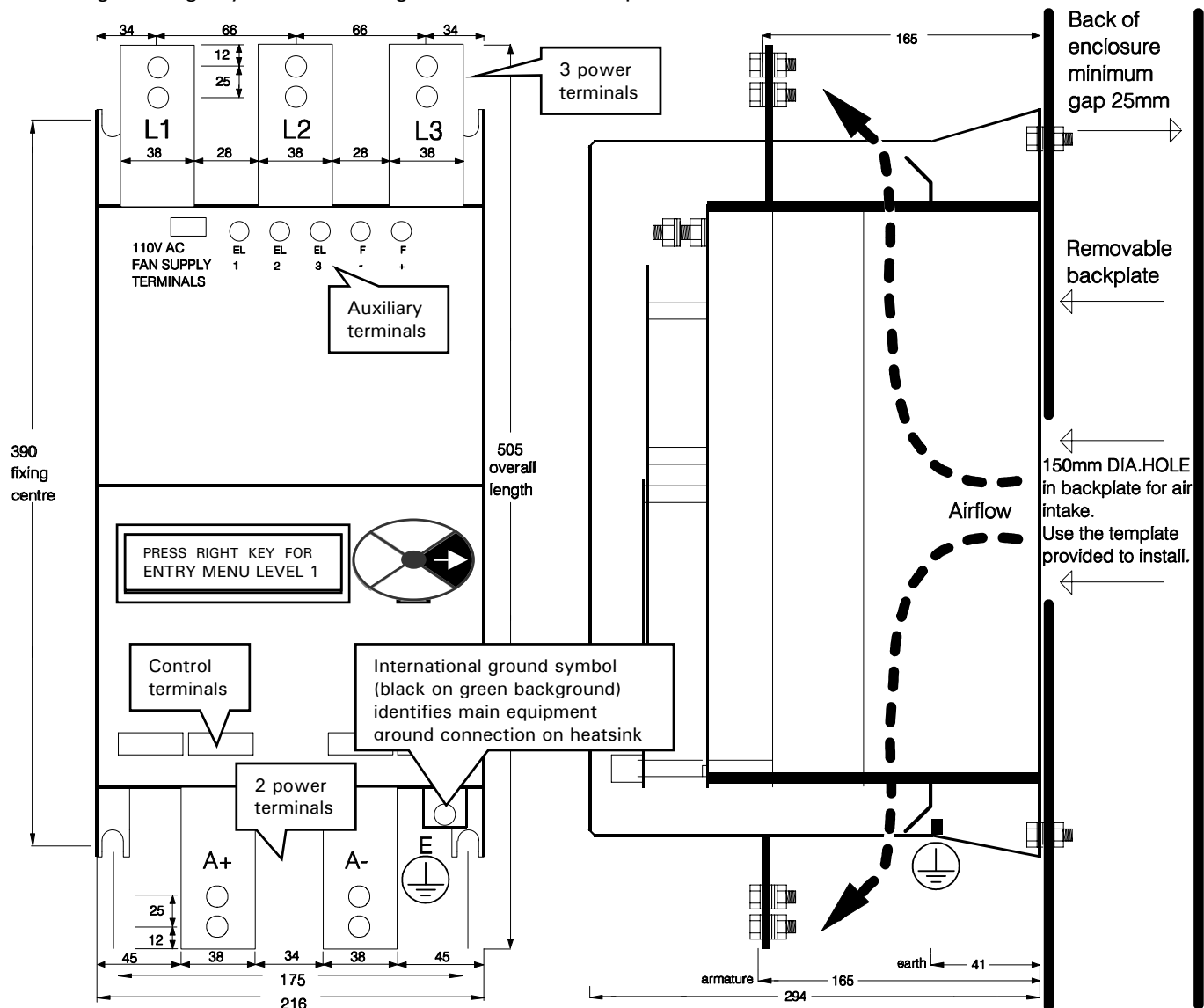

### 14.7.1.1 Mounting PL/X 185 - 265

Four corner slots are provided to mount the unit. Use M8 (5/16 in) screws.

**All mounting hole dimensions are +/- 2 mm.**

A substantial earth connection should be made to the busbar provided.

Nominal cooling air throughput is specified in the rating table. (Use cool, clean, dry, filtered air).

Allow at least 100mm (4 in) space above and below the unit.

Ensure connections to power terminals are tight. Power terminal fastenings are M10.

See 14.10 Terminal tightening torques.

**Mount the main contactor so as to avoid mechanical operating shock being transmitted to PL/X busbars.**

**E. g. Ensure Line reactor is fitted between contactor and PL/X.**

The units must be orientated vertically as shown.

A template is provided to assist in cutting the venting aperture.

These models require an additional 110V AC 50VA fused supply for the main fan. The connection terminals are at the top left hand corner of the unit.

The first time the unit is used and the main contactor energised, confirm that the internal fan is operating.

This will be evident by a strong airflow over the top and bottom busbars towards the front of the enclosure

**Unit weight 17Kg**

14.7.1.2 Venting models PL/X 185 - 265 using back panel aperture

Use the template provided to assist in cutting the aperture in the back panel

This is the preferred method of mounting because it allows the maximum amount of cool air to flow over the heatsink of the drive.

For installations requiring a 50C internal enclosure ambient this method is necessary.

The source of clean, filtered, cool, dry air for venting the unit must arrive at the bottom of the enclosure. It must then be able to flow freely to the rear of the backplate as shown. There must be no obstructions to the flow of air on its journey to the back aperture. There is a very powerful fan integral to the PL/X which will suck this air into the rear of the unit. After passing over the heatsink it is exhausted at the top and bottom of the unit. The exhaust air must then be extracted from the enclosure via roof mounted fans capable of a throughput rate specified in the rating table. Note, when calculating the required air throughput, it is necessary to consider the dissipation of all heat generating components. The dissipation in watts for the PL/X, main fuses and line reactors, is provided in the relevant sections.

See 14.1 Product rating table.

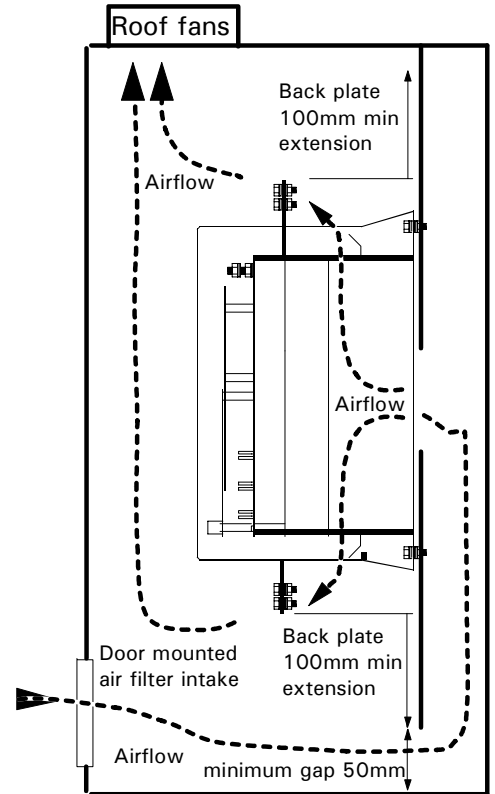

14.7.1.3 Venting models PL/X 185 - 265 using standoff pillars

This method of mounting may be the only practical technique in retrofit installations where cutting an aperture in the back panel is not possible.

The unit is provided with a mounting kit consisting of four 50mm pillars. The maximum enclosure ambient temperature using this method is 35C. There must be no obstructions to the flow of air on its journey to the rear of the PL/X.

The reason for the reduced ambient rating is that some of the exhaust air may be recirculated over the heatsink, leading to a loss of efficiency. Any steps that can be taken to minimise this are advantageous. (The 35C rating applies to installations where there is not complete separation of the incoming air from the cooling air).

If it is possible to provide an air duct with an aperture area of greater than 180 sq. cm. that can transport air unimpeded to the rear of the PL/X, then this solution is as effective as the back panel aperture method described above.

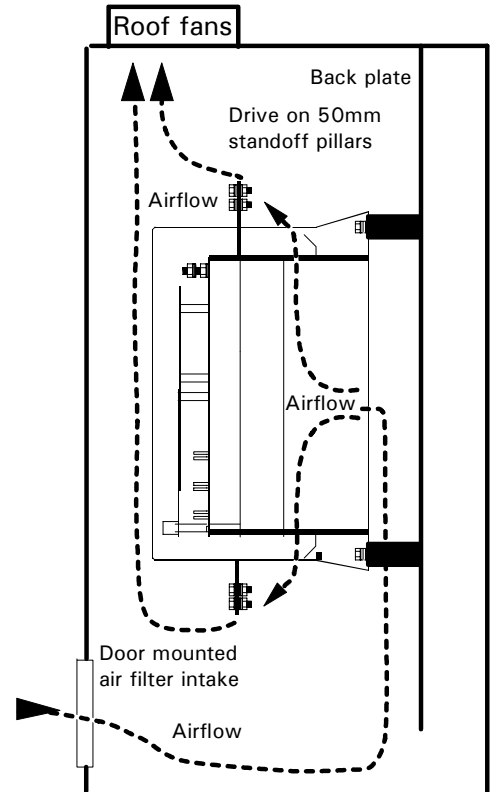

## 14.8 Line reactors

Only use CSA/UL certified line reactors for installations complying with CSA/UL codes. These line reactors are not certified. Refer to supplier for certified alternatives.

Model PL 2Q PLX 4Q	Output power			Max continuous Current (AMPS)		Line reactor Type
	At 460V		At 500V	Input AC	Output DC	
	Kw	HP	HP			
PL/X5	5	7	7.5	10	12	LR48
PL/X10	10	13	15	20	24	LR48
PL/X15	15	20	20	30	36	LR48
PL/X20	20	27	30	40	51	LR48
PL/X30	30	40	40	60	72	LR120
PL/X40	40	53	60	80	99	LR120
PL/X50	50	67	75	100	123	LR120
PL/X65	65	90	100	124	155	LR270
PL/X85	85	115	125	164	205	LR270
PL/X115	115	155	160	216	270	LR270
PL/X145	145	190	200	270	330	LR330
PL/X185	185	250	270	350	430	LR430
PL/X225	225	300	330	435	530	LR530
PL 265	265	360	400	520	630	LR630

To obtain line reactor dimensions

Please refer to [www.sprint-electric.com](http://www.sprint-electric.com) Downloads – Technical data and software.

## 14.9 Wiring instructions

**Note.** The PL/X controller is an open chassis component for use in a suitable enclosure. Only qualified personnel should install, commission and service this apparatus according to the safety codes in force.

1) All units must be protected by correctly rated semi-conductor fuses. (3 main fuses and 3 auxiliary fuses)

**Failure to do so will invalidate warranty.** See 14.3 Semiconductor fuse ratings. A DC armature fuse for regenerative applications is highly recommended. See 14.3.3 DC semi-conductor fuses.

2) Power wiring should utilise cables with a minimum rating of 1.25 X full load current. Control wiring should have a minimum cross-section of  $0.75\text{mm}^2$ . Copper conductors must be rated 60C, or 75C over 100 Amps.

**3) A substantial ground or earth connection should be made to the earth terminal on the drive identified by the international ground symbol. A control clean protective earth connection must be made to terminal 13.**

4) A 3 phase contactor must be connected in the main AC supply with suitable voltage and current ratings. (AC1). The contactor is not required to switch current and is employed in the sequencing and carrying of power to the unit. The contactor coil must be provided with a suitable control supply which is applied by the controller to the contactor coil using terminals 45 and 46. **If for safety reasons it is mandated that the contactor coil must be able to be de-energised externally to the drive, then it must be arranged that the CSTOP terminal 35 is opened at least 100ms prior to the opening of the main contactor.** Failure to achieve this will prevent the armature current from being able to commutate to zero prior to supply removal and may result in damage to the unit. **Failure to heed this warning will invalidate warranty.** See 4.3 Main contactor wiring options, for advice on using DC side contactors, or other power sequencing options.

5) For contactor coils with a VA rating that exceeds the ratings of terminals 45 and 46, it is necessary to utilise a slave relay of suitable rating to drive the contactor coil.

**Note.** If the users main contactor has a final closing time delay of greater than 75ms, then it is essential that an auxiliary normally open contact on the main contactor is inserted in series with the RUN input on T31, alternatively use contactor wiring method shown in 4.3.2.

This will prevent the unit from trying to deliver power until the main contact has closed.

6) A 3 phase line reactor must be in series with the AC supply, between the contactor and power terminals. This also helps to avoid main contactor mechanical operating shock being transmitted to PL/X busbars.

7) The phase rotation of the 3 phase supply is not important. **However it is essential that there is phase equivalence for L1 to EL1, L2 to EL2 and L3 to EL3.** Particular care must be taken if L1/2/3 and EL1/2/3 are fed from different sides of a transformer. If the transformer is star delta then there will be a phase mismatch and the unit will fail to operate correctly. Only use star - star or delta - delta transformers.

**8) For units with regenerative capability it will be necessary to fit a DC side semi-conductor fuse. This will protect the unit in the event of an unsequenced power loss when regeneration is taking place.**

9) All connections to control terminals 1 to 36 must be referred to earth.

**10) If it is necessary to perform high voltage or dielectric tests on the motor or wiring, then the drive unit must be disconnected first. Failure to do so will invalidate warranty.**

### 14.9.1 Wiring diagram for AC supply to L1/2/3 different to EL1/2/3. (E.g. Low voltage field)

It is not uncommon for the armature voltage and the field voltage of motors to be sufficiently different to merit supplying them with different levels of AC voltage. This is particularly true for old motors.

The PL/X is provided with independent control bridges and supply inputs for the armature (L1/2/3) and field (EL1/2/3). Normally the L1/2/3 and EL1/2/3 ports are fed with the same AC supply voltage, and if for example, the field voltage is lower than would normally be expected for the prevailing supply, then the control loop will phase back the output voltage accordingly.

However when the difference becomes excessive it may be preferable to feed the 2 power ports from different supply voltages. The reason for this is usually to prevent high peak voltages from being imposed on a winding where the supply voltage is much higher than the winding rating. Also a winding that was designed to run at full voltage fully phased forward, will be subjected to a worse form factor when run continuously phased right back, leading to overheating.

The wiring diagram below shows the preferred method of supplying the ports with different AC voltages. It uses a single phase isolated transformer from L2 / 3 levels to EL2 / 3 to suit field.

E. g. The motor armature may be rated at 460V DC to be supplied from a 415V AC supply, and the field voltage may be rated at 100V DC, originally designed to be supplied from a rectified 110V AC supply.

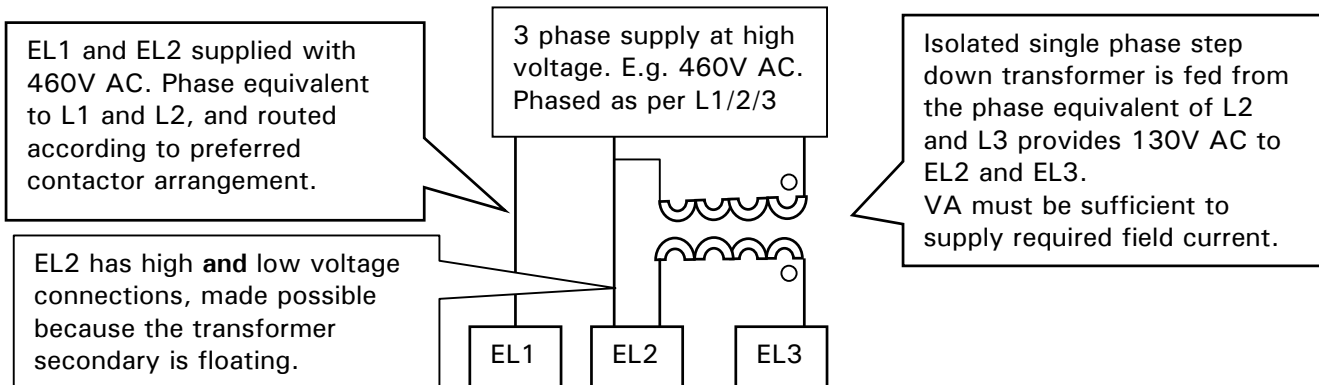

The advantages of this method are: -

- 1) Only requires low cost easily available single phase transformer.
- 2) The EL1/2 connections do not suffer any phase lags or leads because they are still connected as per standard schemes. This is important because the synchronisation is sensed through EL1/2.

**Note.**

- 1) This scheme works equally well for step up or down transformers.
- 2) The phase equivalence of EL1/2/3 must always relate to L1/2/3.
- 3) The field voltage required in the above example is 100V, probably originally designed to be operated from a rectified 110V supply. However with the ability to control the field current available within the PL/X, it is preferable to feed the field supply with a higher voltage, e.g. 130V. This provides the control loop with a supply margin in order to control more effectively.

**WARNING.** The field to earth voltage of the motor must be rated for the voltage applied to EL2.

4) See 6.1.16 CALIBRATION / EL1/2/3 rated AC volts PIN 19 QUICK START.

**This must be set to the lower of the two AC voltages, which would be 130V AC in the above example.**

**WARNING.** 8.1.11.11 DRIVE TRIP MESSAGE / Supply phase loss. This detector may then be ineffective for loss of EL1. However 8.1.11.12 DRIVE TRIP MESSAGE / Synchronization loss will detect a loss on EL1.

5) See 4.3 Main contactor wiring options for details of wiring to L1/2/3 according to contactor requirements.

**14.10 Terminal tightening torques**

Terminals	Model	Tightening torque
Terminals 1 to 100	PL/X 5-265	4 lb-in or 0.5 N-m
EL1 EL2 EL3 F+ F-	PL/X 5-145	9 lb-in or 1.0 N-m
EL1 EL2 EL3 F+ F-	PL/X 185-265	35 lb-in or 3.9 N-m
L1 L2 L3 A+ A-	PL/X 5-50	35 lb-in or 3.9 N-m
L1 L2 L3 A+ A-	PL/X 65-265	242 lb-in or 27 N-m
Fan terminals	PL/X 185-265	9 lb-in or 1.0 N-m

## 14.11 Installation guide for EMC

Special consideration must be given to installations in member states of the European Union regarding noise suppression and immunity. According to IEC 1800-3 (EN61800-3) the drive units are classified as Basic Drive Modules (BDM) only for professional assemblers and for the industrial environment. Although CE Marking is made against the EMC Directive, application of EN 61800-3 means that no RF emission limits apply. The drive manufacturer is responsible for the provision of installation guidelines. The resulting EMC behaviour is the responsibility of the manufacturer of the system or installation. The units are also subject to the LOW VOLTAGE DIRECTIVE 73/23/EEC and are CE marked accordingly.

Following the procedures outlined will normally be required for the drive system to comply with the European regulations, some systems may require different measures.

Installers must have a level of technical competence to correctly install. Although the drive unit itself does not require control of RF emissions, it has been designed and tested to comply with the most stringent emissions and immunity requirements on all ports.

### 14.11.1 3-phase power supply port

The 3-phase power supply port is subject to alternative guidelines, as described below. Compliance with emissions limits on this port may or may not be required depending on the environment. If required then compliance can be achieved by fitting a separate filter unit, contact supplier for details.

EN61800-3 specifies 2 alternative operating environments. These are the domestic (1<sup>st</sup> environment) and industrial (2<sup>nd</sup> environment). There are no limits specified for conducted or radiated emissions in the Industrial environment, hence it is usual for the filter to be omitted in industrial systems.

Definition of an industrial environment: Includes all establishments other than those directly connected to a low voltage power supply network which supplies buildings used for domestic purposes.

In order to meet mains conducted emissions limits on this port for the 1<sup>st</sup> environment, a separate filter is required. Please refer to supplier for a suitable filter to meet the Class A (EN 61800-3 restricted distribution, domestic environment).

### 14.11.2 Earthing and screening guidelines

Important points to note are:

A separate earth conductor is taken from the motor housing and is run adjacent to the drive conductors right up to the main earth terminal on the drive. This conductor should not be grounded separately to any other earth point.

The drive earth terminal should be separately taken to the cabinet star earth point or earth busbar, as should the 0V connection reference at Terminal 13.

Motor drive and three-phase supply cables should be segregated from other cables in the cabinet, preferably by a distance of at least 300mm.

Motor drive cables can be screened or armoured, especially if they pass near other sensitive apparatus, and the screening should be bonded to the motor housing and the point of entry of the cabinet using 360° gland techniques.

It is understood that the bonding of both ends of the screening and earth conductors may result in significant earth current flow if the motors and control cabinet are in widely different locations, so that there are large earth potential differences. In these circumstances it is recommended that a separate parallel earth conductor (PEC), which may be a bonded metal conduit, is used alongside the drive cables to give a preferential route for this current. See IEC 61000-5-2 for more detail. Installation in conformance with this standard is regarded as good practice and will result in improved EMC of the whole system.

**WARNING Safety earthing always takes precedence over EMC earthing.**

14.11.3 Earthing diagram for typical installation

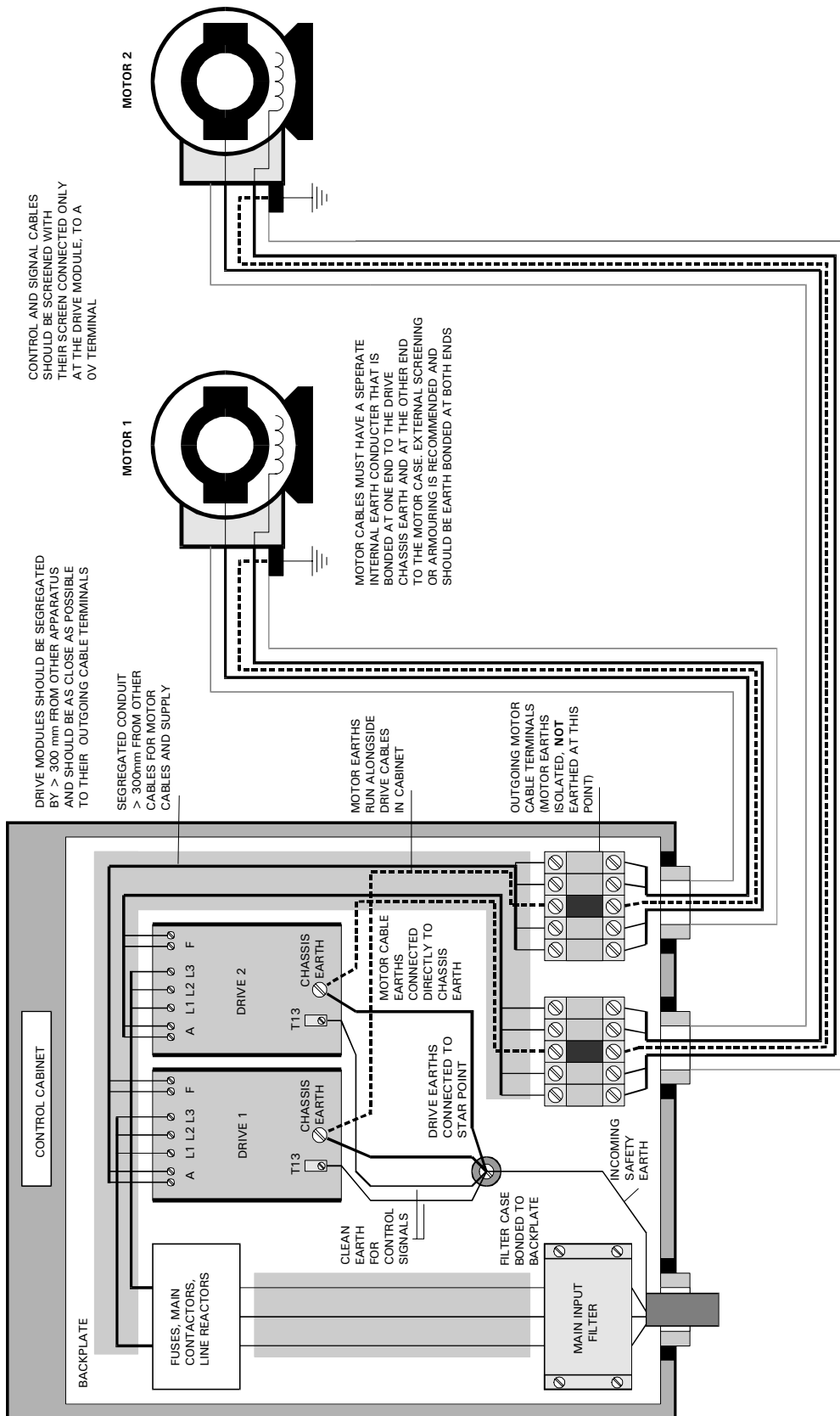



## 14.11.4 Guidelines when using filters

	<b>IMPORTANT SAFETY WARNINGS</b>	
	<p>The AC supply filters must not be used on supplies that are un-balanced or float with respect to earth</p>	<p>The drive and AC filter must only be used with a permanent earth connection. No plugs/sockets are allowed in the AC supply</p>

- 1) The AC connections from the filter to the drive must be less than 0.3m or if longer correctly screened.
- 2) The AC filter, drive earth and motor cable screen should connect directly to the metal of the cabinet.
- 3) Do not run filtered and unfiltered AC supply cables together.
- 4) The AC input filter has earth leakage currents. RCD devices may need to be set at 5% of rated current.
- 5) The AC supply filter must have a good earth connection to the enclosure back plane. Take care with painted metal. Remove paint and ensure good connection.

**14.12 Approvals UL, cUL, CE****EMC Compliance statement for PL/X**

This apparatus complies with the protection requirements of the EMC Directive 89/336/EEC as follows:

## 14.12.1 CE Immunity

The unit complies with the following standards:

EN 50082-2:1995 - generic immunity standard - industrial environment

EN 50082-1:1997 - generic immunity standard - residential, commercial and light industry

EN 61800-3:1996 and prA I 1: 1999 - Adjustable speed electrical power drive systems - EMC product standard including specific test methods - first and second environments

Performance criteria:

No change of state or stored data, temporary variation in analogue input or output level < 1%

## 14.12.2 CE Emissions

Control supply port and control signal port:

Conducted and radiated emissions comply with the following standards-

EN 50081-2:1993 - generic emissions standard - industrial environment (EN 55011 Class A)

EN 50081-1:1992 - generic emissions standard - industrial environment (EN 55022 Class B)

EN 61800-3:1996 and prA 1 1: 1999 - Adjustable speed electrical power drive systems - EMC product standard including specific test methods - first and second environments, restricted or unrestricted distribution.

Mains harmonics: The control supply port active input power is less than 50W with the class D waveshape and therefore meets EN 61000-3-2:1995 with no limits applied.

3-phase motor supply port:

Class B (EN 61800-3 unrestricted distribution, industrial environment) limits. No filter required.

In order to meet Class A (EN 61800-3 restricted distribution, domestic environment) mains conducted emissions limits on this port, a separate filter is required. Please refer to supplier.

## 14.12.3 UL, cUL

The PL/X range is UL and cUL listed. File number E168302

### 14.13 What to do in the event of a problem

If there is a problem with the PL/X that you cannot solve without assistance then it may be necessary for you to contact the equipment supplier for help. Problems can vary between :-

1) A simple clarification of a technical issue, to 2) A complete system failure.

#### 14.13.1 A simple clarification of a technical issue

Problems of the first variety can normally be resolved quickly by telephone, fax or email. When sending information about your enquiry please include the following information.

- a) The product serial number. This is found under the top end cap.
- b) The software version number (if possible). See 11.5 Remotely mounted display unit.

If you are making a telephone enquiry please have this manual to hand at the time of the call.

#### 14.13.2 A complete system failure

For more serious problems of the 2<sup>nd</sup> variety it is necessary for you to provide the following information, or if making a telephone call, have the information to hand. The engineer providing assistance may ask you to send some or all of this to him.

- a) The product serial number. This is found under the top end cap.
- b) The software version number (if possible). See 11.4 DISPLAY FUNCTIONS / Software version.
- c) Wiring diagram of the PL/X installation with details of external signals connected to the PL/X.
- d) Machine schematic with details of intended function of motor being driven by the PL/X.
- e) All possible motor details.
- f) Precise description of fault condition including any alarm messages issued by the PL/X.
- g) If possible, any information about the operating conditions prior to, and at, the point of the failure.
- h) A menu listing or a list of parameters that have been changed from the default values. Or recipe file.
- i) Is the PL/X being commissioned for the first time. If so have you ticked the boxes in section 4.4 ESSENTIAL pre-start checks.

The engineer providing assistance is aware of the prime importance of providing a solution, and also understands, through experience, that you may be working in hostile conditions.

#### **WARNING**

**Take careful note of all the information in section 2 Warnings, and in particular section 2.3 General Risks when performing measurements and investigating failures. This applies to electrical and mechanical systems.**

## 15 PIN number tables

### 15.1 Numeric tables

Key to PROPERTIES. R=in REDUCED MENU, P=Not changed by 4-key reset, S=STOP DRIVE TO ADJUST

#### 15.1.1 Change parameters 2 - 121

Property	Paragraph	Menu / Description	Range	Default	PIN
		Reserved			1
R/P/S	6.1.2	CALIBRATION / Rated armature amps PIN 2 QUICK START	33% -100%	33% Amps	2
R/P	6.1.3	CALIBRATION / Current limit% PIN 3 QUICK START	0 - 150.00%	150.00%	3
R/P/S	6.1.4	CALIBRATION / Rated field amps PIN 4 QUICK START	0.1 - 100% A	25% Amps	4
R/P/S	6.1.5	CALIBRATION / Base rated motor rpm PIN 5 QUICK START	0 - 6000 rpm	1500 rpm	5
R/P	6.1.6	CALIBRATION / Desired max rpm PIN 6 QUICK START	0 - 6000 rpm	1500 rpm	6
R/P	6.1.7	CALIBRATION / Zero speed offset PIN 7	0 - +/-5.00%	0.00%	7
R/P/S	6.1.8	CALIBRATION / Max tachometer volts PIN 8	+/-200.00 V	60.00 V	8
R/P/S	6.1.9	CALIBRATION / Speed feedback type PIN 9 QUICK START	0, 1, 2, 3, 4	0 (AVF)	9
R/P/S	6.1.10.1	ENCODER SCALING / Quadrature enable PIN 10	0 - 1	Disabled	10
R/P/S	6.1.10.2	ENCODER SCALING / Encoder lines PIN 11	1 - 6000	1000	11
R/P/S	6.1.10.3	ENCODER SCALING / Motor / encoder speed ratio PIN 12	0 - 3.0000	1.0000	12
R/P/S	6.1.10.4	ENCODER SCALING / Encoder sign PIN 13	0 - 1	Non-invert	13
R/P	6.1.11	CALIBRATION / IR compensation PIN 14	0 - 100.00 %	0.00%	14
R/P	6.1.12	CALIBRATION / Field current feedback trim PIN 15	1 - 1.1000	1.0000	15
R/P	6.1.13	CALIBRATION / Armature volts trim PIN 16	1 - 1.1000	1.0000	16
R/P	6.1.14	CALIBRATION / Analog tach trim PIN 17	1 - 1.1000	1.0000	17
R/P/S	6.1.15	CALIBRATION / Rated armature volts PIN 18 QUICK START	0 - 1000.0 V	460.0 V	18
R/P/S	6.1.16	CALIBRATION / EL1/2/3 Rated AC volts PIN 19	0 - 1000.0 V	415.0 V	19
R/P	6.1.17	CALIBRATION / MOTOR 1 or 2 select PIN 20	0 - 1	MOTOR 1	20
R	6.2.2	RUN MODE RAMPS / Ramp output monitor PIN 21	+/-100.00%	0.00%	21
R	6.2.3	RUN MODE RAMPS / Forward up time PIN 22	0.1 - 600.0 s	10.0	22
R	6.2.4	RUN MODE RAMPS / Forward down time PIN 23	0.1 - 600.0 s	10.0	23
R	6.2.5	RUN MODE RAMPS / Reverse up time PIN 24	0.1 - 600.0 s	10.0	24
R	6.2.6	RUN MODE RAMPS / Reverse down time PIN 25	0.1 - 600.0 s	10.0	25
	6.2.7	RUN MODE RAMPS / Ramp input PIN 26	+/-105.00%	0.00%	26
	6.2.8	RUN MODE RAMPS / Forward minimum speed PIN 27	0 - 105.00%	0.00%	27
	6.2.9	RUN MODE RAMPS / Reverse minimum speed PIN 28	0 - -105.00%	0.00%	28
	6.2.10	RUN MODE RAMPS / Ramp automatic preset enable PIN 29	0 - 1	Enabled	29
	6.2.11	RUN MODE RAMPS / Ramp external preset enable PIN 30	0 - 1	Disabled	30
	6.2.12	RUN MODE RAMPS / Ramp preset value PIN 31	+/-300.00%	0.00%	31
	6.2.13	RUN MODE RAMPS / Ramp S profile % PIN 32	0.1- 100.00%	2.50%	32
	6.2.14	RUN MODE RAMPS / Ramp hold enable PIN 33	0 - 1	Disabled	33
	6.2.15	RUN MODE RAMPS / Ramping flag threshold PIN 34	0.1- 100.00%	0.50%	34
R	6.2.16	RUN MODE RAMPS / Ramping flag PIN 35	0 - 1	LOW	35
				0	36
R	6.3.2	JOG CRAWL SLACK / Jog speed 1 PIN 37	+/-100.00%	5.00%	37
R	6.3.2	JOG CRAWL SLACK / Jog speed 2 PIN 38	+/-100.00%	-5.00%	38
R	6.3.3	JOG CRAWL SLACK / Slack speed 1 PIN 39	+/-100.00%	5.00%	39
R	6.3.3	JOG CRAWL SLACK / Slack speed 2 PIN 40	+/-100.00%	-5.00%	40
R	6.3.4	JOG CRAWL SLACK / Crawl speed PIN 41	+/-100.00%	10.00%	41
R	6.3.5	JOG CRAWL SLACK / Jog mode select PIN 42	0 - 1	Disabled	42
R	6.3.6	JOG CRAWL SLACK / Jog/Slack ramp PIN 43	0.1 - 600.0 s	1.0 secs	43
				0	44
	6.4.2	MOTORISED POT RAMP / Motor pot output monitor PIN 45	+/-300.00%	0.00%	45
	6.4.3	MOTORISED POT RAMP / MP Up time PIN 46	0.1 - 600.0 s	10.0 secs	46
	6.4.3	MOTORISED POT RAMP / MP Down time PIN 47	0.1 - 600.0 s	10.0 secs	47
	6.4.4	MOTORISED POT RAMP / MP Up command PIN 48	0 - 1	Disabled	48
	6.4.4	MOTORISED POT RAMP / MP Down command PIN 49	0 - 1	Disabled	49
	6.4.5	MOTORISED POT RAMP / MP Maximum clamp PIN 50	+/-300.00%	100.00%	50
	6.4.5	MOTORISED POT RAMP / MP Minimum clamp PIN 51	+/-300.00%	-100.00%	51
	6.4.6	MOTORISED POT RAMP / MP preset enable PIN 52	0 - 1	Disabled	52
	6.4.7	MOTORISED POT RAMP / MP Preset value PIN 53	+/-300.00%	0.00%	53
	6.4.8	MOTORISED POT RAMP / MP memory boot up mode PIN 54	0 - 1	Disabled	54
				0	55

R	6.5.2	STOP MODE RAMP / Stop ramp time PIN 56	0.1 – 600.0 s	10.0 secs	56
	6.5.3	STOP MODE RAMP / Stop time limit PIN 57	0.0 – 600.0 s	60.0 secs	57
	6.5.4	STOP MODE RAMP / Live delay mode PIN 58	0 - 1	Disabled	58
R	6.5.5	STOP MODE RAMP / Drop-out speed PIN 59	0 – 100.00%	2.00%	59
	6.5.6	STOP MODE RAMP / Drop-out delay PIN 60	0.1 – 600.0 s	1.0 secs	60
				0	61
R	6.6.2	SPEED REF SUMMER / Internal speed reference 1 PIN 62	+/-105.00%	0.00%	62
R	6.6.3	SPEED REF SUMMER / Auxiliary speed reference 2 PIN 63	+/-105.00%	0.00%	63
R	6.6.4	SPEED REF SUMMER / Speed reference 3 monitor PIN 64	+/-105.00%	0.00%	64
R	6.6.5	SPEED REF SUMMER / Ramped speed reference 4 PIN 65	+/-105.00%	0.00%	65
R	6.6.6	SPEED REF SUMMER / Speed/ Current reference 3 sign PIN 66	0 - 1	Non-invert	66
R	6.6.7	SPEED REF SUMMER / Speed/ Current reference 3 ratio PIN 67	+/-3.0000	1.0000	67
				0	68
R	6.7.2	SPEED CONTROL / Max+ speed reference PIN 69	0 - 105.00%	105.00%	69
R	6.7.3	SPEED CONTROL / Max- speed reference PIN 70	0 - -105.00%	-105.00%	70
R	6.7.4	SPEED CONTROL / Speed proportional gain PIN 71	0 – 200.00	15.00	71
R	6.7.5	SPEED CONTROL / Speed integral time constant PIN 72	.001-30.000s	1.000 s	72
	6.7.6	SPEED CONTROL / Speed integral reset PIN 73	0 - 1	Disabled	73
	6.7.7.1	SPEED PI ADAPTION / Low break point PIN 74	0 – 100.00%	1.00%	74
	6.7.7.2	SPEED PI ADAPTION / High break point PIN 75	0 – 100.00%	2.00%	75
	6.7.7.3	SPEED PI ADAPTION / Low point proportional gain PIN 76	0 - 200	5.00	76
	6.7.7.4	SPEED PI ADAPTION / Low integral time constant PIN 77	.001-30.000s	1.000 secs	77
	6.7.7.5	SPEED PI ADAPTION / Integral % during ramp PIN 78	0 – 100.00%	100.00%	78
	6.7.7.6	SPEED PI ADAPTION / Adapt input enable PIN 79	0 - 1	Enabled	79
				0	80
R	6.8.2	CURRENT CONTROL / Current clamp scaler PIN 81	0 - 150.00%	150.00%	81
S	6.8.3.1	CURRENT OVERLOAD / Overload % target value PIN 82	0 - 105.00%	105.00%	82
S	6.8.3.2	CURRENT OVERLOAD / Overload ramp time PIN 83	0 – 20.0 s	20.0 secs	83
	6.8.4.1	I DYNAMIC PROFILE / I Profile enable PIN 84	0 - 1	Disabled	84
	6.8.4.2	I DYNAMIC PROFILE / Speed break point at high current PIN 85	0 - 105.00%	75.00%	85
	6.8.4.3	I DYNAMIC PROFILE / Speed break point at low current PIN 86	0 - 105.00%	100.00%	86
	6.8.4.4	I DYNAMIC PROFILE / Current limit at low current PIN 87	0 - 150.00%	100.00%	87
	6.8.5	CURRENT CONTROL / Dual current clamps enable PIN 88	0 - 1	Disabled	88
	6.8.6	CURRENT CONTROL / Upper current clamp PIN 89	+/-100.00%	100.00%	89
	6.8.7	CURRENT CONTROL / Lower current clamp PIN 90	+/-100.00%	-100.00%	90
	6.8.8	CURRENT CONTROL / Extra current reference PIN 91	+/-300.00%	0.00%	91
S	6.8.9	CURRENT CONTROL / Autotune enable PIN 92	0 - 1	Disabled	92
R	6.8.10	CURRENT CONTROL / Current amp proportional gain PIN 93	0 – 200.00	30.00	93
R	6.8.11	CURRENT CONTROL / Current amp integral gain PIN 94	0 – 200.00	3.00	94
R	6.8.12	CURRENT CONTROL / Discontinuous current point PIN 95	0 – 200.00%	13.00%	95
R/S	6.8.13	CURRENT CONTROL / 4-quadrant mode enable PIN 96	0 - 1	Enabled	96
	6.8.14	CURRENT CONTROL / Speed bypass current demand enable PIN 97	0 - 1	Disabled	97
				0	98
R/S	6.9.2	FIELD CONTROL / Field enable PIN 99	0 -1	Enabled	99
R/P	6.9.3	FIELD CONTROL / Voltage output % PIN 100	0 - 100.00%	90.00%	100
	6.9.4	FIELD CONTROL / Field proportional gain PIN 101	0 - 1000	10	101
	6.9.5	FIELD CONTROL / Field integral gain PIN 102	0 - 1000	100	102
S	6.9.6.1	WEAKENING MENU / Field weakening enable PIN 103	0 - 1	Disabled	103
	6.9.6.2	WEAKENING MENU / Field weakening proportional gain PIN 104	0 - 1000	50	104
	6.9.6.3	WEAKENING MENU / Field weakening integral TC PIN 105	0 – 20000 ms	4000 ms	105
	6.9.6.4	WEAKENING MENU / Field weakening derivative TC PIN 106	10 – 5000 ms	200 ms	106
	6.9.6.5	WEAKENING MENU / Field weakening feedback deriv TC PIN 107	10 – 5000 ms	100 ms	107
	6.9.6.6	WEAKENING MENU / Field weakening feedback int TC PIN 108	10 – 5000 ms	100 ms	108
	6.9.6.7	WEAKENING MENU / Spillover armature voltage % PIN 109	0 – 100.00%	100.00%	109
	6.9.6.8	WEAKENING MENU / Minimum field current % PIN 110	0 – 100.00%	10.00%	110
	6.9.7	FIELD CONTROL / Standby field enable PIN 111	0 - 1	Disabled	111
	6.9.8	FIELD CONTROL / Standby field value PIN 112	0 – 100.00%	25.00%	112
	6.9.9	FIELD CONTROL / Field quench delay PIN 113	0 – 600.0 s	10.0 secs	113
	6.9.10	FIELD CONTROL / Field reference PIN 114	0 – 100.00%	100.00%	114
R	6.10.2	ZERO INTERLOCKS / Standstill enable PIN 115	0 - 1	Disabled	115
	6.10.3	ZERO INTERLOCKS / Zero reference start enable PIN 116	0 - 1	Disabled	116
R	6.10.4	ZERO INTERLOCKS / Zero interlocks speed level PIN 117	0 – 100.00%	1.00%	117
R	6.10.5	ZERO INTERLOCKS / Zero interlocks current level PIN 118	0 – 100.00%	1.50%	118
	6.10.6	ZERO INTERLOCKS / At zero reference flag PIN 119	0 - 1	Low	119
	6.10.7	ZERO INTERLOCKS / At zero speed flag PIN 120	0 - 1	Low	120
	6.10.8	ZERO INTERLOCKS / At standstill flag PIN 121	0 - 1	Low	121
	6.10.9.2	SPINDLE ORIENTATE / Zero speed lock PIN 122	0 – 100.00	0.00	122

## 15.1.2 Diagnostics and alarms 123 - 183

Property	Paragraph	Menu / Description	Range	Default	PIN
R	7.1.1	SPEED LOOP MONITOR / Total speed reference monitor PIN 123	+/-300.00%	0.00%	123
	7.1.2	SPEED LOOP MONITOR / Speed demand monitor PIN 124	+/-300.00%	0.00%	124
	7.1.3	SPEED LOOP MONITOR / Speed error monitor PIN 125	+/-300.00%	0.00%	125
R	7.1.4	SPEED LOOP MONITOR / Armature volts monitor PIN 126	+/-1250.0V	0.0 V	126
	7.1.5	SPEED LOOP MONITOR / Armature volts % monitor PIN 127	+/-300.00%	0.00%	127
	7.1.6	SPEED LOOP MONITOR / Back emf % monitor PIN 128	+/-300.00%	0.00%	128
R	7.1.7	SPEED LOOP MONITOR / Tachogenerator volts monitor PIN 129	+/-220.00 V	0.00 V	129
R	7.1.8	SPEED LOOP MONITOR / Motor RPM monitor PIN 130	+/- 7500 rpm	0 rpm	130
R	7.1.10	SPEED LOOP MONITOR / Speed feedback % monitor PIN 131	+/-300.00%	0.00%	131
R	7.1.9	SPEED LOOP MONITOR / Encoder RPM monitor PIN 132	+/- 7500 rpm	0 rpm	132
R	7.2.1	ARM I LOOP MONITOR / Arm current demand monitor PIN 133	+/- 150.00%	0.00%	133
R	7.2.2	ARM I LOOP MONITOR / Arm current % monitor PIN 134	+/- 150.00%	0.00%	134
R	7.2.3	ARM I LOOP MONITOR / Arm current amps monitor PIN 135	+/-3000.0 A	0.00 Amps	135
	7.2.4	ARM I LOOP MONITOR / Upper current limit monitor PIN 136	+/-150.00%	0.00%	136
	7.2.5	ARM I LOOP MONITOR / Lower current limit monitor PIN 137	+/-150.00%	0.00%	137
R	7.2.6	ARM I LOOP MONITOR / Actual upper limit monitor PIN 138	+/-150.00%	0.00%	138
R	7.2.6	ARM I LOOP MONITOR / Actual lower limit monitor PIN 139	+/-150.00%	0.00%	139
	7.2.7	ARM I LOOP MONITOR / Overload limit monitor PIN 140	0 -150.00%	0.00%	140
	7.2.8	ARM I LOOP MONITOR / At current limit flag PIN 141	0 - 1	Low	141
				0	142
R	7.3.1	FIELD MONITOR / Field demand monitor PIN 143	0 -100.00%	0.00%	143
R	7.3.2	FIELD MONITOR / Field current % monitor PIN 144	0 -125.00%	0.00%	144
R	7.3.3	FIELD MONITOR / Field amps monitor PIN 145	0 - 50.00 A	0.00 Amps	145
	7.3.4	FIELD MONITOR / Field firing angle monitor PIN 146	0 - 155 Deg	0 Deg	146
	7.3.5	FIELD MONITOR / Field active monitor PIN 147	0 - 1	disabled	147
				0	148
				0	149
R	7.4.1	ANALOG IO MONITOR / UIP2 analogue input monitor PIN 150	+/- 30.730	0.000 V	150
R	7.4.1	ANALOG IO MONITOR / UIP3 analogue input monitor PIN 151	+/- 30.730	0.000 V	151
R	7.4.1	ANALOG IO MONITOR / UIP4 analogue input monitor PIN 152	+/- 30.730	0.000 V	152
	7.4.1	ANALOG IO MONITOR / UIP5 analogue input monitor PIN 153	+/- 30.730	0.000 V	153
	7.4.1	ANALOG IO MONITOR / UIP6 analogue input monitor PIN 154	+/- 30.730	0.000 V	154
	7.4.1	ANALOG IO MONITOR / UIP7 analogue input monitor PIN 155	+/- 30.730	0.000 V	155
	7.4.1	ANALOG IO MONITOR / UIP8 analogue input monitor PIN 156	+/- 30.730	0.000 V	156
	7.4.1	ANALOG IO MONITOR / UIP9 analogue input monitor PIN 157	+/- 30.730	0.000 V	157
				0	158
	7.4.2	ANALOG IO MONITOR / AOP1 analogue output monitor PIN 159	+/-11.300 V	0.000 V	159
	7.4.2	ANALOG IO MONITOR / AOP2 analogue output monitor PIN 160	+/-11.300 V	0.000 V	160
	7.4.2	ANALOG IO MONITOR / AOP3 analogue output monitor PIN 161	+/-11.300 V	0.000 V	161
R	7.5.1	DIGITAL IO MONITOR / UIP2 to 9 digital input monitor PIN 162	0/1 times 8	00000000	162
R	7.5.2	DIGITAL IO MONITOR / DIP1-4 and DIO1-4 dig IP monitor PIN 163	0/1 times 8	00000000	163
R	7.5.3	DIGITAL IO MONITOR / DOP1-3 + Control IPs dig OP mon PIN 164	0/1 times 8	00000000	164
	7.5.4	DIGITAL IO MONITOR / + Armature bridge flag PIN 165	0 - 1	Low	165
R	7.5.5	DIGITAL IO MONITOR / Drive start flag PIN 166	0 - 1	Low	166
R	7.5.6	DIGITAL IO MONITOR / Drive run flag PIN 167	0 - 1	Low	167
R	7.5.7	DIGITAL IO MONITOR / Internal running mode monitor PIN 168	1 of 8 modes	Stop	168
R	7.7	DIAGNOSTICS / EL1/2/3 RMS monitor PIN 169	0- 1000.0 V	0.0 V	169
R	7.8	DIAGNOSTICS / DC KILOWATTS monitor PIN 169	+/-3000.0Kw	0.0	170
R	8.1.1	MOTOR DRIVE ALARMS / Speed fb mismatch trip enable PIN 171	0 - 1	Enabled	171
	8.1.2	MOTOR DRIVE ALARMS / Speed fb mismatch tolerance PIN 172	0 -100.00%	50.00%	172
R	8.1.3	MOTOR DRIVE ALARMS / Field loss trip disable PIN 173	0 - 1	Enabled	173
	8.1.4	MOTOR DRIVE ALARMS / Dig OP short circuit trip enable PIN 174	0 - 1	Disabled	174
	8.1.5	MOTOR DRIVE ALARMS / Missing pulse trip enable PIN 175	0 - 1	Enabled	175
	8.1.6	MOTOR DRIVE ALARMS / Reference exchange trip enable PIN 176	0 - 1	Disabled	176
	8.1.7	MOTOR DRIVE ALARMS / Overspeed delay time PIN 177	0.1 - 600.0 s	5.00 secs	177
R	8.1.8.1	STALL TRIP MENU / Stall trip enable PIN 178	0 - 1	Enabled	178
R	8.1.8.2	STALL TRIP MENU / Stall current level PIN 179	0 -150.00%	95.00%	179
R	8.1.8.3	STALL TRIP MENU / Stall delay time PIN 180	0.1 - 600.0 s	10.0 secs	180
	8.1.9	MOTOR DRIVE ALARMS / Active trip monitor PIN 181	0000 - FFFF	0000	181
	8.1.9	MOTOR DRIVE ALARMS / Stored trip monitor PIN 182	0000 - FFFF	0	182
	8.1.10	MOTOR DRIVE ALARMS / External trip reset enable PIN 183	0 - 1	Enabled	183

## 15.1.3 Serial links 187 - 249

Property	Paragraph	Menu / Description	Range	Default	PIN
				0	184
				0	185
				0	186
R	10.1.2	RS232 PORT1 / Port1 Baud rate PIN 187	300 - 57600	9600	187
S	10.1.3	PORT1 FUNCTION / Port1 function mode PIN 188	1 of 4 modes	Param exch	188
	10.3.1	PORT1 REF EXCHANGE / Ref exchange slave ratio PIN 189	+/-3.0000	1.0000	189
	10.3.2	PORT1 REF EXCHANGE / Ref exchange slave sign PIN 190	0 - 1	Non-invert	190
	10.3.3	PORT1 REF EXCHANGE / Ref exchange slave monitor PIN 191	+/-300.00%	0.00%	191
	10.3.4	PORT1 REF EXCHANGE / Ref exchange master monitor PIN 192	+/-300.00%	0.00%	192
	10.2.5	PORT 1 COMMS LINK / Port 1 group ID PIN 193	0 - 7	0	193
	10.2.5	PORT 1 COMMS LINK / Port 1 unit ID PIN 194	0 - 15	0	194
	10.2.5	PORT 1 COMMS LINK / Port 1 error code PIN 195	1 - 8	1	195
S	10.2.5	PORT 1 COMMS LINK / Port 1 DOP3 RTS mode PIN 196	0 - 1	Disabled	196
					197
					198
	Serial Comms	FIELDBUS CONFIG / Fieldbus data control PIN 199	00 - 11	00	199
		FBUS ON-LINE MON (Hidden pin)	0 - 1	Low	200
					201
					202
		RESERVED			203 to 239
	6.10.9.3	SPINDLE ORIENTATE / Marker enable PIN 240	0 - 1	Disabled	240
	6.10.9.4	SPINDLE ORIENTATE / Marker offset PIN 241	+/-15,000	0	241
	6.10.9.5	SPINDLE ORIENTATE / Position reference PIN 242	+/-30,000	0	242
	6.10.9.6	SPINDLE ORIENTATE / Marker frequency monitor PIN 243	20-655.37 Hz	0 Hz	243
	6.10.9.7	SPINDLE ORIENTATE / In position flag PIN 244	0 - 1	Low	244

## 15.1.4 Configuration 251 - 400

Property	Paragraph	Menu / Description	Range	Default	PIN
	13.4.1	ANALOG OUTPUTS / Iarm o/p rectify enable PIN 250	0 - 1	Disabled	250
	13.4.2.1	AOP1 (T10) SETUP / AOP1 Dividing factor PIN 251	+/- 3.0000	1.0000	251
	13.4.2.2	AOP1 (T10) SETUP / AOP1 Offset PIN 252	+/-100.00%	0.00%	252
	13.4.2.3	AOP1 (T10) SETUP / AOP1 Rectifier mode enable PIN 253	0 - 1	Disabled	253
	13.4.2.1	AOP2 (T11) SETUP / AOP2 Dividing factor PIN 254	+/- 3.0000	1.0000	254
	13.4.2.2	AOP2 (T11) SETUP / AOP2 Offset PIN 255	+/-100.00%	0.00%	255
	13.4.2.3	AOP2 (T11) SETUP / AOP2 Rectifier mode enable PIN 256	0 - 1	Disabled	256
	13.4.2.1	AOP3 (T12) SETUP / AOP3 Dividing factor PIN 257	+/- 3.0000	1.0000	257
	13.4.2.2	AOP3 (T12) SETUP / AOP3 Offset PIN 258	+/-100.00%	0.00%	258
	13.4.2.3	AOP3 (T13) SETUP / AOP3 Rectifier mode enable PIN 259	0 - 1	Disabled	259
	13.4.3	ANALOG OUTPUTS / Scope output select on AOP3 PIN 260	0 - 1	Disabled	260
	13.7.1.1	DOP1 (T22) SETUP / DOP1 Output value rectifier enable PIN 261	0 - 1	Enabled	261
	13.7.1.2	DOP1 (T22) SETUP / DOP1 OP comparator threshold . PIN 262	+/-300.00%	0.00%	262
	13.7.1.3	DOP1 (T22) SETUP / DOP1 Output inversion mode PIN 263	0 - 1	Non invert	263
	13.7.1.1	DOP2 (T23) SETUP / DOP2 Output value rectifier enable PIN 264	0 - 1	Enabled	264
	13.7.1.2	DOP2 (T23) SETUP / DOP2 OP comparator threshold PIN 265	+/-300.00%	0.00%	265
	13.7.1.3	DOP2 (T23) SETUP / DOP2 Output inversion mode PIN 266	0 - 1	Non invert	266
	13.7.1.1	DOP3 (T24) SETUP / DOP3 Output value rectifier enable PIN 267	0 - 1	Enabled	267
	13.7.1.2	DOP3 (T24) SETUP / DOP3 OP comparator threshold PIN 268	+/-300.00%	0.00%	268
	13.7.1.3	DOP3 (T24) SETUP / DOP3 Output inversion mode PIN 269	0 - 1	Non invert	269
				0	270
S	13.6.1.1	DIO1 (T18) SETUP / DIO1 Output mode enable PIN 271	0 - 1	Disabled	271
	13.6.1.2	DIO1 (T18) SETUP / DIO1 Output value rectify enable PIN 272	0 - 1	Enabled	272
	13.6.1.3	DIO1 (T18) SETUP / DIO1 OP comparator threshold PIN 273	+/-300.00%	0.00%	273
	13.6.1.4	DIO1 (T18) SETUP / DIO1 Output inversion mode PIN 274	0 - 1	Non invert	274
	13.6.1.7	DIO1 (T18) SETUP / DIO1 Input high value PIN 275	+/-300.00%	0.01%	275
	13.6.1.8	DIO1 (T18) SETUP / DIO1 Input low value PIN 276	+/-300.00%	0.00%	276
S	13.6.1.1	DIO2 (T19) SETUP / DIO2 Output mode enable PIN 277	0 - 1	Disabled	277
	13.6.1.2	DIO2 (T19) SETUP / DIO2 Output value rectify enable PIN 278	0 - 1	Enabled	278
	13.6.1.3	DIO2 (T19) SETUP / DIO2 OP comparator threshold PIN 279	+/-300.00%	0.00%	279
	13.6.1.4	DIO2 (T19) SETUP / DIO2 Output inversion mode PIN 280	0 - 1	Non invert	280
	13.6.1.7	DIO2 (T19) SETUP / DIO2 Input high value PIN 281	+/-300.00%	0.01%	281
	13.6.1.8	DIO2 (T19) SETUP / DIO2 Input low value PIN 282	+/-300.00%	0.00%	282

S	13.6.1.1	DIO3 (T20) SETUP / DIO3 Output mode enable PIN 283	0 - 1	Disabled	283
	13.6.1.2	DIO3 (T20) SETUP / DIO3 Output value rectify enable PIN 284	0 - 1	Enabled	284
	13.6.1.3	DIO3 (T20) SETUP / DIO3 OP comparator threshold PIN 285	+/-300.00%	0.00%	285
	13.6.1.4	DIO3 (T20) SETUP / DIO3 Output inversion mode PIN 286	0 - 1	Non invert	286
	13.6.1.7	DIO3 (T20) SETUP / DIO3 Input high value PIN 287	+/-300.00%	0.01%	287
	13.6.1.8	DIO3 (T20) SETUP / DIO3 Input low value PIN 288	+/-300.00%	0.00%	288
S	13.6.1.1	DIO4 (T21) SETUP / DIO4 Output mode enable PIN 289	0 - 1	Disabled	289
	13.6.1.2	DIO4 (T21) SETUP / DIO4 Output value rectify enable PIN 290	0 - 1	Enabled	290
	13.6.1.3	DIO4 (T21) SETUP / DIO4 OP comparator threshold PIN 291	+/-300.00%	0.00%	291
	13.6.1.4	DIO4 (T21) SETUP / DIO4 Output inversion mode PIN 292	0 - 1	Non invert	292
	13.6.1.7	DIO4 (T21) SETUP / DIO4 Input high value PIN 293	+/-300.00%	0.01%	293
	13.6.1.8	DIO4 (T21) SETUP / DIO4 Input low value PIN 294	+/-300.00%	0.00%	294
				0	295
	13.8.2	STAGING POSTS / Digital post 1 PIN 296	0 - 1	Low	296
	13.8.2	STAGING POSTS / Digital post 2 PIN 297	0 - 1	Low	297
	13.8.2	STAGING POSTS / Digital post 3 PIN 298	0 - 1	Low	298
	13.8.2	STAGING POSTS / Digital post 4 PIN 299	0 - 1	Low	299
	13.8.2	STAGING POSTS / Analog post 1 PIN 300	+/-300.00%	0.00%	300
	13.8.2	STAGING POSTS / Analog post 2 PIN 301	+/-300.00%	0.00%	301
	13.8.2	STAGING POSTS / Analog post 3 PIN 302	+/-300.00%	0.00%	302
	13.8.2	STAGING POSTS / Analog post 4 PIN 303	+/-300.00%	0.00%	303
				0	304
	13.9.1	SOFTWARE TERMINALS / Anded run PIN 305	0 - 1	High	305
	13.9.2	SOFTWARE TERMINALS / Anded jog PIN 306	0 - 1	High	306
	13.9.3	SOFTWARE TERMINALS / Anded start PIN 307	0 - 1	High	307
	13.9.4	SOFTWARE TERMINALS / Internal run PIN 308	0 - 1	Low	308
				0	309
	13.5.2.1	DIP1 (T14) SETUP / DIP1 Input high value PIN 310	+/-300.00%	0.01%	310
	13.5.2.2	DIP1 (T14) SETUP / DIP1 Input low value PIN 311	+/-300.00%	0.00%	311
	13.5.2.1	DIP2 (T15) SETUP / DIP2 Input high value PIN 312	+/-300.00%	0.01%	312
	13.5.2.2	DIP2 (T15) SETUP / DIP2 Input low value PIN 313	+/-300.00%	0.00%	313
	13.5.2.1	DIP3 (T16) SETUP / DIP3 Input high value PIN 314	+/-300.00%	0.01%	314
	13.5.2.2	DIP3 (T16) SETUP / DIP3 Input low value PIN 315	+/-300.00%	0.00%	315
	13.5.2.1	DIP4 (T17) SETUP / DIP4 Input high value PIN 316	+/-300.00%	0.01%	316
	13.5.2.2	DIP4 (T17) SETUP / DIP4 Input low value PIN 317	+/-300.00%	0.00%	317
	13.5.3.1	RUN INPUT SETUP / RUN input HI value PIN 318	+/-300.00%	0.01%	318
	13.5.3.2	RUN INPUT SETUP / RUN input LO value PIN 319	+/-300.00%	0.00%	319
	13.3.1.1	UIP2 (T2) SETUP / UIP2 Input range PIN 320	1 of 4 ranges	10V range	320
	13.3.1.2	UIP2 (T2) SETUP / UIP2 Input offset PIN 321	+/-100.00%	0.00%	321
	13.3.1.3	UIP2 (T2) SETUP / UIP2 Linear scaling factor PIN 322	+/-3.0000	1.0000	322
	13.3.1.4	UIP2 (T2) SETUP / UIP2 Max clamp level PIN 323	+/-300.00%	100.00%	323
	13.3.1.5	UIP2 (T2) SETUP / UIP2 Min clamp level PIN 324	+/-300.00%	-100.00%	324
	13.3.1.9	UIP2 (T2) SETUP / UIP2 Digital IP, high value for output 1 PIN 325	+/-300.00%	0.01%	325
	13.3.1.10	UIP2 (T2) SETUP / UIP2 Digital IP, low value for output 1 PIN 326	+/-300.00%	0.00%	326
	13.3.1.11	UIP2 (T2) SETUP / UIP2 Digital IP, high value for output 2 PIN 327	+/-300.00%	0.01%	327
	13.3.1.12	UIP2 (T2) SETUP / UIP2 Digital IP, low value for output 2 PIN 328	+/-300.00%	0.00%	328
	13.3.1.13	UIP2 (T2) SETUP / UIP2 Threshold PIN 329	+/-30.000 V	6.000V	329
	13.3.1.1	UIP3 (T3) SETUP / UIP3 Input range PIN 330	1 of 4 ranges	10V range)	330
	13.3.1.2	UIP3 (T3) SETUP / UIP3 Input offset PIN 331	+/-100.00%	0.00%	331
	13.3.1.3	UIP3 (T3) SETUP / UIP3 Linear scaling factor PIN 332	+/-3.0000	1.0000	332
	13.3.1.4	UIP3 (T3) SETUP / UIP3 Max clamp level PIN 333	+/-300.00%	100.00%	333
	13.3.1.5	UIP3 (T3) SETUP / UIP3 Min clamp level PIN 334	+/-300.00%	-100.00%	334
	13.3.1.9	UIP3 (T3) SETUP / UIP3 Digital IP, high value for output 1 PIN 335	+/-300.00%	0.01%	335
	13.3.1.10	UIP3 (T3) SETUP / UIP3 Digital IP, low value for output 1 PIN 336	+/-300.00%	0.00%	336
	13.3.1.11	UIP3 (T3) SETUP / UIP3 Digital IP, high value for output 2 PIN 337	+/-300.00%	0.01%	337
	13.3.1.12	UIP3 (T3) SETUP / UIP3 Digital IP, low value for output 2 PIN 338	+/-300.00%	0.00%	338
	13.3.1.13	UIP3 (T3) SETUP / UIP3 Threshold PIN 339	+/-30.000 V	6.000V	339
	13.3.1.1	UIP4 (T4) SETUP / UIP4 Input range PIN 340	1 of 4 ranges	10V range	340
	13.3.1.2	UIP4 (T4) SETUP / UIP4 Input offset PIN 341	+/-100.00%	0.00%	341
	13.3.1.3	UIP4 (T4) SETUP / UIP4 Linear scaling factor PIN 342	+/-3.0000	1.0000	342
	13.3.1.4	UIP4 (T4) SETUP / UIP4 Max clamp level PIN 343	+/-300.00%	100.00%	343
	13.3.1.5	UIP4 (T4) SETUP / UIP4 Min clamp level PIN 344	+/-300.00%	-100.00%	344
	13.3.1.9	UIP4 (T4) SETUP / UIP4 Digital IP, high value for output 1 PIN 345	+/-300.00%	0.01%	345
	13.3.1.10	UIP4 (T4) SETUP / UIP4 Digital IP, low value for output 1 PIN 346	+/-300.00%	0.00%	346
	13.3.1.11	UIP4 (T4) SETUP / UIP4 Digital IP, high value for output 2 PIN 347	+/-300.00%	0.01%	347
	13.3.1.12	UIP4 (T4) SETUP / UIP4 Digital IP, low value for output 2 PIN 348	+/-300.00%	0.00%	348
	13.3.1.13	UIP4 (T4) SETUP / UIP4 Threshold PIN 349	+/-30.000 V	6.000V	349

	13.3.1.1	UIP5 (T5) SETUP / UIP5 Input range PIN 350	1 of 4 ranges	10V range	350
	13.3.1.2	UIP5 (T5) SETUP / UIP5 Input offset PIN 351	+/-100.00%	0.00%	351
	13.3.1.3	UIP5 (T5) SETUP / UIP5 Linear scaling factor PIN 352	+/-3.0000	1.0000	352
	13.3.1.4	UIP5 (T5) SETUP / UIP5 Max clamp level PIN 353	+/-300.00%	100.00%	353
	13.3.1.5	UIP5 (T5) SETUP / UIP5 Min clamp level PIN 354	+/-300.00%	-100.00%	354
	13.3.1.9	UIP5 (T5) SETUP / UIP5 Digital IP, high value for output 1 PIN 355	+/-300.00%	0.01%	355
	13.3.1.10	UIP5 (T5) SETUP / UIP5 Digital IP, low value for output 1 PIN 356	+/-300.00%	0.00%	356
	13.3.1.11	UIP5 (T5) SETUP / UIP5 Digital IP, high value for output 2 PIN 357	+/-300.00%	0.01%	357
	13.3.1.12	UIP5 (T5) SETUP / UIP5 Digital IP, low value for output 2 PIN 358	+/-300.00%	0.00%	358
	13.3.1.13	UIP5 (T5) SETUP / UIP5 Threshold PIN 359	+/-30.000 V	6.000V	359
	13.3.1.1	UIP6 (T6) SETUP / UIP6 Input range PIN 360	1 of 4 ranges	10V range	360
	13.3.1.2	UIP6 (T6) SETUP / UIP6 Input offset PIN 361	+/-100.00%	0.00%	361
	13.3.1.3	UIP6 (T6) SETUP / UIP6 Linear scaling factor PIN 362	+/-3.0000	1.0000	362
	13.3.1.4	UIP6 (T6) SETUP / UIP6 Max clamp level PIN 363	+/-300.00%	100.00%	363
	13.3.1.5	UIP6 (T6) SETUP / UIP6 Min clamp level PIN 364	+/-300.00%	-100.00%	364
	13.3.1.9	UIP6 (T6) SETUP / UIP6 Digital IP, high value for output 1 PIN 365	+/-300.00%	0.01%	365
	13.3.1.10	UIP6 (T6) SETUP / UIP6 Digital IP, low value for output 1 PIN 366	+/-300.00%	0.00%	366
	13.3.1.11	UIP6 (T6) SETUP / UIP6 Digital IP, high value for output 2 PIN 367	+/-300.00%	0.01%	367
	13.3.1.12	UIP6 (T6) SETUP / UIP6 Digital IP, low value for output 2 PIN 368	+/-300.00%	0.00%	368
	13.3.1.13	UIP6 (T6) SETUP / UIP6 Threshold PIN 369	+/-30.000 V	6.000V	369
	13.3.1.1	UIP7 (T7) SETUP / UIP7 Input range PIN 370	1 of 4 ranges	10V range	370
	13.3.1.2	UIP7 (T7) SETUP / UIP7 Input offset PIN 371	+/-100.00%	0.00%	371
	13.3.1.3	UIP7 (T7) SETUP / UIP7 Linear scaling factor PIN 372	+/-3.0000	1.0000	372
	13.3.1.4	UIP7 (T7) SETUP / UIP7 Max clamp level PIN 373	+/-300.00%	100.00%	373
	13.3.1.5	UIP7 (T7) SETUP / UIP7 Min clamp level PIN 374	+/-300.00%	-100.00%	374
	13.3.1.9	UIP7 (T7) SETUP / UIP7 Digital IP, high value for output 1 PIN 375	+/-300.00%	0.01%	375
	13.3.1.10	UIP7 (T7) SETUP / UIP7 Digital IP, low value for output 1 PIN 376	+/-300.00%	0.00%	376
	13.3.1.11	UIP7 (T7) SETUP / UIP7 Digital IP, high value for output 2 PIN 377	+/-300.00%	0.01%	377
	13.3.1.12	UIP7 (T7) SETUP / UIP7 Digital IP, low value for output 2 PIN 378	+/-300.00%	0.00%	378
	13.3.1.13	UIP7 (T7) SETUP / UIP7 Threshold PIN 379	+/-30.000 V	6.000V	379
	13.3.1.1	UIP8 (T8) SETUP / UIP8 Input range PIN 380	1 of 4 ranges	10V range	380
	13.3.1.2	UIP8 (T8) SETUP / UIP8 Input offset PIN 381	+/-100.00%	0.00%	381
	13.3.1.3	UIP8 (T8) SETUP / UIP8 Linear scaling factor PIN 382	+/-3.0000	1.0000	382
	13.3.1.4	UIP8 (T8) SETUP / UIP8 Max clamp level PIN 383	+/-300.00%	100.00%	383
	13.3.1.5	UIP8 (T8) SETUP / UIP8 Min clamp level PIN 384	+/-300.00%	-100.00%	384
	13.3.1.9	UIP8 (T8) SETUP / UIP8 Digital IP, high value for output 1 PIN 385	+/-300.00%	0.01%	385
	13.3.1.10	UIP8 (T8) SETUP / UIP8 Digital IP, low value for output 1 PIN 386	+/-300.00%	0.00%	386
	13.3.1.11	UIP8 (T8) SETUP / UIP8 Digital IP, high value for output 2 PIN 387	+/-300.00%	0.01%	387
	13.3.1.12	UIP8 (T8) SETUP / UIP8 Digital IP, low value for output 2 PIN 388	+/-300.00%	0.00%	388
	13.3.1.13	UIP8 (T8) SETUP / UIP8 Threshold PIN 389	+/-30.000 V	6.000V	389
	13.3.1.1	UIP9 (T9) SETUP / UIP9 Input range PIN 390	1 of 4 ranges	10V range	390
	13.3.1.2	UIP9 (T9) SETUP / UIP9 Input offset PIN 391	+/-100.00%	0.00%	391
	13.3.1.3	UIP9 (T9) SETUP / UIP9 Linear scaling factor PIN 392	+/-3.0000	1.0000	392
	13.3.1.4	UIP9 (T9) SETUP / UIP9 Max clamp level PIN 393	+/-300.00%	100.00%	393
	13.3.1.5	UIP9 (T9) SETUP / UIP9 Min clamp level PIN 394	+/-300.00%	-100.00%	394
	13.3.1.9	UIP9 (T9) SETUP / UIP9 Digital IP, high value for output 1 PIN 395	+/-300.00%	0.01%	395
	13.3.1.10	UIP9 (T9) SETUP / UIP9 Digital IP, low value for output 1 PIN 396	+/-300.00%	0.00%	396
	13.3.1.11	UIP9 (T9) SETUP / UIP9 Digital IP, high value for output 2 PIN 397	+/-300.00%	0.01%	397
	13.3.1.12	UIP9 (T9) SETUP / UIP9 Digital IP, low value for output 2 PIN 398	+/-300.00%	0.00%	398
	13.3.1.13	UIP9 (T9) SETUP / UIP9 Threshold PIN 399	+/-30.000 V	6.000V	399
	13.2.5	Block disconnect PIN 400			400

## 15.1.5 Application blocks 401 - 680

Paragraph	Menu / Description	PIN
Application manual	SUMMER 1	401
Application manual	SUMMER 2	415
Application manual	PID 1	429
Application manual	PID 2	452
Application manual	PARAMETER PROFILER	475
Application manual	REEL DIAMETER CALC	483
Application manual	TAPER TENSION	494
Application manual	TORQUE COMPENSATOR	500
Application manual	PRESET SPEED	523
Application manual	MULTIFUNCTION 1 to 8	544



Application manual	LATCH	560
Application manual	FILTER 1	568
Application manual	FILTER 2	573
Application manual	BATCH COUNTER	578
Application manual	INTERVAL TIMER	583
Application manual	COMPARATOR 1 to 4	588
Application manual	C/O SWITCH 1 to 4	604
	Reserved for future blocks	616 to 677

	13.13.2	DRIVE PERSONALITY / Recipe page PIN 678	0 - 4	Normal Reset	677
S	13.13.3	DRIVE PERSONALITY / Max current response PIN 678	0 - 1	Disabled	678
	13.13	DRIVE PERSONALITY / ID ABCXRxxx MON PIN 679	Binary value	By model	679
P	13.13.4	DRIVE PERSONALITY / Iarm BURDEN OHMS PIN 680	1 to 327.67R	By model	680

### 15.1.6 Hidden pins 680 - 720

Paragraph	Menu / Description	Range	Default	PIN
5.1.2	Power.SAVED ONCE MON PIN 681	0 - 1	low	681
13.7.1.6	DOP1 O/P BIN VAL PIN 682	0 - 1	low	682
13.7.1.6	DOP2 O/P BIN VAL PIN 683	0 - 1	low	683
13.7.1.6	DOP3 O/P BIN VAL PIN 684	0 - 1	low	684
13.6.1.10	DIO1 O/P BIN VAL PIN 685	0 - 1	low	685
13.6.1.10	DIO2 O/P BIN VAL PIN 686	0 - 1	low	686
13.6.1.10	DIO3 O/P BIN VAL PIN 687	0 - 1	low	687
13.6.1.10	DIO4 O/P BIN VAL PIN 688	0 - 1	low	688
6.3	IN JOG FLAG / In Jog mode process flag PIN 689	0 - 1	low	689
Apps manual	WEB BREAK FLAG PIN 690	0 - 1	low	690
12.1.14	SUM1 CH2 SUBTOT / Summer1 Ch2 subtotal monitor PIN 691	+/-200.00%	0.00%	691
12.1.14	SUM1 CH1 SUBTOT / Summer1 Ch1 subtotal monitor PIN 692	+/-200.00%	0.00%	692
12.1.14	SUM2 CH2 SUBTOT / Summer2 Ch2 subtotal monitor PIN 693	+/-200.00%	0.00%	693
12.1.14	SUM2 CH1 SUBTOT / Summer2 Ch1 subtotal monitor PIN 694	+/-200.00%	0.00%	694
Apps manual	WEB SPEED RECT. PIN 695	0 - 105.00%	0.00%	695
Apps manual	REEL SPEED RECT. PIN 696	0 - 105.00%	0.00%	696
Apps manual	UNFILTERED DIAMETER 697	0 - 100.00%	0.00%	697
6.5.1.1	HEALTHY FLAG / Healthy flag output PIN 698	0 - 1	low	698
6.5.1.1	READY FLAG / Ready flag output PIN 699	0 - 1	low	699
8.1.8	STALL WARNING / Stall warning PIN 700	0 - 1	low	700
8.1.11.14	REF XC WARNING / Reference exchange error warning PIN 701	0 - 1	low	701
8.1.11.5	THERMISTOR WARN / Thermistor overtemp warning PIN 702	0 - 1	low	702
8.1.1	SPEED FBK WARN / Speed feedback mismatch warning PIN 703	0 - 1	low	703
8.1.9	I LOOP OFF WARN / Current loop off warning PIN 704	0 - 1	low	704
12.3	LP FILTER INPUT / Low pass filter input PIN 705		From GOTO	705
12.3	LP FILTER OUTPUT / Low pass filter output PIN 706		To GETFROM	706
6.8.9	AUTOTUNE MONITOR / Autotune in progress flag PIN 707	0 - 1	low	707
10.1.4.2	REMOTE PARAM RCV / Remote receive input PIN 708	0 - 1	low	708
6.1.10.3	MOTOR RPM % /Encoder RPM % mon PIN 709,(scaled by 12)MOT/ENC ratio)	+/-300.00%	0	709
12.14.1	POSITION COUNT / Running position counter PIN 710		0	710
12.14.1	POS CNT DIVIDER / Position count divider input PIN 711		1	711
8.1.11.5	USER ALARM INPUT PIN 712	0 - 1	low	712
6.7.1	SPEED LOOP PI OP / Speed loop PI output monitor PIN 700	+/-200.00%	0.00%	713
6.3	IN SLACK FLAG / In Slack mode process flag PIN 714	0 - 1	low	714
7.1.9	SPD FBK % UNF/ Unfiltered total speed feedback % mon PIN 715	+/-300.00%	0.00%	715
7.1.7	TACHO % UNF / Unfiltered analog tachometer % mon PIN 716	+/-300.00%	0.00%	716
7.1.8	MOTOR RPM UNF / Unfiltered motor RPM monitor PIN 717	+/-6000	0	717
7.2.1	CUR DEMAND UNF / Unfiltered current demand monitor PIN 718	+/-150.00%	0.00%	718
7.2.2	CUR FBK % UNF / Unfiltered current feedback % monitor PIN 719	+/-150.00%	0.00%	719
6.5.1.1	SYSTEM RESET / System reset pulse output PIN 720	0 - 1	low	720
			0	

## 15.2 Menu list

<b>PRESS RIGHT KEY FOR</b>	
Issue: 5.12	
<b>ENTRY MENU LEVEL 1</b>	
<b>CHANGE PARAMETERS 2</b>	
<b>RUN MODE RAMPS 3</b>	
.....21)RAMP OP MONITOR =	0.00 %
.....22)FORWARD UP TIME =	10.0 SECS
.....23)FORWARD DOWN TIME =	10.0 SECS
.....24)REVERSE UP TIME =	10.0 SECS
.....25)REVERSE DOWN TIME =	10.0 SECS
.....26)RAMP INPUT =	0.00 %
.....27)FORWARD MIN SPEED =	0.00 %
.....28)REVERSE MIN SPEED =	0.00 %
.....29)RAMP AUTO PRESET =	ENABLED
.....30)RAMP EXT PRESET =	DISABLED
.....31)RAMP PRESET VALUE =	0.00 %
.....32)RAMP S-PROFILE % =	2.50 %
.....33)RAMP HOLD =	DISABLED
.....34)RAMPING THRESHOLD =	0.50 %
.....35)RAMPING FLAG =	LOW
<b>JOG CRAWL SLACK 3</b>	
.....37)JOG SPEED 1 =	5.00 %
.....38)JOG SPEED 2 =	-5.00 %
.....39)SLACK SPEED 1 =	5.00 %
.....40)SLACK SPEED 2 =	-5.00 %
.....41)CRAWL SPEED =	10.00 %
.....42)JOG MODE SELECT =	LOW
.....43)JOG/SLACK RAMP =	1.0 SECS
<b>MOTORISED POT RAMP 3</b>	
.....45)MP OP MONITOR =	0.00 %
.....46)MP UP TIME =	10.0 SECS
.....47)MP DOWN TIME =	10.0 SECS
.....48)MP UP COMMAND =	DISABLED
.....49)MP DOWN COMMAND =	DISABLED
.....50)MP MAX CLAMP =	100.00 %
.....51)MP MIN CLAMP =	-100.00 %
.....52)MP PRESET =	DISABLED
.....53)MP PRESET VALUE =	0.00 %
.....54)MP MEMORY BOOT-UP =	DISABLED
<b>STOP MODE RAMP 3</b>	
.....56)STOP RAMP TIME =	10.0 SECS
.....57)STOP TIME LIMIT =	60.0 SECS
.....58)LIVE DELAY MODE =	DISABLED
.....59)DROP-OUT SPEED =	2.00 %
.....60)DROP-OUT DELAY =	1.0 SECS
<b>SPEED REF SUMMER 3</b>	
.....62)INT SPEED REF 1 =	0.00 %
.....63)SPEED REF 2 =	0.00 %
.....64)SPEED REF 3 MON =	0.00 %
.....65)RAMPED SPD REF 4 =	0.00 %
.....66)SPD/CUR REF3 SIGN =	NON-INVERT
.....67)SPD/CUR REF3 RATIO =	1.0000
<b>SPEED CONTROL 3</b>	
.....69)MAX POS SPEED REF =	105.00 %
.....70)MAX NEG SPEED REF =	-105.00 %
.....71)SPEED PROP GAIN =	15.00
.....72)SPEED INT T.C. =	1.000 SECS
.....73)SPEED INT RESET =	DISABLED
<b>SPEED PI ADAPTION 4</b>	
.....74)SPD ADPT LO BRPNT =	1.00 %
.....75)SPD ADPT HI BRPNT =	2.00 %
.....76)LO BRPNT PRP GAIN =	5.00
.....77)LO BRPNT INT T.C. =	1.000 SECS
.....78)INT % DURING RAMP =	100.00 %
.....79)SPD ADAPT ENABLE =	ENABLED
<b>CURRENT CONTROL 3</b>	
.....81)CUR CLAMP SCALAR =	150.00 %
<b>CURRENT OVERLOAD 4</b>	
.....82)O/LOAD % TARGET =	105.00 %
.....83)O/LOAD RAMP TIME =	20.0 SECS
<b>I DYNAMIC PROFILE 4</b>	
.....84)I PROFILE ENABLE =	DISABLED
.....85)SPD BRPNT AT HI I =	75.00 %
.....86)SPD BRPNT AT LO I =	100.00 %
.....87)CUR LIMIT AT LO I =	100.00 %
.....88)DUAL I CLAMP ENBL =	DISABLED
.....89)UPPER CUR CLAMP =	0.00 % #
.....90)LOWER CUR CLAMP =	0.00 % #
.....91)EXTRA CUR REF =	0.00 %
.....92)AUTOTUNE ENABLE =	DISABLED
.....93)CUR PROP GAIN =	30.00
.....94)CUR INT GAIN =	3.00
.....95)CUR DISCONTINUITY =	13.00 %
.....96)4-QUADRANT MODE =	ENABLED
.....97)SPD BYPASS CUR EN =	DISABLED
<b>FIELD CONTROL 3</b>	
.....99)FIELD ENABLE =	ENABLED
.....100)FIELD VOLTS OP % =	90.00 %
.....101)FIELD PROP GAIN =	10
.....102)FIELD INT GAIN =	100
<b>FLD WEAKENING MENU 4</b>	
.....103)FLD WEAK ENABLE =	DISABLED
.....104)FLD WK PROP GAIN =	50
.....105)FLD WK INT TC ms =	4000
.....106)FLD WK DRV TC ms =	200
.....107)FLD WK FB DRV ms =	100
.....108)FLD WK FB INT ms =	100
.....109)SPILLOVER AVF % =	100.00 %
.....110)MIN FLD CURRENT =	10.00 %
.....111)STANDBY FLD ENBL =	DISABLED
.....112)STANDBY FLD CUR =	25.00 %
.....113)FLD QUENCH DELAY =	10.0 SECS
.....114)FIELD REFERENCE =	100.00 %

<b>ZERO INTERLOCKS 3</b>	
.....115)STANDSTILL ENBL =	DISABLED
.....116)ZERO REF START =	DISABLED
.....117)ZERO INTLK SPD % =	1.00 %
.....118)ZERO INTLK CUR % =	1.50 %
.....119)AT ZERO REF FLAG =	HIGH
.....120)AT ZERO SPD FLAG =	HIGH
.....121)AT STANDSTILL =	HIGH
<b>SPINDLE ORIENTATE 4</b>	
.....122)ZERO SPEED LOCK =	0.00
.....240)MARKER ENABLE =	DISABLED
.....241)MARKER OFFSET =	0
.....242)POSITION REF =	0
.....243)MARKER FREQ MON =	0.00 Hz
.....244)IN POSITION FLAG =	LOW
<b>CALIBRATION 3</b>	
.....2)RATED ARM AMPS =	9.6 AMPS #
.....3)CURRENT LIMIT(%) =	150.00 %
.....4)RATED FIELD AMPS =	2.00 AMPS
.....5)BASE RATED RPM =	1500 RPM
.....6)DESIRED MAX RPM =	1500 RPM
.....7)ZERO SPD OFFSET =	0.00 %
.....8)MAX TACHO VOLTS =	60.00 VOLTS
.....9)SPEED FBK TYPE =	ARMATURE VOLTS
<b>ENCODER SCALING 4</b>	
.....10)QUADRATURE ENABLE =	ENABLED
.....11)ENCODER LINES =	1000
.....12)MOT/ENC SPD RATIO =	1.0000
.....13)ENCODER SIGN =	NON-INVERT
.....14)IR COMPENSATION =	0.00 %
.....15)FIELD CUR FB TRIM =	1.0000
.....16)ARM VOLTS TRIM =	1.0000
.....17)ANALOG TACHO TRIM =	1.0000
.....18)RATED ARM VOLTS =	460.0 VOLTS
.....19)EL1/2/3 RATED AC =	415.0 VOLTS
.....20)MOTOR 1,2 SELECT =	MOTOR 1
<b>DIAGNOSTICS 2</b>	
<b>SPEED LOOP MONITOR 3</b>	
.....123)TOTAL SPD REF MN =	0.00 %
.....124)SPEED DEMAND MON =	0.00 %
.....125)SPEED ERROR MON =	0.00 %
.....126)ARM VOLTS MON =	0.0 VOLTS
.....127)ARM VOLTS % MON =	0.00 %
.....128)BACK EMF % MON =	0.00 %
.....129)TACHO VOLTS MON =	0.00 VOLTS
.....130)MOTOR RPM MON =	0 RPM
.....132)ENCODER RPM MON =	0 RPM
.....131)SPEED FBK MON =	0.00 %
<b>ARM I LOOP MONITOR 3</b>	
.....133)ARM CUR DEM MON =	0.00 %
.....134)ARM CUR % MON =	0.00 %
.....135)ARM CUR AMPS MON =	0.0 AMPS
.....136)UPPER CUR LIM MN =	0.00 %
.....137)LOWER CUR LIM MN =	0.00 %
.....138)ACTUAL UPPER LIM =	0.00 %
.....139)ACTUAL LOWER LIM =	0.00 %
.....140)O/LOAD LIMIT MON =	150.00 %
.....141)AT CURRENT LIMIT =	LOW
<b>FLD I LOOP MONITOR 3</b>	
.....143)FIELD DEMAND MON =	0.00 %
.....144)FIELD CUR % MON =	0.00 %
.....145)FLD CUR AMPS MON =	0.00 AMPS
.....146)ANGLE OF ADVANCE =	0 DEG
.....147)FIELD ACTIVE MON =	DISABLED
<b>ANALOG IO MONITOR 3</b>	
.....150)IUP2 (T2) MON =	0.000 VOLTS
.....151)IUP3 (T3) MON =	0.000 VOLTS
.....152)IUP4 (T4) MON =	0.000 VOLTS
.....153)IUP5 (T5) MON =	0.000 VOLTS
.....154)IUP6 (T6) MON =	0.000 VOLTS
.....155)IUP7 (T7) MON =	0.000 VOLTS
.....156)IUP8 (T8) MON =	0.000 VOLTS
.....157)IUP9 (T9) MON =	0.000 VOLTS
.....159)AOP1 (T10) MON =	0.000 VOLTS
.....160)AOP2 (T11) MON =	0.000 VOLTS
.....161)AOP3 (T12) MON =	0.000 VOLTS
<b>DIGITAL IO MONITOR 3</b>	
.....162)IUP 23456789 =	00000000
.....163)DIP 12341234 DIO =	00000000
.....164)DOP 123TRJSC CIP =	10110000
.....165) + ARM BRIDGE FLAG =	LOW
.....166)DRIVE START FLAG =	LOW
.....167)DRIVE RUN FLAG =	LOW
.....168)RUNNING MODE MON =	STOP
<b>BLOCK OP MONITOR 3</b>	
.....21)RAMP OP MONITOR =	0.00 %
.....45)MP OP MONITOR =	0.00 %
.....192)REF XC MASTER MN =	0.00 %
.....401)SUMMER1 OP MON =	0.00 %
.....415)SUMMER2 OP MON =	0.00 %
.....429)PID1 OP MONITOR =	0.00 %
.....452)PID2 OP MONITOR =	0.00 %
.....475)PROFILE Y OP MON =	0.00 %
.....483)DIAMETER OP MON =	0.00 %
.....494)TOTAL TENSION MN =	0.00 %
.....500)TORQUE DEMAND MN =	0.00 %
.....523)PRESET OP MON =	0.00 %
.....560)LATCH OUTPUT MON =	0.00 %
.....568)FILTER1 OP MON =	0.00 %
.....573)FILTER2 OP MON =	0.00 %
.....578)COUNTER COUNT =	0
.....583)TMR ELAPSED TIME =	0.0 SECS
.....169)EL1/2/3 RMS MON =	0.0 VOLTS

.....170)DC KILOWATTS MON =	0.0
<b>MOTOR DRIVE ALARMS 2</b>	
.....171)SPD TRIP ENABLE =	ENABLED
.....172)SPEED TRIP TOL =	50.00 %
.....173)FLD LOSS TRIP EN =	ENABLED
.....174)DOP SCCT TRIP EN =	DISABLED
.....175)MISSING PULSE EN =	ENABLED
.....176)REF EXCH TRIP EN =	DISABLED
.....177)OVERSPEED DELAY =	5.0 SECS
<b>STALL TRIP MENU 3</b>	
.....178)STALL TRIP ENBL =	ENABLED
.....179)STALL CUR LEVEL =	95.00 %
.....180)STALL DELAY TIME =	10.0 SECS
.....181)ACTIVE TRIP MON =	8100
.....182)STORED TRIP MON =	0000
.....183)EXT TRIP RESET =	ENABLED
<b>SERIAL LINKS 2</b>	
<b>RS232 PORT 1 3</b>	
.....187)PORT1 BAUD RATE =	9600
.....188)PORT1 FUNCTION =	PARAM EXCH SELECT
<b>PARAMETER EXCHANGE 4</b>	
<b>DRIVE TRANSMIT 5</b>	
<b>DRIVE RECEIVE 5</b>	
<b>MENU LIST TO HOST 5</b>	
<b>REFERENCE EXCHANGE 4</b>	
.....189)REF XC SLV RATIO =	1.0000
.....190)REF XC SLV SIGN =	NON-INVERT
.....191)REF XC SLAVE MON =	0.00 %
.....192)REF XC MASTER MN =	0.00 %
.....GET FROM =	400)Block Disconnect
<b>PORT1 COMMS LINK 4</b>	
.....193)PORT1 GROUP ID =	0
.....194)PORT1 UNIT ID =	0
.....195)PORT1 ERROR CODE =	0001
.....196)P1 DOP3 RTS MODE =	DISABLED
<b>DISPLAY FUNCTIONS 2</b>	
.....REDUCED MENU ENABLE =	DISABLED
<b>PASSWORD CONTROL 3</b>	
.....ENTER PASSWORD =	0000
.....ALTER PASSWORD =	0000
.....LANGUAGE SELECT =	0
<b>SOFTWARE VERSION</b>	
<b>APPLICATION BLOCKS 2</b>	
<b>SUMMER 1 3</b>	
.....401)SUMMER1 OP MON =	0.00 %
.....402)SUMMER1 SIGN1 =	NON-INVERT
.....403)SUMMER1 RPN2 =	NON-INVERT
.....404)SUMMER1 RATIO1 =	1.0000
.....405)SUMMER1 RATIO2 =	1.0000
.....406)SUMMER1 DIVIDER1 =	1.0000
.....407)SUMMER1 DIVIDER2 =	1.0000
.....408)SUMMER1 INPUT1 =	0.00 %
.....409)SUMMER1 INPUT2 =	0.00 %
.....410)SUMMER1 INPUT3 =	0.00 %
.....411)SUMMER1 DEADBAND =	0.00 %
.....412)SUMMER1 OP INVRT =	NON-INVERT
.....413)SUMMER1 CLAMP =	105.00 %
<b>SUMMER 2 3</b>	
.....415)SUMMER2 OP MON =	0.00 %
.....416)SUMMER2 SIGN1 =	NON-INVERT
.....417)SUMMER2 SIGN2 =	NON-INVERT
.....418)SUMMER2 RATIO1 =	1.0000
.....419)SUMMER2 RATIO2 =	1.0000
.....420)SUMMER2 DIVIDER1 =	1.0000
.....421)SUMMER2 DIVIDER2 =	1.0000
.....422)SUMMER2 INPUT1 =	0.00 %
.....423)SUMMER2 INPUT2 =	0.00 %
.....424)SUMMER2 INPUT3 =	0.00 %
.....425)SUMMER2 DEADBAND =	0.00 %
.....426)SUMMER2 OP INVRT =	NON-INVERT
.....427)SUMMER2 CLAMP =	105.00 %
<b>PID 1 3</b>	
.....429)PID1 OP MONITOR =	0.00 %
.....430)PID1 INPUT1 =	0.00 %
.....431)PID1 RATIO1 =	1.0000
.....432)PID1 DIVIDER1 =	1.0000
.....433)PID1 INPUT2 =	0.00 %
.....434)PID1 RATIO2 =	1.0000
.....435)PID1 DIVIDER2 =	1.0000
.....436)PID1 PROP GAIN =	1.0
.....437)PID1 INTEGRAL TC =	5.00 SECS
.....438)PID1 DERIV TC =	0.000 SECS
.....439)PID1 FILTER TC =	0.100 SECS
.....440)PID1 INT PRESET =	DISABLED
.....441)PID1 PRESET VAL =	0.00 %
.....442)PID1 RESET =	DISABLED
.....443)PID1 POS CLAMP =	100.00 %
.....444)PID1 NEG CLAMP =	-100.00 %
.....445)PID1 OUTPUT TRIM =	0.2000
.....446)PID1 PROFL MODE =	0
.....447)PID1 MIN PROP GN =	20.00 %
.....448)PID1 X-AXIS MIN =	0.00 %
.....PID1 X-AXIS GET FROM =	400)Block Disconnect
.....449)PID1 PROFILED GN =	0.0
.....450)PID1 CLAMP FLAG =	LOW
.....451)PID1 ERROR MON =	0.00 %
<b>PID 2 3</b>	
.....452)PID2 OP MONITOR =	0.00 %
.....453)PID2 INPUT1 =	0.00 %
.....454)PID2 RATIO1 =	1.0000
.....455)PID2 DIVIDER1 =	1.0000
.....456)PID2 INPUT2 =	0.00 %
.....457)PID2 RATIO2 =	1.0000

.....458)PID2 DIVIDER2 = 1.0000
.....459)PID2 PROP GAIN = 1.0
.....460)PID2 INTEGRAL TC = 5.00 SECS
.....461)PID2 DERIV TC = 0.000 SECS
.....462)PID2 FILTER TC = 0.100 SECS
.....463)PID2 INT PRESET = DISABLED
.....464)PID2 PRESET VAL = 0.00 %
.....465)PID2 RESET = DISABLED
.....466)PID2 POS CLAMP = 100.00 %
.....467)PID2 NEG CLAMP = -100.00 %
.....468)PID2 OUTPUT TRIM = 0.2000
.....469)PID2 PROFIL MODE = 0
.....470)PID2 MIN PROP GN = 20.00 %
.....471)PID2 X-AXIS MIN = 0.00 %
.....PID2 X-AXIS GET FROM = 400)Block Disconnect
.....472)PID2 PROFILED GN = 0.0
.....473)PID2 CLAMP FLAG = LOW
.....474)PID2 ERROR MON = 0.00 %
<b>PARAMETER PROFILER 3</b>
.....475)PROFILE Y OP MON = 0.00 %
.....476)PROFILER MODE = 0
.....477)PROFLR Y AT Xmin = 0.00 %
.....478)PROFLR Y AT Xmax = 100.00 %
.....479)PROFILER Xmin = 0.00 %
.....480)PROFILER Xmax = 100.00 %
.....481)PROFLR X RECTIFY = ENABLED
.....PRFL X-AXIS GET FROM = 400)Block Disconnect
<b>REEL DIAMETER CALC 3</b>
.....483)DIAMETER OP MON = 0.00 %
.....484)DIA WEB SPEED IP = 0.00 %
.....485)DIA REEL SPD IP = 0.00 %
.....486)DIAMETER MIN = 10.00 %
.....487)DIA MIN SPEED = 5.00 %
.....488)DIAMETER HOLD = DISABLED
.....489)DIA FILTER TC = 5.00 SECS
.....490)DIAMETER PRESET = DISABLED
.....491)DIA PRESET VALUE = 10.00 %
.....492)DIA WEB BRK THR. = 7.50 %
.....493)DIA MEM BOOT-UP = DISABLED
<b>TAPER TENSION CALC 3</b>
.....494)TOTAL TENSION MN = 0.00 %
.....495)TENSION REF = 0.00 %
.....496)TAPER STRENGTH = 0.00 %
.....497)HYPERBOLIC TAPER = DISABLED
.....498)TENSION TRIM IP = 0.00 %
.....499)TAPERED TENS.MON = 0.00 %
<b>TORQUE COMPENSATOR 3</b>
.....500)TORQUE DEMAND MN = 0.00 %
.....501)TORQUE TRIM IP = 0.00 %
.....502)STICTION COMP = 0.00 %
.....503)STIC.WEB SPD THR = 5.00 %
.....504)STATIC FRICTION = 0.00 %
.....505)DYNAMIC FRICTION = 0.00 %
.....506)FRICTION SIGN = NON-INVERT
.....507)FIXED INERTIA = 0.00 %
.....508)VARIABLE INERTIA = 0.00 %
.....509)MATERIAL WIDTH = 100.00 %
.....510)ACCEL LINE SPEED = 0.00 %
.....511)ACCEL SCALER = 10.00
.....512)ACCEL INPUT/MON = 0.00 %
.....513)ACCEL FILTER TC = 0.10 SECS
.....514)TENSION DEM IP = 0.00 %
.....515)TENSION SCALER = 1.0000
.....516)TORQUE MEM SEL = DISABLED
.....517)TORQUE MEM INPUT = 0.00 %
.....518)TENSION ENABLE = ENABLED
.....519)OVER/UNDERWIND = ENABLED
.....520)INERTIA COMP MON = 0.00 %
<b>PRESET SPEED 3</b>
.....523)PRESET OP MON = 0.00 %
.....524)PRESET SEL1(LSB) = LOW
.....525)PRESET SELECT 2 = LOW
.....526)PRESET SEL3(MSB) = LOW
.....527)PR.VALUE FOR 000 = 0.00 %
.....528)PR.VALUE FOR 001 = 0.00 %
.....529)PR.VALUE FOR 010 = 0.00 %
.....530)PR.VALUE FOR 011 = 0.00 %
.....531)PR.VALUE FOR 100 = 0.00 %
.....532)PR.VALUE FOR 101 = 0.00 %
.....533)PR.VALUE FOR 110 = 0.00 %
.....534)PR.VALUE FOR 111 = 0.00 %
<b>MULTI-FUNCTION 1 3</b>
.....544)MULTIFUN1 MODE = C/O SWITCH or JUMPER
.....545)MULTIFUN1 OP SEL = DISABLED
.....GET FROM = 400)Block Disconnect
.....AUX GET FROM = 400)Block Disconnect
.....GOTO = 400)Block Disconnect
<b>MULTI-FUNCTION 2 3</b>
.....546)MULTIFUN2 MODE = C/O SWITCH or JUMPER
.....547)MULTIFUN2 OP SEL = DISABLED
.....GET FROM = 400)Block Disconnect
.....AUX GET FROM = 400)Block Disconnect
.....GOTO = 400)Block Disconnect
<b>MULTI-FUNCTION 3 3</b>
.....548)MULTIFUN3 MODE = C/O SWITCH or JUMPER
.....549)MULTIFUN3 OP SEL = DISABLED
.....GET FROM = 400)Block Disconnect
.....AUX GET FROM = 400)Block Disconnect
.....GOTO = 400)Block Disconnect
<b>MULTI-FUNCTION 4 3</b>
.....550)MULTIFUN4 MODE = C/O SWITCH or JUMPER
.....551)MULTIFUN4 OP SEL = DISABLED
.....GET FROM = 400)Block Disconnect
.....AUX GET FROM = 400)Block Disconnect
.....GOTO = 400)Block Disconnect
<b>MULTI-FUNCTION 5 3</b>
.....552)MULTIFUN5 MODE = C/O SWITCH or JUMPER

.....553)MULTIFUN5 OP SEL = DISABLED
.....GET FROM = 400)Block Disconnect
.....AUX GET FROM = 400)Block Disconnect
.....GOTO = 400)Block Disconnect
<b>MULTI-FUNCTION 6 3</b>
.....554)MULTIFUN6 MODE = C/O SWITCH or JUMPER
.....555)MULTIFUN6 OP SEL = DISABLED
.....GET FROM = 400)Block Disconnect
.....AUX GET FROM = 400)Block Disconnect
.....GOTO = 400)Block Disconnect
<b>MULTI-FUNCTION 7 3</b>
.....556)MULTIFUN7 MODE = C/O SWITCH or JUMPER
.....557)MULTIFUN7 OP SEL = DISABLED
.....GET FROM = 400)Block Disconnect
.....AUX GET FROM = 400)Block Disconnect
.....GOTO = 400)Block Disconnect
<b>MULTI-FUNCTION 8 3</b>
.....558)MULTIFUN8 MODE = C/O SWITCH or JUMPER
.....559)MULTIFUN8 OP SEL = DISABLED
.....GET FROM = 400)Block Disconnect
.....AUX GET FROM = 400)Block Disconnect
.....GOTO = 400)Block Disconnect
<b>LATCH 3</b>
.....560)LATCH OUTPUT MON = 0.00 %
.....561)LATCH DATA IP = LOW
.....562)LATCH CLOCK IP = LOW
.....563)LATCH SET IP = LOW
.....564)LATCH RESET IP = LOW
.....565)LATCH HI VALUE = 0.01 %
.....566)LATCH LO VALUE = 0.00 %
<b>FILTER 1 3</b>
.....568)FILTER1 OP MON = 0.00 %
.....569)FILTER1 TC = 1.000 SECS
.....GET FROM = 400)Block Disconnect
<b>FILTER 2 3</b>
.....573)FILTER2 OP MON = 0.00 %
.....574)FILTER2 TC = 1.000 SECS
.....GET FROM = 400)Block Disconnect
<b>BATCH COUNTER 3</b>
.....578)COUNTER COUNT = 0
.....579)COUNTER CLOCK = LOW
.....580)COUNTER RESET = LOW
.....581)COUNTER TARGET = 32000
.....582)COUNTER> = TARGET = LOW
<b>INTERVAL TIMER 3</b>
.....583)TMR ELAPSED TIME = 0.0 SECS
.....584)TIMER RESET = LOW
.....585)TIMER INTERVAL = 5.0 SECS
.....586)TMR EXPIRED FLAG = LOW
<b>COMPARATOR 1 3</b>
.....588)COMP1 INPUT 1 = 0.00 %
.....589)COMP1 INPUT 2 = 0.00 %
.....590)COMP1 WINDOW SEL = DISABLED
.....591)COMP1 HYSTERESIS = 0.50 %
.....GOTO = 400)Block Disconnect
<b>COMPARATOR 2 3</b>
.....592)COMP2 INPUT 1 = 0.00 %
.....593)COMP2 INPUT 2 = 0.00 %
.....594)COMP2 WINDOW SEL = DISABLED
.....595)COMP2 HYSTERESIS = 0.50 %
.....GOTO = 400)Block Disconnect
<b>COMPARATOR 3 3</b>
.....596)COMP3 INPUT 1 = 0.00 %
.....597)COMP3 INPUT 2 = 0.00 %
.....598)COMP3 WINDOW SEL = DISABLED
.....599)COMP3 HYSTERESIS = 0.50 %
.....GOTO = 400)Block Disconnect
<b>COMPARATOR 4 3</b>
.....600)COMP4 INPUT 1 = 0.00 %
.....601)COMP4 INPUT 2 = 0.00 %
.....602)COMP4 WINDOW SEL = DISABLED
.....603)COMP4 HYSTERESIS = 0.50 %
.....GOTO = 400)Block Disconnect
<b>C/O SWITCH 1 3</b>
.....604)C/O SW1 CONTROL = LOW
.....605)C/O SW1 HI VALUE = 0.01 %
.....606)C/O SW1 LO VALUE = 0.00 %
.....GOTO = 400)Block Disconnect
<b>C/O SWITCH 2 3</b>
.....607)C/O SW2 CONTROL = LOW
.....608)C/O SW2 HI VALUE = 0.01 %
.....609)C/O SW2 LO VALUE = 0.00 %
.....GOTO = 400)Block Disconnect
<b>C/O SWITCH 3 3</b>
.....610)C/O SW3 CONTROL = LOW
.....611)C/O SW3 HI VALUE = 0.01 %
.....612)C/O SW3 LO VALUE = 0.00 %
.....GOTO = 400)Block Disconnect
<b>C/O SWITCH 4 3</b>
.....613)C/O SW4 CONTROL = LOW
.....614)C/O SW4 HI VALUE = 0.01 %
.....615)C/O SW4 LO VALUE = 0.00 %
.....GOTO = 400)Block Disconnect
<b>CONFIGURATION 2</b>
.....ENABLE GOTO,GETFROM = DISABLED
<b>UNIVERSAL INPUTS 3</b>
<b>UIP2 (T2) SETUP 4</b>
.....320)UIP2 IP RANGE = 0
.....321)UIP2 IP OFFSET = 0.00 %
.....322)UIP2 CAL RATIO = 1.0000
.....323)UIP2 MAX CLAMP = 100.00 %
.....324)UIP2 MIN CLAMP = -100.00 %
.....UIP ANALOG GOTO = 63)SPEED REF 2
.....UIP DIGITAL OP1 GOTO = 400)Block Disconnect
.....UIP DIGITAL OP2 GOTO = 400)Block Disconnect
.....325)UIP2 HI VAL OP1 = 0.01 %
.....326)UIP2 LO VAL OP1 = 0.00 %

.....327)UIP2 HI VAL OP2 = 0.01 %
.....328)UIP2 LO VAL OP2 = 0.00 %
.....329)UIP2 THRESHOLD = 6.000 VOLTS
<b>UIP3 (T3) SETUP 4</b>
.....330)UIP3 IP RANGE = 0
.....331)UIP3 IP OFFSET = 0.00 %
.....332)UIP3 CAL RATIO = 1.0000
.....333)UIP3 MAX CLAMP = 100.00 %
.....334)UIP3 MIN CLAMP = -100.00 %
.....UIP ANALOG GOTO = 400)Block Disconnect
.....UIP DIGITAL OP1 GOTO = 400)Block Disconnect
.....UIP DIGITAL OP2 GOTO = 400)Block Disconnect
.....335)UIP3 HI VAL OP1 = 0.01 %
.....336)UIP3 LO VAL OP1 = 0.00 %
.....337)UIP3 HI VAL OP2 = 0.01 %
.....338)UIP3 LO VAL OP2 = 0.00 %
.....339)UIP3 THRESHOLD = 6.000 VOLTS
<b>UIP4 (T4) SETUP 4</b>
.....340)UIP4 IP RANGE = 0
.....341)UIP4 IP OFFSET = 0.00 %
.....342)UIP4 CAL RATIO = 1.0000
.....343)UIP4 MAX CLAMP = 100.00 %
.....344)UIP4 MIN CLAMP = -100.00 %
.....UIP ANALOG GOTO = 26)RAMP INPUT
.....UIP DIGITAL OP1 GOTO = 400)Block Disconnect
.....UIP DIGITAL OP2 GOTO = 400)Block Disconnect
.....345)UIP4 HI VAL OP1 = 0.01 %
.....346)UIP4 LO VAL OP1 = 0.00 %
.....347)UIP4 HI VAL OP2 = 0.01 %
.....348)UIP4 LO VAL OP2 = 0.00 %
.....349)UIP4 THRESHOLD = 6.000 VOLTS
<b>UIP5 (T5) SETUP 4</b>
.....350)UIP5 IP RANGE = 0
.....351)UIP5 IP OFFSET = 0.00 %
.....352)UIP5 CAL RATIO = 1.0000
.....353)UIP5 MAX CLAMP = 100.00 %
.....354)UIP5 MIN CLAMP = -100.00 %
.....UIP ANALOG GOTO = 90)LOWER CUR CLAMP
.....UIP DIGITAL OP1 GOTO = 400)Block Disconnect
.....UIP DIGITAL OP2 GOTO = 400)Block Disconnect
.....355)UIP5 HI VAL OP1 = 0.01 %
.....356)UIP5 LO VAL OP1 = 0.00 %
.....357)UIP5 HI VAL OP2 = 0.01 %
.....358)UIP5 LO VAL OP2 = 0.00 %
.....359)UIP5 THRESHOLD = 6.000 VOLTS
<b>UIP6 (T6) SETUP 4</b>
.....360)UIP6 IP RANGE = 0
.....361)UIP6 IP OFFSET = 0.00 %
.....362)UIP6 CAL RATIO = 1.0000
.....363)UIP6 MAX CLAMP = 100.00 %
.....364)UIP6 MIN CLAMP = -100.00 %
.....UIP ANALOG GOTO = 89)UPPER CUR CLAMP
.....UIP DIGITAL OP1 GOTO = 400)Block Disconnect
.....UIP DIGITAL OP2 GOTO = 400)Block Disconnect
.....365)UIP6 HI VAL OP1 = 0.01 %
.....366)UIP6 LO VAL OP1 = 0.00 %
.....367)UIP6 HI VAL OP2 = 0.01 %
.....368)UIP6 LO VAL OP2 = 0.00 %
.....369)UIP6 THRESHOLD = 6.000 VOLTS
<b>UIP7 (T7) SETUP 4</b>
.....370)UIP7 IP RANGE = 0
.....371)UIP7 IP OFFSET = 0.00 %
.....372)UIP7 CAL RATIO = 1.0000
.....373)UIP7 MAX CLAMP = 100.00 %
.....374)UIP7 MIN CLAMP = -100.00 %
.....UIP ANALOG GOTO = 400)Block Disconnect
.....UIP DIGITAL OP1 GOTO = 52)IMP PRESET
.....UIP DIGITAL OP2 GOTO = 400)Block Disconnect
.....375)UIP7 HI VAL OP1 = 0.01 %
.....376)UIP7 LO VAL OP1 = 0.00 %
.....377)UIP7 HI VAL OP2 = 0.01 %
.....378)UIP7 LO VAL OP2 = 0.00 %
.....379)UIP7 THRESHOLD = 6.000 VOLTS
<b>UIP8 (T8) SETUP 4</b>
.....380)UIP8 IP RANGE = 0
.....381)UIP8 IP OFFSET = 0.00 %
.....382)UIP8 CAL RATIO = 1.0000
.....383)UIP8 MAX CLAMP = 100.00 %
.....384)UIP8 MIN CLAMP = -100.00 %
.....UIP ANALOG GOTO = 400)Block Disconnect
.....UIP DIGITAL OP1 GOTO = 48)IMP UP COMMAND
.....UIP DIGITAL OP2 GOTO = 400)Block Disconnect
.....385)UIP8 HI VAL OP1 = 0.01 %
.....386)UIP8 LO VAL OP1 = 0.00 %
.....387)UIP8 HI VAL OP2 = 0.01 %
.....388)UIP8 LO VAL OP2 = 0.00 %
.....389)UIP8 THRESHOLD = 6.000 VOLTS
<b>UIP9 (T9) SETUP 4</b>
.....390)UIP9 IP RANGE = 0
.....391)UIP9 IP OFFSET = 0.00 %
.....392)UIP9 CAL RATIO = 1.0000
.....393)UIP9 MAX CLAMP = 100.00 %
.....394)UIP9 MIN CLAMP = 100.00 %
.....UIP ANALOG GOTO = 400)Block Disconnect
.....UIP DIGITAL OP1 GOTO = 49)IMP DOWN COMMAND
.....UIP DIGITAL OP2 GOTO = 400)Block Disconnect
.....395)UIP9 HI VAL OP1 = 0.01 %
.....396)UIP9 LO VAL OP1 = 0.00 %
.....397)UIP9 HI VAL OP2 = 0.01 %
.....398)UIP9 LO VAL OP2 = 0.00 %
.....399)UIP9 THRESHOLD = 6.000 VOLTS
<b>ANALOG OUTPUTS 3</b>
.....250)Iarm OP RECTIFY = DISABLED
<b>AOP1 (T10) SETUP 4</b>
.....251)AOP1 DIVIDER = 1.0000
.....252)AOP1 OFFSET = 0.00 %
.....253)AOP1 RECTIFY EN = DISABLED

..... GET FROM = 715)SPD FBK % UNF
<b>AOP2 (T11) SETUP 4</b>
..... 254)AOP2 DIVIDER = 1.0000
..... 255)AOP2 OFFSET = 0.00 %
..... 256)AOP2 RECTIFY EN = DISABLED
..... GET FROM = 123)TOTAL SPD REF MN
<b>AOP3 (T12) SETUP 4</b>
..... 257)AOP3 DIVIDER = 1.0000
..... 258)AOP3 OFFSET = 0.00 %
..... 259)AOP3 RECTIFY EN = DISABLED
..... GET FROM = 718)CUR DEMAND UNF
..... 260)SCOPE OF SELECT = DISABLED
<b>DIGITAL INPUTS 3</b>
<b>DIP1 (T14) SETUP 4</b>
..... 310)DIP1 IP HI VALUE = 0.01 %
..... 311)DIP1 IP LO VALUE = 0.00 %
..... GOTO = 400)Block Disconnect
<b>DIP2 (T15) SETUP 4</b>
..... 312)DIP2 IP HI VALUE = 0.01 %
..... 313)DIP2 IP LO VALUE = 0.00 %
..... GOTO = 400)Block Disconnect
<b>DIP3 (T16) SETUP 4</b>
..... 314)DIP3 IP HI VALUE = 0.01 %
..... 315)DIP3 IP LO VALUE = 0.00 %
..... GOTO = 400)Block Disconnect
<b>DIP4 (T17) SETUP 4</b>
..... 316)DIP4 IP HI VALUE = 0.01 %
..... 317)DIP4 IP LO VALUE = 0.00 %
..... GOTO = 400)Block Disconnect
<b>RUN IP SETUP 4</b>
..... 318)RUN IP HI VALUE = 0.01 %
..... 319)RUN IP LO VALUE = 0.00 %
..... GOTO = 308)INTERNAL RUN IP
<b>DIGITAL IN/OUTPUTS 3</b>
<b>DIO1 (T18) SETUP 4</b>
..... 271)DIO1 OP MODE = DISABLED
..... 272)DIO1 RECTIFY EN = ENABLED
..... 273)DIO1 THRESHOLD = 0.00 %
..... 274)DIO1 INVERT MODE = NON-INVERT
..... GET FROM = 400)Block Disconnect
..... GOTO = 116)ZERO REF START
..... 275)DIO1 IP HI VALUE = 0.01 %
..... 276)DIO1 IP LO VALUE = 0.00 %
<b>DIO2 (T19) SETUP 4</b>
..... 277)DIO2 OP MODE = DISABLED
..... 278)DIO2 RECTIFY EN = ENABLED
..... 279)DIO2 THRESHOLD = 0.00 %
..... 280)DIO2 INVERT MODE = NON-INVERT
..... GET FROM = 400)Block Disconnect
..... GOTO = 42)JOG MODE SELECT
..... 281)DIO2 IP HI VALUE = 0.01 %
..... 282)DIO2 IP LO VALUE = 0.00 %
<b>DIO3 (T20) SETUP 4</b>
..... 283)DIO3 OP MODE = DISABLED
..... 284)DIO3 RECTIFY EN = ENABLED
..... 285)DIO3 THRESHOLD = 0.00 %
..... 286)DIO3 INVERT MODE = NON-INVERT
..... GET FROM = 400)Block Disconnect
..... GOTO = 33)RAMP HOLD
..... 287)DIO3 IP HI VALUE = 0.01 %
..... 288)DIO3 IP LO VALUE = 0.00 %
<b>DIO4 (T21) SETUP 4</b>
..... 289)DIO4 OP MODE = DISABLED
..... 290)DIO4 RECTIFY EN = ENABLED
..... 291)DIO4 THRESHOLD = 0.00 %
..... 292)DIO4 INVERT MODE = NON-INVERT
..... GET FROM = 400)Block Disconnect
..... GOTO = 88)DUAL I CLAMP ENBL
..... 293)DIO4 IP HI VALUE = 0.01 %
..... 294)DIO4 IP LO VALUE = 0.00 %
<b>DIGITAL OUTPUTS 3</b>
<b>DOP1 (T22) SETUP 4</b>
..... 261)DOP1 RECTIFY EN = ENABLED
..... 262)DOP1 THRESHOLD = 0.00 %
..... 263)DOP1 INVERT MODE = NON-INVERT
..... GET FROM = 120)AT ZERO SPD FLAG
<b>DOP2 (T23) SETUP 4</b>
..... 264)DOP2 RECTIFY EN = ENABLED
..... 265)DOP2 THRESHOLD = 0.00 %
..... 266)DOP2 INVERT MODE = NON-INVERT
..... GET FROM = 35)RAMPING FLAG
<b>DOP3 (T24) SETUP 4</b>
..... 267)DOP3 RECTIFY EN = ENABLED
..... 268)DOP3 THRESHOLD = 0.00 %
..... 269)DOP3 INVERT MODE = NON-INVERT
..... GET FROM = 698)HEALTHY FLAG
<b>STAGING POSTS 3</b>
..... 296)DIGITAL POST 1 = LOW
..... 297)DIGITAL POST 2 = LOW
..... 298)DIGITAL POST 3 = LOW
..... 299)DIGITAL POST 4 = LOW
..... 300)ANALOG POST 1 = 0.00 %
..... 301)ANALOG POST 2 = 0.00 %
..... 302)ANALOG POST 3 = 0.00 %
..... 303)ANALOG POST 4 = 0.00 %
<b>SOFTWARE TERMINALS 3</b>
..... 305)ANDED RUN = HIGH
..... 306)ANDED JOG = HIGH
..... 307)ANDED START = HIGH
..... 308)INTERNAL RUN IP = LOW
<b>JUMPER CONNECTIONS 3</b>
<b>JUMPER 1 4</b>
..... GET FROM = 400)Block Disconnect
..... GOTO = 400)Block Disconnect
<b>JUMPER 2 4</b>
..... GET FROM = 400)Block Disconnect
..... GOTO = 400)Block Disconnect

<b>JUMPER 3 4</b>
..... GET FROM = 400)Block Disconnect
..... GOTO = 400)Block Disconnect
<b>JUMPER 4 4</b>
..... GET FROM = 400)Block Disconnect
..... GOTO = 400)Block Disconnect
<b>JUMPER 5 4</b>
..... GET FROM = 400)Block Disconnect
..... GOTO = 400)Block Disconnect
<b>JUMPER 6 4</b>
..... GET FROM = 400)Block Disconnect
..... GOTO = 400)Block Disconnect
<b>JUMPER 7 4</b>
..... GET FROM = 400)Block Disconnect
..... GOTO = 400)Block Disconnect
<b>JUMPER 8 4</b>
..... GET FROM = 400)Block Disconnect
..... GOTO = 400)Block Disconnect
<b>JUMPER 9 4</b>
..... GET FROM = 400)Block Disconnect
..... GOTO = 400)Block Disconnect
<b>JUMPER 10 4</b>
..... GET FROM = 400)Block Disconnect
..... GOTO = 400)Block Disconnect
<b>JUMPER 11 4</b>
..... GET FROM = 400)Block Disconnect
..... GOTO = 400)Block Disconnect
<b>JUMPER 12 4</b>
..... GET FROM = 400)Block Disconnect
..... GOTO = 400)Block Disconnect
<b>JUMPER 13 4</b>
..... GET FROM = 400)Block Disconnect
..... GOTO = 400)Block Disconnect
<b>JUMPER 14 4</b>
..... GET FROM = 400)Block Disconnect
..... GOTO = 400)Block Disconnect
<b>JUMPER 15 4</b>
..... GET FROM = 400)Block Disconnect
..... GOTO = 400)Block Disconnect
<b>JUMPER 16 4</b>
..... GET FROM = 400)Block Disconnect
..... GOTO = 400)Block Disconnect
<b>BLOCK OP CONFIG 3</b>
..... RUN MODE RAMPS GOTO = 65)RAMPED SPD REF 4
..... MOTORIZED SLO GOTO = 62)INT SPEED REF 1
..... REF EXCH SLAVE GOTO = 400)Block Disconnect
..... SUMMER1 GOTO = 400)Block Disconnect
..... SUMMER2 GOTO = 400)Block Disconnect
..... PID1 GOTO = 400)Block Disconnect
..... PID2 GOTO = 400)Block Disconnect
..... PARAMETER PROFL GOTO = 400)Block Disconnect
..... DIAMETER CALC GOTO = 400)Block Disconnect
..... TAPER CALC GOTO = 400)Block Disconnect
..... T/COMP +CUR LIM GOTO = 400)Block Disconnect
..... T/COMP -CUR LIM GOTO = 400)Block Disconnect
..... PRESET SPEED GOTO = 400)Block Disconnect
..... LATCH GOTO = 400)Block Disconnect
..... FILTER1 GOTO = 400)Block Disconnect
..... FILTER2 GOTO = 400)Block Disconnect
..... BATCH COUNTER GOTO = 400)Block Disconnect
..... INTERVAL TIMER GOTO = 400)Block Disconnect
<b>FIELDBUS CONFIG 3</b>
<b>c JUMPER 1 4</b>
..... GET FROM = 400)Block Disconnect
<b>JUMPER 2 4</b>
..... GET FROM = 400)Block Disconnect
<b>JUMPER 3 4</b>
..... GET FROM = 400)Block Disconnect
<b>JUMPER 4 4</b>
..... GET FROM = 400)Block Disconnect
<b>JUMPER 5 4</b>
..... GET FROM = 400)Block Disconnect
<b>JUMPER 6 4</b>
..... GET FROM = 400)Block Disconnect
<b>JUMPER 7 4</b>
..... GET FROM = 400)Block Disconnect
<b>JUMPER 8 4</b>
..... GET FROM = 400)Block Disconnect
<b>JUMPER 9 4</b>
..... GET FROM = 400)Block Disconnect
..... GOTO = 400)Block Disconnect
<b>JUMPER 10 4</b>
..... GOTO = 400)Block Disconnect
<b>JUMPER 11 4</b>
..... GOTO = 400)Block Disconnect
<b>JUMPER 12 4</b>
..... GOTO = 400)Block Disconnect
<b>JUMPER 13 4</b>
..... GOTO = 400)Block Disconnect
<b>JUMPER 14 4</b>
..... GOTO = 400)Block Disconnect

<b>JUMPER 15 4</b>
..... GOTO = 400)Block Disconnect
<b>JUMPER 16 4</b>
..... GOTO = 400)Block Disconnect
<b>BIT-PACKED GOTO</b>
<b>JUMPER 1 4</b>
..... GOTO = 400)Block Disconnect
<b>JUMPER 2 4</b>
..... GOTO = 400)Block Disconnect
<b>JUMPER 3 4</b>
..... GOTO = 400)Block Disconnect
<b>JUMPER 4 4</b>
..... GOTO = 400)Block Disconnect
<b>JUMPER 5 4</b>
..... GOTO = 400)Block Disconnect
<b>JUMPER 6 4</b>
..... GOTO = 400)Block Disconnect
<b>JUMPER 7 4</b>
..... GOTO = 400)Block Disconnect
<b>JUMPER 8 4</b>
..... GOTO = 400)Block Disconnect
<b>199)FBUS DATA CONTRL = 00000000</b>
..... IF FIRE ANGLE BSTOP = 155
..... FLD CUR SAMPLE DELAY = 20
..... TEST SWITCH = DISABLED
..... PPDET AMPLITUDE COMP = 250
..... PPDET INTERVAL COMP = 400
..... TEST VARIABLE = 230
..... SCAN Ia DEMAND LEVEL = 4
..... SCAN TIME-OUT = 10
..... EMF CALC Ia FB LEVEL = 7
..... ZERO Ia DETECT LEVEL = 6
..... Iarm FBK CALIBRATION = ENABLED
..... Ia AVE NULL ADJUST = 2 #
..... Ia INST NULL ADJUST = 0
..... Ia FEEDFORWARD GAIN = 1.00
..... AOP3 USER CONFIGURED = ENABLED
..... GLOBAL HLTH OVERRIDE = 0000
..... HIGH B/W TACH SAMPLE = DISABLED
..... LP FILTER LAG = 0.20 SECS
..... DISPLAY AVERAGE LAG = 0.50 SECS
..... DISPLAY REFRESH TIME = 1080
..... OP-MODE STEP NUMBER = 3
..... UP EXECUTION TIME = 9829
..... PLL ERROR MONITOR = 0
<b>CONFLICT HELP MENU 3</b>
..... NUMBER OF CONFLICTS = 0
..... MULTIPLE GOTO ON PIN = 400
<b>PARAMETER SAVE 2</b>
0

## 16 Index

### ALARMS

Digital OP short circuit trip enable PIN 174	25, 139, 146
DRIVE TRIP MESSAGE	32, 143
Field loss trip enable PIN 173	139, 144
menu	18, 136
Missing pulse trip enable PIN 175	44, 140, 145, 221
Overspeed delay time PIN 177	140, 144, 221
Reference exchange trip enable PIN 176	140, 146
Speed feedback mismatch tolerance PIN 172	138, 139
Speed feedback mismatch trip enable PIN 171	18, 63, 64, 65, 137, 145
Stall current level PIN 179	100, 141, 221
Stall time PIN 180	141
Stall trip enable PIN 178	18, 141, 145, 221
STALL TRIP MENU	141
Trip monitors PINS 181 / 182	142
Trip reset enable PIN 183	143, 221

### ANALOG OUTPUTS

AOP1/2/3 Dividing factor PINS 251 / 254 / 257	179
AOP1/2/3 Make output GET FROM source connection	179
AOP1/2/3 Offset PINS 252 / 255 / 258	179
AOP1/2/3 Rectify mode enable PINS 253 / 256 / 259	179
AOP1/2/3/4 SETUP	178
Scope output select PIN 260	130, 180, 188

Analogue inputs ..... 25, 26, 130, 165

Analogue tachogenerator input ..... 27, 63, 64

APPLICATION BLOCKS ..... 3, 165, 168, 226

### APPLICATION BLOCKS

Activating blocks	166
Application blocks PIN table	166
General rules	165
Logic levels	166
Order of processing	165
Sample times	165

Approvals UL, cUL, CE ..... 217

Archiving PL/X recipes ..... 56, 150, 154, 155, 156, 157, 160, 168, 197

Basic speed or torque control ..... 34

Block Disconnect PIN 400 ..... 171

Branch hopping between monitor windows ..... 47

Breakdown ..... 3, 218

### CALIBRATION

Analog tachometer trim PIN 17	69
Armature volts trim PIN 16	68, 219
Base rated motor rpm PIN 5	62, 219
Block diagram	60
Current limit (%) PIN 3	61
Desired max rpm PIN 6	17, 62, 219
EL1/2/3 rated AC volts PIN 19	69, 145, 214
Encoder lines PIN 11	67, 219
ENCODER SCALING	26, 65, 116, 180
Encoder sign PIN 13	67, 219
Field current feedback trim PIN 15	68, 106, 219
IR compensation PIN 14	68, 109, 219
Max tachometer volts PIN 8	63, 219
Motor / encoder speed ratio PIN 12	67, 124, 219
Motor 1 or 2 select PIN 20	44, 48, 70, 163, 196
Quadrature enable PIN 10	66, 219
Rated armature amps PIN 2	60, 219
Rated armature volts PIN 18	69, 219
Rated field amps PIN 4	44, 61, 112, 219
Speed feedback type PIN 9	17, 27, 63, 64, 66, 118, 219
Zero speed offset PIN 7	62, 219

CE Emissions ..... 217

CE Immunity ..... 217

### CHANGE PARAMETERS

CALIBRATION	42, 43, 59
STOP MODE RAMP	35, 38, 39, 71, 85

CHANGE PARAMETERS / CURRENT CONTROL ..... 43, 97

CHANGE PARAMETERS / FIELD CONTROL ..... 17, 29, 61, 62, 69, 106

CHANGE PARAMETERS / JOG CRAWL SLACK ..... 71, 77

CHANGE PARAMETERS / MOTORISED POT RAMP ..... 81

CHANGE PARAMETERS / RUN MODE RAMPS ..... 43, 71, 90, 122

CHANGE PARAMETERS / SPEED CONTROL ..... 90, 92, 161

CHANGE PARAMETERS / SPEED REF SUMMER ..... 90

CHANGE PARAMETERS / ZERO INTERLOCKS ..... 113, 147

### COMMISSIONING

ESSENTIAL pre-start checks ..... 16, 17, 41, 218

MECHANICAL ENGINEERING ..... 41

POWER ENGINEERING ..... 41

Quick start calibration ..... 42, 43

Quick start calibration step by step ..... 43

Quick start current loop AUTOTUNE ..... 43

Configurable connections ..... 161, 169

### Configurable connections

Connecting linear values with different units ..... 189

Connecting logic values with different messages ..... 189

Connecting PINS with different units ..... 169, 189

Connecting to multi-state logic parameters ..... 190

CONFIGURATION ... 134, 151, 166, 168, 171, 172, 178, 180, 183, 186, 188, 191, 193, 194, 195, 196, 199, 201, 227

CONFIGURATION / ANALOG OUTPUTS ..... 178

CONFIGURATION / BLOCK OP CONFIG ..... 134, 194

CONFIGURATION / DIGITAL IN/OUTPUTS ..... 183

CONFIGURATION / DIGITAL INPUTS ..... 180

CONFIGURATION / DIGITAL OUTPUTS ..... 186

CONFIGURATION / FIELDBUS CONFIG ..... 151, 171, 195

CONFIGURATION / JUMPER CONNECTIONS ..... 193

CONFIGURATION / SOFTWARE TERMINALS ..... 191

CONFIGURATION / STAGING POSTS ..... 171, 188

CONFIGURATION menu ..... 166, 168

CONFLICT HELP MENU ..... 149, 166, 169, 172, 201, 228

### CONFLICT HELP MENU

Multiple GOTO conflict PIN identifier ..... 201

Number of conflicts ..... 201

Conflicting GOTO connections ..... 166

### Contactors

Contactors drop out ..... 40, 87

control ..... 35, 38, 86

Drop-out delay PIN 60 ..... 89, 116, 220

Drop-out speed PIN 59 ..... 89, 220

Live delay mode PIN 58 ..... 89, 116, 220

Speed profile when stopping ..... 87

Stop ramp time PIN 56 ..... 22, 71, 88, 220

Stop time limit PIN 57 ..... 88, 220

Contactors control questions and answers ..... 35

Control terminal default functions ..... 16, 27

Control terminals ..... 29

Control terminals overview ..... 25

Crawl speed PIN 41 ..... 79, 219

### CURRENT CONTROL

4 quadrant mode enable PIN 96 ..... 105

Autotune enable PIN 92 ..... 17, 44, 100, 103, 147, 220

Block diagram ..... 97, 98, 99

Current amp integral gain PIN 94 ..... 44, 104, 220

Current amp proportional gain PIN 93 ..... 44, 104, 220

Current clamp scaler PIN 81 ..... 44, 98, 220

CURRENT OVERLOAD ..... 98

current reference PIN 91 ..... 103, 220

current reference enable PIN 97 ..... 90, 105

Discontinuous current point PIN 95 ..... 44, 103, 105, 220

Dual current clamps enable PIN 88 ..... 102, 220

I DYNAMIC PROFILE ..... 101

I DYNAMIC PROFILE / Profile current for low current limit

PIN 87 ..... 102

I DYNAMIC PROFILE / Speed break point for high current limit PIN 85.....	102	DIO1/2/3/4 OP val rectify enable PINs 272/ 278 / 284 /290 .....	184
I DYNAMIC PROFILE / Speed break point for low current limit PIN 86.....	102	DIO1/2/3/4 Output mode enable PINs 271 / 277 / 283 / 289 .....	184
Lower current clamp PIN 90 .....	103, 220	<b>DIGITAL IN/OUTPUTS / DIOX SETUP .....</b>	<b>183</b>
O/LOAD % TARGET set to 105% .....	99	<b>DIGITAL INPUTS</b>	
Overload % target PIN 82 .....	61, 99	DIP inputs for encoder signals.....	180
Overload ramp time PIN 83.....	99, 100, 220	DIP1/2/3/4 Input high value PINs 310 / 312 / 314 / 318 .....	181
overload table .....	100	DIP1/2/3/4 Input low value PINs 311 / 313 / 315 / 317 .....	181
overloads greater than 150%.....	60, 100, 141	DIP1/2/3/4 Make input value GOTO destination connection .....	181
Profile enable PIN 84 .....	101	RUN INPUT SETUP .....	182
Set current loop control terms manually .....	17, 105	RUN INPUT SETUP / Make input value GOTO destination connection .....	182
Upper current clamp PIN 89.....	103, 220	RUN INPUT SETUP / RUN input HI value PIN 318. 182, 223	
<b>DIAGNOSTIC summary windows .....</b>	<b>48</b>	RUN INPUT SETUP / RUN input LO value PIN 319 182, 223	
<b>DIAGNOSTICS .....</b>	<b>25, 43, 47, 64, 67, 68, 69, 121, 122, 125, 128, 130, 131, 133, 134, 221, 226, 233</b>	<b>DIGITAL INPUTS / DIPX SETUP .....</b>	<b>181</b>
<b>DIAGNOSTICS</b>		<b>Digital inputs and outputs .....</b>	<b>25, 30, 183, 185, 186</b>
ANALOG IO MONITOR.....	130	<b>Digital outputs .....</b>	<b>25, 26</b>
AOP1/2/3 analogue output monitor PINs 159, 160, 161 .....	130	<b>DIGITAL OUTPUTS</b>	
ARM I LOOP MONITOR.....	125	DOP1/2/3 Internal output result PINs 682/3/4.....	188
Armature bridge flag PIN 165 .....	132, 221	DOP1/2/3 Make output GET FROM source connection....	187
Armature current % monitor PIN 134 .....	126	DOP1/2/3 OP comparator threshold PINs 262 / 265 / 268 .....	187
Armature current amps monitor PIN 135 .....	126	DOP1/2/3 OP val rectify enable PINs 261 / 264 / 267 .....	187
Armature current demand monitor PIN 133 .....	126	DOP1/2/3 Output inversion enable PINs 263 / 266 / 269 .....	187
Armature volts % monitor PIN 127.....	123, 221	<b>DIGITAL OUTPUTS / DOPX SETUP.....</b>	<b>186</b>
Armature volts monitor PIN 126.....	123, 221	<b>Dimensions</b>	
Back emf % monitor PIN 128 .....	123, 221	Line reactor dimensions.....	204, 212
BLOCK OP MONITOR.....	133, 134	Mechanical dimensions PL/X 185 - 265 .....	210
Current limit flag PIN 141.....	127, 221	Mechanical dimensions PL/X 5 - 50 .....	208
Current limit monitor (lower) PIN 137 .....	126, 221	Mechanical dimensions PL/X 65 - 145 .....	209
Current limit monitor (upper) PIN 136 .....	126, 221	PL/X family cover dimensions .....	207
Current limits (prevailing upper/ lower) PINs 138 / 139 .....	127	<b>DISPLAY FUNCTIONS... 17, 47, 48, 149, 150, 153, 160, 163, 164, 168, 196, 218, 226</b>	
DC KILOWATTS MON PIN 170.....	134	<b>DISPLAY FUNCTIONS / PASSWORD CONTROL.... 17, 47, 149, 150, 153, 160, 163, 168</b>	
DIGITAL IO MONITOR.....	25, 131	<b>DRIVE PERSONALITY .....</b>	<b>196, 199</b>
DIP1 to 4 and DIO1 to 4 digital input monitor PIN 163 131, 183		<b>DRIVE PERSONALITY</b>	
DOP1 to 3 + Control IPs digital monitor PIN 164.....	132	Armature current burden resistance PIN 680 ....	42, 47, 58, 60, 104, 148, 149, 198, 199
EL1/2/3 RMS MON PIN 169 .....	69, 134	Maximum current response PIN 678 .....	21, 27, 97, 198
Encoder RPM monitor PIN 132.....	65, 124, 221	PASSIVE MOTOR SET .....	70, 196
Field active monitor PIN 147.....	129	Recipe page PIN 677 ....	17, 27, 47, 56, 58, 70, 148, 155, 157, 158, 159, 163, 164, 197
Field current % monitor PIN 144 .....	128	Recipe page block diagram .....	197
Field current amps monitor PIN 145.....	128	<b>Eeprom transfer between units .....</b>	<b>18, 21, 150, 158, 159</b>
Field demand monitor PIN 143 .....	128	<b>Encoder inputs .....</b>	<b>26</b>
Field firing angle of advance monitor PIN 146.....	108, 129	<b>ENTRY MENU .....</b>	<b>43, 47, 48, 226</b>
FLD I LOOP MONITOR .....	43, 128	<b>FIELD CONTROL</b>	
Overload limit monitor PIN 140 .....	127, 221	Block diagram .....	107
RPM monitor PIN 130 .....	124, 221	Field enable PIN 99.....	108, 220
Run flag PIN 167.....	132	Field integral gain PIN 102.....	108, 220
Running mode monitor PIN 168 .....	132	Field proportional gain PIN 101 .....	108, 220
Speed demand monitor PIN 124.....	123, 221	Field reference input PIN 114.....	112
Speed error monitor PIN 125 .....	123, 221	Field weakening derivative time constant PIN 106.....	110
Speed feedback % monitor PIN 131 .....	124, 221	Field weakening enable PIN 103.....	110
SPEED LOOP MONITOR .....	64, 122	Field weakening feedback derivative time constant PIN 107 .....	111
Speed reference monitor PIN 123.....	122	Field weakening feedback integral time constant PIN 108 .....	111
Start flag PIN 166 .....	132	Field weakening integral time constant PIN 105 .....	110
Tachogenerator volts monitor PIN 129.....	63, 124, 221	Field weakening proportional gain PIN 104 .....	110
UIP2 to 9 analogue input monitor PINs 150 to 157 .....	130	FLD WEAKENING MENU .....	17, 64, 68, 109
UIP2 to 9 digital input monitor PIN 162.....	131, 221	Minimum field current % PIN 110 .....	18, 111
<b>DIGITAL IN/OUTPUTS</b>		Quench delay PIN 113 .....	112
DIO1/2/3/4 Input high value PINs 275 / 281 / 287 / 293 .....	185	Spillover armature voltage % PIN 109.....	111
DIO1/2/3/4 Input low value PINs 276 / 282 / 288 / 294 .....	186	Standby field current PIN 112.....	112
DIO1/2/3/4 Internal output result PINs 685/6/7/8.....	186	Standby field enable PIN 111.....	112, 220
DIO1/2/3/4 Make input GOTO destination connection....	185, 186		
DIO1/2/3/4 Make output GET FROM source connection..	185		
DIO1/2/3/4 OP comp threshold PINs 273 / 279 / 285 / 290 .....	184		
DIO1/2/3/4 OP inversion PINs 274 / 280 / 286 / 291 ...	184		

Voltage output % PIN 100.....	108, 220	PIN number tables .....	21, 70, 196, 219
<b>File transfer using PL PILOT .....</b>	<b>150, 159</b>	<b>PL PILOT configuration tool .....</b>	<b>56, 160, 168</b>
<b>Full menu diagram</b>		<b>Power up windows .....</b>	<b>47</b>
(Application blocks and configuration) .....	53	<b>Product rating labels .....</b>	<b>204</b>
(Block OP and Fieldbus configs, Drive personality and Conflict Help) .....	55	<b>Product rating table .....</b>	<b>41, 146, 204</b>
(Change parameters continued) .....	50	<b>Pushbuttons for simple STOP / START (Coast to stop)...</b>	<b>31, 39</b>
(Change parameters) .....	49	<b>Pushbuttons for STOP / START (With ramp to stop)...</b>	<b>30, 39, 40</b>
(Configuration continued).....	54	<b>RAMPS</b>	
(Diagnostics) .....	51	Block diagram.....	71, 72, 73, 75
(Motor drive alarms, serial links and display functions) .....	52	Forward down time PIN 23 .....	73, 219
<b>Fuses (European stock fuses) .....</b>	<b>205</b>	Forward minimum speed PIN 27 .....	74, 219
<b>Fuses (proprietary) .....</b>	<b>205</b>	Forward up time PIN 22 .....	73, 219
<b>General requirements .....</b>	<b>25</b>	Ramp automatic preset PIN 29 .....	75
<b>GET FROM window .....</b>	<b>170</b>	Ramp external preset PIN 30 .....	75
<b>GOTO window .....</b>	<b>121, 170</b>	Ramp hold enable PIN 33.....	75, 219
<b>GOTO, GETFROM Enable.....</b>	<b>172, 201</b>	Ramp input PIN 26.....	74, 219
<b>Hidden parameters.....</b>	<b>171</b>	Ramp output monitor PIN 21.....	73, 76, 219
<b>larm output rectify enable PIN 250 .....</b>	<b>27, 178</b>	Ramp preset value PIN 31.....	75, 219
<b>Incrementing and decrementing parameter values.....</b>	<b>47</b>	Ramp S-profile % PIN 32 .....	71, 75
<b>Installation.....</b>	<b>23, 34, 215</b>	Ramping flag PIN 35 .....	73, 76, 94, 95, 219
<b>Installation</b>		Ramping threshold PIN 34 .....	76
3-phase power supply port .....	215	Reverse down time PIN 25.....	73, 219
AC supply to L1/2/3 different to EL1/2/3. 37, 107, 108, 213		Reverse minimum speed PIN 28 .....	74, 219
Earthing and screening guidelines .....	18, 215	Reverse up time PIN 24 .....	73, 219
Earthing diagram for typical installation .....	216	<b>Record of bug fixes.....</b>	<b>234</b>
Guidelines when using filters.....	18, 217	<b>Record of modifications.....</b>	<b>48, 233</b>
Mounting PL/X 185 - 265 .....	210	<b>Reduced menu enable .....</b>	<b>163, 196</b>
Mounting PL/X 5 - 50.....	208	<b>Regenerative stopping with PL models .....</b>	<b>22, 88</b>
Mounting PL/X 65 - 145 .....	209	<b>Remotely mounted display unit.....</b>	<b>21, 48, 159, 160, 164, 218</b>
Terminal tightening torques.....	41, 208, 209, 210, 214	<b>Restoring the drive parameters to the default condition .</b>	<b>17, 27,</b>
Venting models PL/X 185 - 265 using back panel aperture		<b>47, 58, 70, 163, 196</b>	
.....	211	<b>Risks .....</b>	<b>15, 218</b>
Venting models PL/X 185 - 265 using standoff pillars ....	211	<b>SELF TEST MESSAGE .....</b>	<b>18, 32, 148, 149, 150, 156, 159</b>
Wiring instructions.....	213	<b>SELF TEST MESSAGE</b>	
<b>Installation guide for EMC.....</b>	<b>215</b>	Authorisation needed .....	149
<b>Introduction .....</b>	<b>20</b>	Data corruption .....	18, 148, 156
<b>JOG CRAWL SLACK / Block diagram .....</b>	<b>78</b>	Disable GOTO, GETFROM.....	148
<b>Jog mode select PIN 42 .....</b>	<b>30, 77, 80, 219</b>	Enable GOTO, GETFROM.....	149
<b>Jog speed 1 / 2 PINs 37 / 38.....</b>	<b>79</b>	Enter password .....	149
<b>Jog/Slack ramp PIN 43.....</b>	<b>71, 80</b>	GOTO CONFLICT .....	149
<b>JUMPER connections .....</b>	<b>171, 193</b>	Integral armature current cal fail .....	148
<b>JUMPER CONNECTIONS</b>		Internal error code.....	32, 149
Make jumper GET FROM source connection.....	193	Memory version error .....	150, 159
Make jumper GOTO destination connection .....	193	Memory write error .....	150
<b>Key functions.....</b>	<b>46</b>	Proportional armature current cal fail.....	148
<b>Language select .....</b>	<b>164</b>	Self cal tolerance .....	148
<b>Main contactor isolating AC stack and auxiliary supplies .....</b>	<b>37</b>	Stop drive to adjust parameter .....	149
<b>Main contactor isolating AC stack supply .....</b>	<b>37</b>	<b>Semiconductor fuse ratings .....</b>	<b>18, 41, 204</b>
<b>Main contactor isolating DC armature .....</b>	<b>16, 38</b>	<b>SERIAL LINKS</b>	
<b>Main Contactor operation .....</b>	<b>16, 35, 43</b>	Drive transmit .....	56, 154, 158
<b>Main contactor wiring options.....</b>	<b>34, 37, 88, 213, 214</b>	PARAMETER EXCHANGE / Drive receive .....	156, 158
<b>Maintenance, Changing control or power cards.....</b>	<b>159, 200</b>	PARAMETER EXCHANGE / Drive to drive .....	153, 158
<b>Menu list .....</b>	<b>226</b>	PARAMETER EXCHANGE / menu list to host .....	157
<b>Mode of operation .....</b>	<b>20</b>	parameter exchange rules relating to software version ..	150,
<b>Model current rating</b>		154, 156, 158, 159, 164	
50% / 100% rating select .....	44, 149, 199	Parameter exchange using ASCII COMMS .....	56, 160, 168
changing BURDEN OHMS .....	18, 200	PARAMETER EXCHANGE with a locked recipe page 3 .	149,
135		155	
<b>MOTORISED POT RAMP</b>		PL PILOT and SCADA.....	150, 160, 168
Block diagram .....	82	Receiving parameter data file from a PC .....	156
MP Maximum / minimum clamps PINs 50 / 51 .....	83	Reference exchange master GET FROM.....	162
MP memory boot up PIN 54.....	84	Reference exchange master monitor PIN 192.....	162
MP output monitor PIN 45 .....	82	Reference exchange slave monitor PIN 191 .....	162
MP preset PIN 52 .....	83	Reference exchange slave ratio PIN 189.....	162
MP Preset value PIN 53.....	84, 219	Reference exchange slave sign PIN 190 .....	162
MP Up / Down command PINs 48 / 49.....	83	RS232 PORT1 / Connection pinouts.....	18, 153, 154, 156,
MP Up / Down time PINs 46 / 47 .....	82	157, 161	
<b>Numeric tables .....</b>	<b>219</b>	RS232 PORT1 / PARAMETER EXCHANGE.....	18, 154
<b>Overview of features .....</b>	<b>21</b>	RS232 PORT1 / Port1 Baud rate PIN 187 ....	153, 158, 222
<b>PASSWORD CONTROL</b>		RS232 PORT1 / Port1 function PIN 188 .....	153
Alter password .....	164	RS232 PORT1 / PORT1 REF EXCHANGE.....	140, 161
Enter password .....	164	Transmitting a menu list to a PC.....	157
		Transmitting SERIAL LINKS	

parameter data file to a PC .....	154, 155, 156, 157
USB ports .....	153, 160, 168, 233
<b>Signal test pins .....</b>	<b>27, 105</b>
<b>Slack speed 1 / 2 PINs 39 / 40 .....</b>	<b>79</b>
<b>Small test motors .....</b>	<b>44, 70, 199</b>
<b>SOFTWARE TERMINALS</b>	
Anded jog PIN 306 .....	191, 223
Anded run PIN 305 .....	191, 223
Anded start PIN 307 .....	192, 223
Internal run input PIN 308 .....	182, 192
<b>Software version .....</b>	<b>48, 164</b>
<b>Software version number of the unit. ....</b>	<b>21, 48, 168</b>
<b>Speed / current reference 3 monitor PIN 64 .....</b>	<b>220</b>
<b>SPEED CONTROL</b>	
Block diagram .....	27, 85, 93, 105
High break point PIN 75 .....	95, 220
Integral % during ramp PIN 78 .....	76, 95, 220
Low break point PIN 74 .....	95, 220
Low breakpoint integral time constant PIN 77 .....	95
Low breakpoint proportional gain PIN 76 .....	95
Max negative speed reference PIN 70 .....	93
Max positive speed reference PIN 69 .....	93
Speed integral reset enable PIN 73 .....	94
Speed integral time constant PIN 72 .....	94, 220
Speed loop adaption enable PIN 79 .....	92, 96
Speed proportional gain PIN 71 .....	17, 44, 64, 65, 92, 93, 220
<b>SPEED CONTROL / SPEED PI ADAPTION .....</b>	<b>94</b>
<b>SPEED REF SUMMER / Block diagram .....</b>	<b>90</b>
<b>Speed reference (Ramped) 4 PIN 65 .....</b>	<b>91, 220</b>
<b>Speed reference 1 PIN 62 .....</b>	<b>82, 91, 220</b>
<b>Speed reference 2 PIN 63 .....</b>	<b>91, 220</b>
<b>Speed/Current Reference 3 ratio PIN 67 .....</b>	<b>92</b>
<b>Speed/Current Reference 3 sign PIN 66 .....</b>	<b>91</b>
<b>SPINDLE ORIENTATE</b>	
Block diagram .....	117
Marker enable PIN 240 .....	118, 222
Marker frequency monitor PIN 243 .....	120, 222
Marker offset PIN 241 .....	119, 222
Marker specification .....	118
position flag PIN 244 .....	120, 222
Position reference PIN 242 .....	120, 222
Spindle orientate operation .....	117
Zero speed lock PIN 122 .....	118, 220
<b>STAGING POSTS / Digital / analog 1/2/3/4 PINs 296 to 303 .....</b>	<b>190</b>
<b>STOP MODE RAMP</b>	
Block diagram .....	85
<b>Supply loss shutdown .....</b>	<b>31, 32, 69, 145, 149</b>
<b>Supply voltages required for all models .....</b>	<b>22</b>

#### PIN number tables

The description of every parameter can be located by using the tables in chapter 15. They are listed in numeric order under convenient headings. The tables contain a cross reference to each parameter paragraph.

<b>Technical Data .....</b>	<b>22, 105</b>
<b>Tips for using the manual .....</b>	<b>21</b>
<b>TRIP MESSAGE</b>	
Armature overcurrent .....	143
Armature overvolts .....	143
Autotune quit .....	103, 147
Bad reference exchange .....	146, 161
Cannot autotune .....	103, 147
Contactork lock out .....	146, 147
Field loss .....	144
Field overcurrent .....	143
Heatsink overtemp .....	146
Missing pulse .....	145
Overspeed .....	140, 144
Short circuit digital outputs .....	25, 146
Speed feedback mismatch .....	145
Stall trip .....	145
Supply phase loss .....	32, 47, 69, 145, 214
Synchronization loss .....	146, 214
Thermistor on T30 .....	144
User trip .....	144
<b>UL, cUL .....</b>	<b>217</b>
<b>UNIVERSAL INPUTS</b>	
4-20mA loop input SETUP .....	27, 175
Analog GOTO destination connection .....	176
Block diagram .....	174
Digital input, high value for output 1 PIN 3(2)5 to 3(9)5 .....	177
Digital input, high value for output 2 PIN 3(2)7 to 3(9)7 .....	177
Digital input, low value for output 1 PIN 3(2)6 to 3(9)6 .....	177
Digital input, low value for output 2 PIN 3(2)8 to 3(9)8 .....	177
Digital output 1 GOTO destination connection .....	176
Digital output 2 GOTO destination connection .....	176
Input offset PIN 3(2)1 to 3(9)1 .....	174
Input range PIN 3(2)0 to 3(9)0 .....	174
Linear scaling ratio PIN 3(2)2 to 3(9)2 .....	175
Maximum clamp level PIN 3(2)3 to 3(9)3 .....	175
Minimum clamp level PIN 3(2)4 to 3(9)4 .....	175
Threshold PIN 3(2)9 to 3(9)9 .....	177
<b>Warnings .....</b>	<b>13, 16, 218</b>
<b>ZERO INTERLOCKS</b>	
Block diagram .....	114
SPINDLE ORIENTATE .....	64, 65, 66, 89, 114, 116
Standstill enable PIN 115 .....	114, 220
standstill flag PIN 121 .....	115, 220
Zero interlocks current level PIN 118 .....	115, 220
Zero interlocks speed level PIN 117 .....	114, 220
zero reference flag PIN 119 .....	115, 220
Zero reference start enable PIN 116 .....	114, 220
zero speed flag PIN 120 .....	115, 220



## 16.1 Record of modifications

Manual Version	Description of change	Reason for change	Paragraph reference	Date	Software version
2.03	Refer to supplier				
3.01	Refer to supplier			April 2000	3.01
4.00	Add new sub-menu for spindle orientation	Improved functionality	6.10.9	Aug 00	4.01
4.00	Add new sub-menu for PORT 1 COMMS LINK	Improved functionality	10.1.4.7	Aug 00	4.01
4.00	Add description of new burden resistor switch	Improved functionality	13.13.3.1	Aug 00	4.01
4.00	Add new apps blocks Comparators 1 - 4 Add new apps blocks C/O switch 1 - 4	Improved functionality	Apps manual	Aug 2000	4.01
4.00	Man typo. Terminal 23 DOP2 should be Ramping flag, Running mode mon numerical codes incorrect, now OK	Previous manuals say At standstill is on T23	Various	Sept 2000	N/A
4.02	Lowest value for 2)RATED ARM AMPS changed from 20% to 33% (Range was 5 - 1 now 3 - 1)	Values below 33% have inferior transient response. 50%/100% burden value switch added to power board extends range to 6 - 1	6.1.2 13.3.3	Nov 2000	4.02
4.03	677)RECIPE PAGE function added	Allows 3 total drive recipes to be utilised	13.13.2	Feb 2001	4.03
4.03	REFERENCE EXCHANGE now able to receive and re-transmit simultaneously.	Improved functionality allowing cascading of digitally locked multiple units.	10.3	Feb 2001	4.03
4.03	171)SPEED TRIP ENABLE	Automatic switch to AVF function added	8.1.1	Feb 01	4.03
4.03	UIP / AOP / DIP / DIO / DOP set up windows	Function terminal number included in display		Feb 01	4.03
4.03	100)FIELD VOLTS OP % 4-Key reset does not affect this parameter. Or corresponding value of PASSIVE MOTOR SET.	Improved functionality. Protects user from accidental field over-voltage by retaining set value after restoring 4-KEY reset defaults.	6.9.3	Feb 2001	4.03
4.05	Extra information about contactor control Prime warnings in manual summarised in one section How to use USB ports Further information about PL PILOT Data corruption message for each recipe page  Change push button control diagram + add new one. Add hidden PIN 714)IN SLACK FLAG. Make 3)CURRENT LIMIT% adjustable whilst running New DIAGNOSTICS PIN 132)ENCODER RPM MON. Change name of hidden PIN 709 from ENCODER RPM% to MOTOR RPM %. Function unchanged.  Max I <sup>2</sup> t rating for main PL/X 65 and 85 fuses changed	Incorrect contactor control by users is main mode of failure. Improve warning presentation Some computers only have USB ports. PL PILOT upgraded to implement multidrop. After message, left key returns to the RAM data prevailing prior to parameter exchange. Previous diagram did not latch STOP. Useful for controlling tension enable. Users request. Users request. Assist encoder commissioning. To emphasize that this PIN 709 is scaled by PIN 12)MOT/ENC SPD RATIO and its 100% level is determined by 6)DESIRED MAX RPM Change in spec from device manufacturers	4 2.4 10.1.4 10.2.5.1 9.1.1  4.3.4/5 6.3 6.1.3 7.1.9 6.1.10.3  14.1, 14.3	July 2001	4.05
5.01	PORT1 FUNCTION no longer subject to password	Improved functionality	11.2, 10.1	Mar 02	5.01
5.01	Fieldbus based comms facility added sub-menu in CONFIG menu. Uses 16 GOTOs and 16 GETFROMS	Improved functionality. Requires mounting board and PROFIBUS card	Serial Comms Manual	Mar 02	5.01
5.01	Range of 18)RATED ARM VOLTS and 19)EL1/2/3 RATED AC and their monitors increased to 1000V.	Improved functionality	6.1	Mar 02	5.01
5.01	Field fail threshold for non field weakening mode of operation raised from 5% to 20%.	Improved functionality. 5% was sometimes too low to ensure trip for small field.	8.1.3	Mar 02	5.01
5.01	20)MOTOR 1, 2 SELECT. Parameters subjected to 'STOP DRIVE TO ADJUST' status now only transposed during stop sequence	Improved functionality.	6.1.17	Mar 02	5.01
5.01	64)SPEED/CUR REF 3 removed from GOTO selection.	This PIN 64 is not able to be a GOTO target because it is internally connected to UIP3	13.3	Mar 02	5.01
5.01	50% / 100% burden selection may be by switch or jumper. The jumper will progressively become the sole method on all models.	Improved functionality. The jumper provides small motor burden when parked on one pin:- PL/X (5 - 50 = 6A) (65 - 265 = 24A)	13.13.4.1	Mar 02	5.01
5.01	Inverse time armature current overload algorithm.	Improved functionality. Algorithm now uses better precision maths to improve accuracy.	6.8.3.1	Mar 02	5.01
5.02	Enhanced Fieldbus functionality 64)SPEED/CUR REF 3 changed to 64)SPD/CUR REF 3 MON	See version 5.02 Serial Comms manual To reflect the fact that this PIN is internally connected to UIP3 T3 and hence display is a monitor. Also removed from GOTO choices.	13.3	July 02	5.02
5.02	French language added to version 5.02 software.	Improved functionality.	11.3	July 02	5.02
5.12	Software for future Ethernet options added. Tacho input min range limit lowered. Option now available to drive high inductance loads.	Improved functionality. Improved functionality. Allows high powered fields to be driven by armature output. (Factory enabled function).	3.4.4	Nov 02	5.11
5.12	Default % Diagnostic summary windows added	Improved functionality.	5.1.6	Jan 03	5.12
5.12	8)ANALOG TACHO VOLTS changed to 8)MAX TACHO VOLTS	Improved functionality, more descriptive of actual function.	6.1.8	Jan 03	5.12
5.14	Addition of index Allow 2)RATED ARM AMPS and 4)RATED FIELD AMPS to be written to by Driveweb ethernet system. Remove 1 second filter from standstill logic. Allow 122)ZERO SPEED LOCK alteration during run. Improve stall trip for resistive load applications.	Improve manual Improved functionality.  Improved functionality. Improved functionality. Improved functionality.	16 6.1  6.10.2 6.10.2 8.1.8	Sep 04	5.14

## 16.2 Record of bug fixes

See Apps manual for bug fixes relevant to applications blocks topics.

Manual Version	Function with Bug	Comments	Paragraph reference	Date	Software version
2.03	Refer to supplier				2.XX
3.01	Refer to supplier				
4.00	No bugs recorded in main drive blocks			Sept 2000	4.01
4.03	JOG/SLACK RAMP 67)SPD/CUR RF3 RATIO	Did not unlatch at the end of SLACK operation. Now OK Did not scale correctly. Now OK	6.3.6 6.6.7	Feb 2001	4.03
4.05	No bugs recorded in main drive blocks		July 2001		4.04 4.05
5.01	DATA CORRUPTION possible if control supply removed during active ASCII COMMS transmission.	This was possible when using PL PILOT if PILOT left running and control supply removed. Now OK.	9.1.1	Mar 2002	5.01
5.01	DOP3 gives unwanted low to high transitions if ASCII COMMS active.	DOP3 is default output of DRIVE HEALTHY FLAG so is normally high, and causes trip on first low, which masks bug. Bug was more of a nuisance if DOP3 re-configured for new task which requires normally low output AND ASCII COMMS was active. Now OK.	13.7	Mar 2002	5.01
5.02	No bugs recorded in main drive blocks			July 02	5.02
5.12	No bugs recorded in main drive blocks			Jan 03	5.12
5.14	UIP3 malfunction when 8)MAX TACHO VOLTS set below +/-30V. SUMMER1 and SUMMER2 subtotals description in manual and GETFROM list transposed. 64)SPD/CUR REF 3 MON changed to 64)SPEED REF 3 MON. 18)RATED ARM VOLTS feedback scaling assumes value of 160V internally for entered values below 160V. 126)ARM VOLTS MON assumed entered value.	Now OK.  Now OK. Still transposed in PL pilot version up to 4.05  Monitoring function inhibited in speed bypass mode.  Now OK.	13.3.1  Apps man. 6.6.4 6.1.15	Sep 04	5.14

## 17 Changes to product since manual publication

Any new features that affect the existing functioning of the unit, that have occurred since the publication of the manual, will be recorded here using an attached page.

# 1 Default Block Diagram

PLBLK514 (Sep 2004)

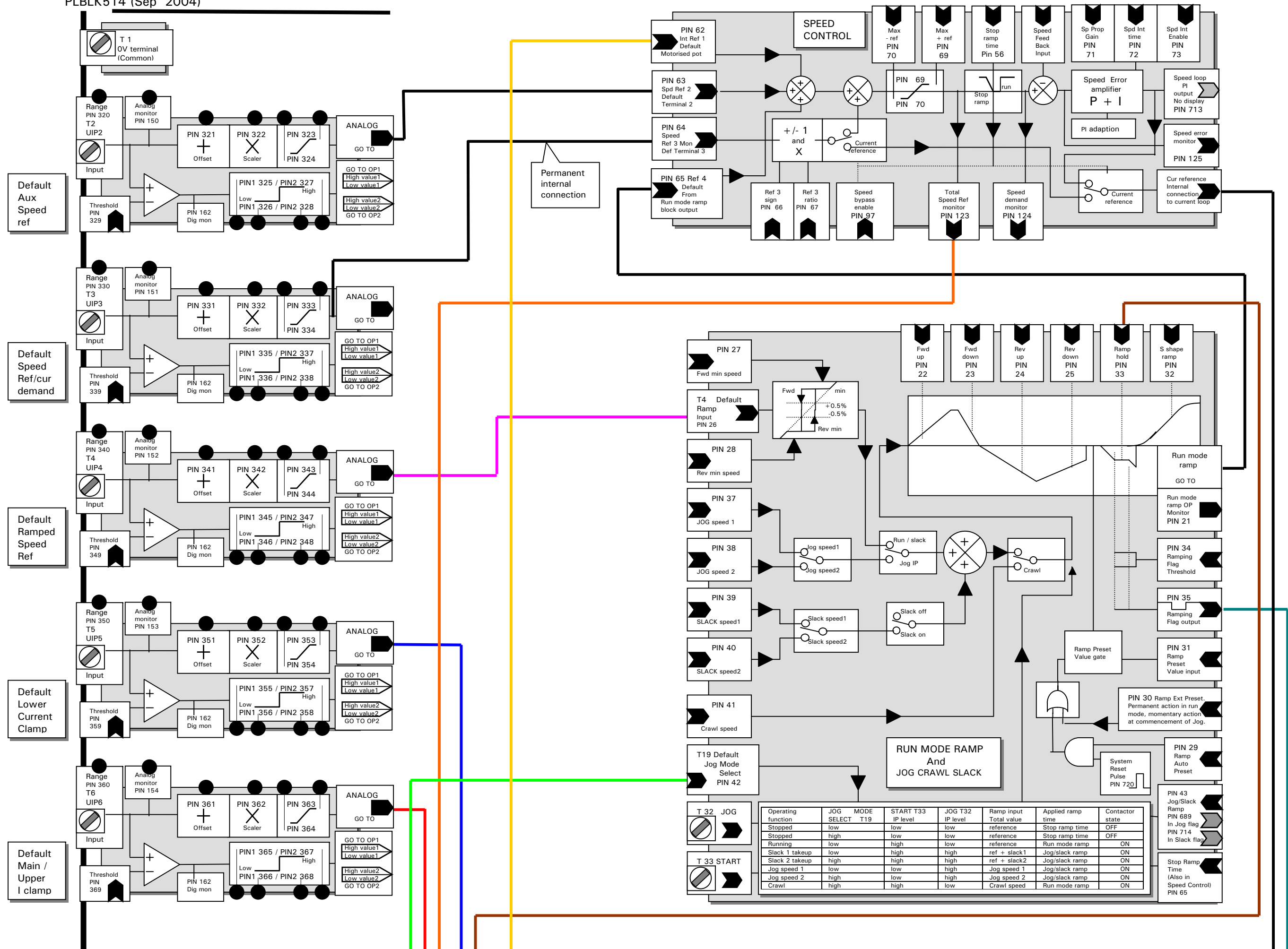

Operating function	JOG MODE SELECT T19	START T33 IP level	JOG T32 IP level	Ramp input Total value	Applied ramp time	Contact state
Stopped	low	low	low	reference	Stop ramp time	OFF
Stopped	high	low	low	reference	Stop ramp time	OFF
Running	low	high	low	reference	Run mode ramp	ON
Slack 1 takeup	low	high	high	ref + slack1	Jog/slack ramp	ON
Slack 2 takeup	high	high	high	ref + slack2	Jog/slack ramp	ON
Jog speed 1	low	low	high	Jog speed 1	Jog/slack ramp	ON
Jog speed 2	high	low	high	Jog speed 2	Jog/slack ramp	ON
Crawl	high	high	low	Crawl speed	Run mode ramp	ON

# Default block diagram

2

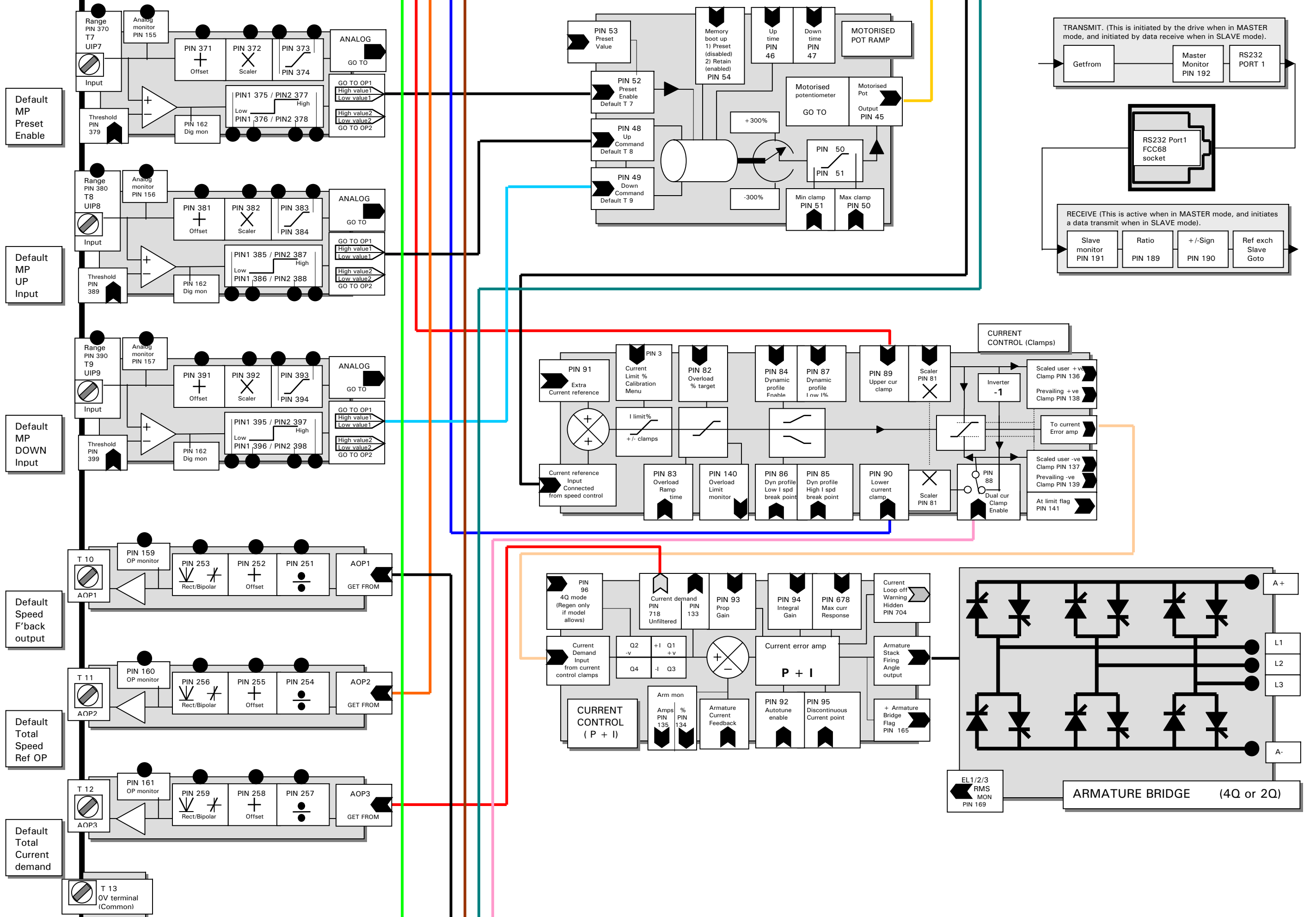

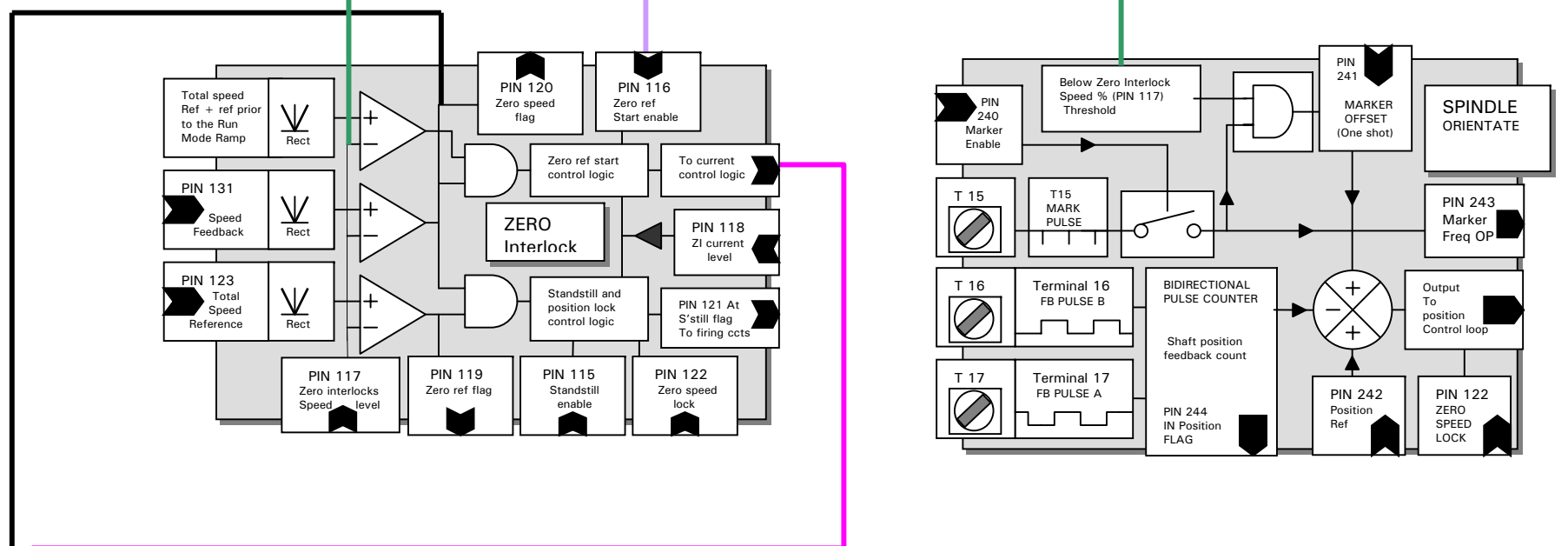
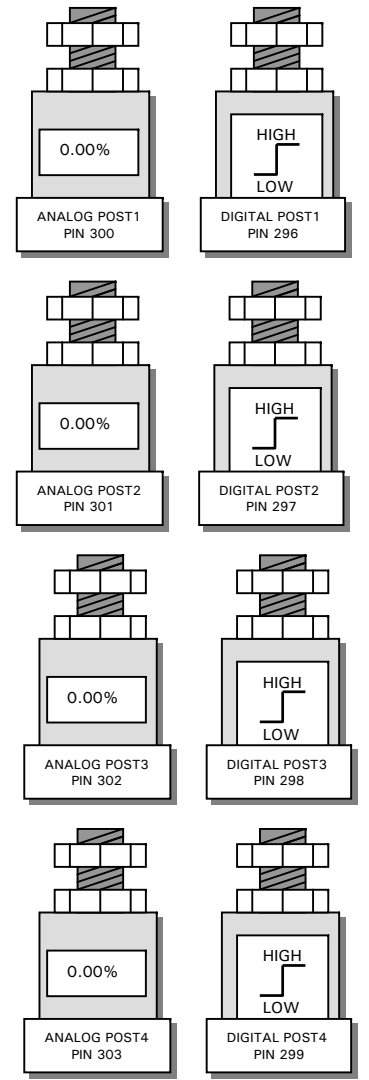
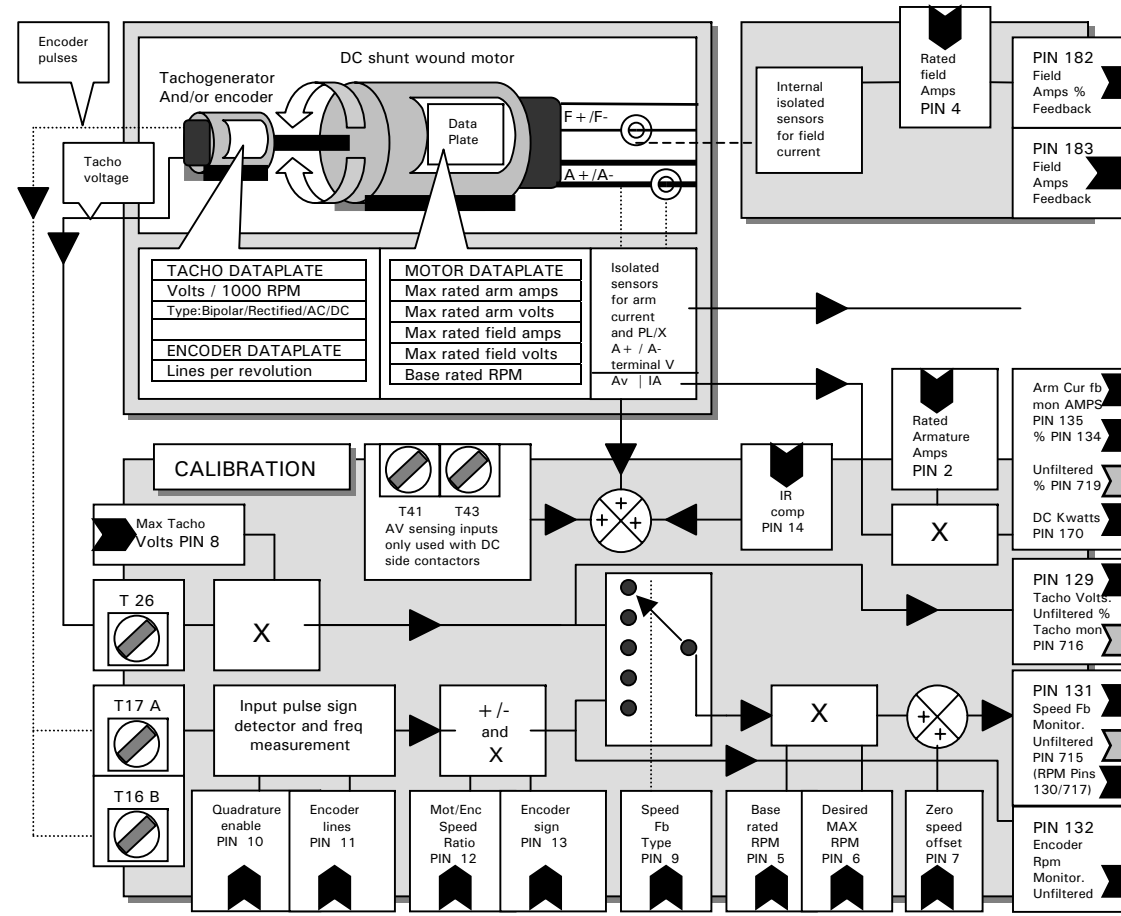
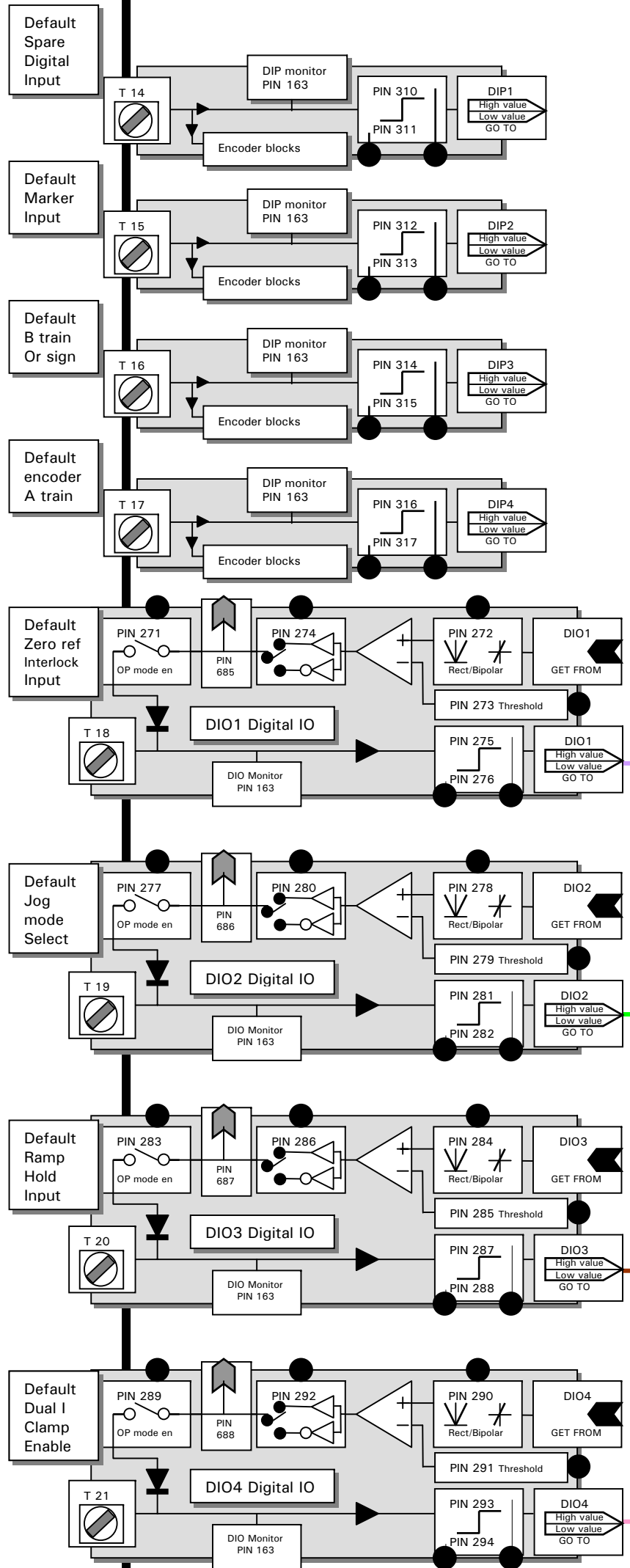

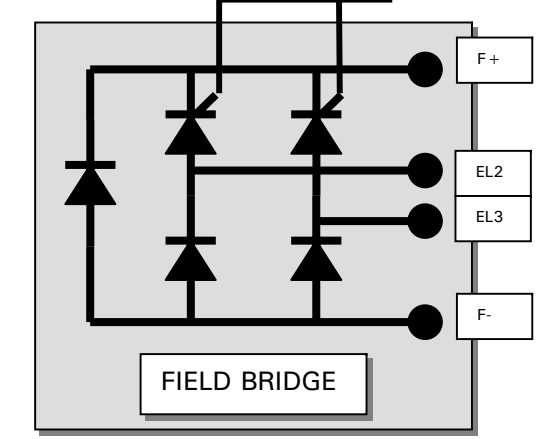
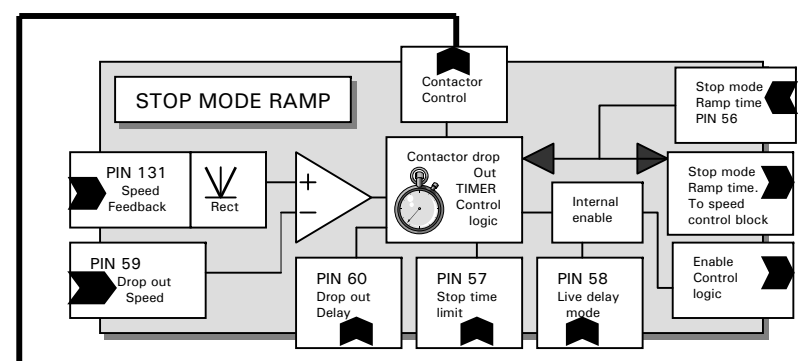
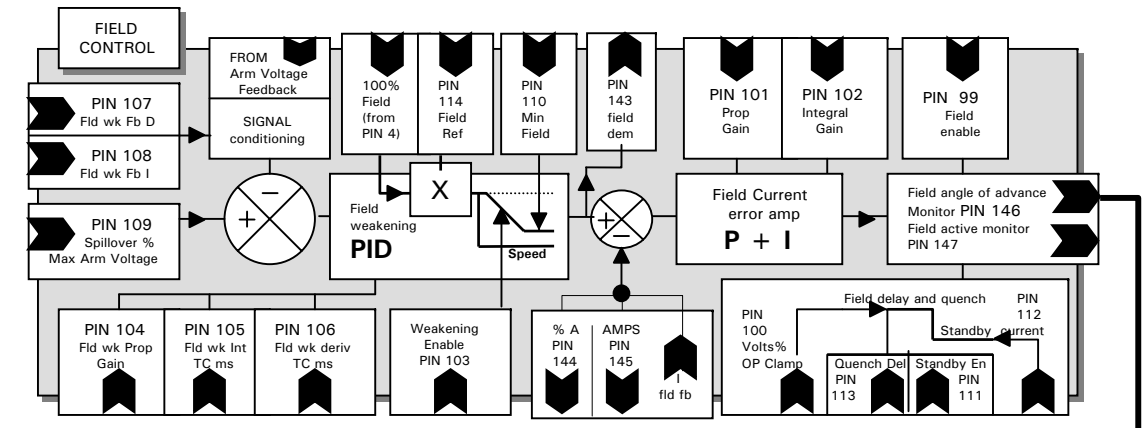
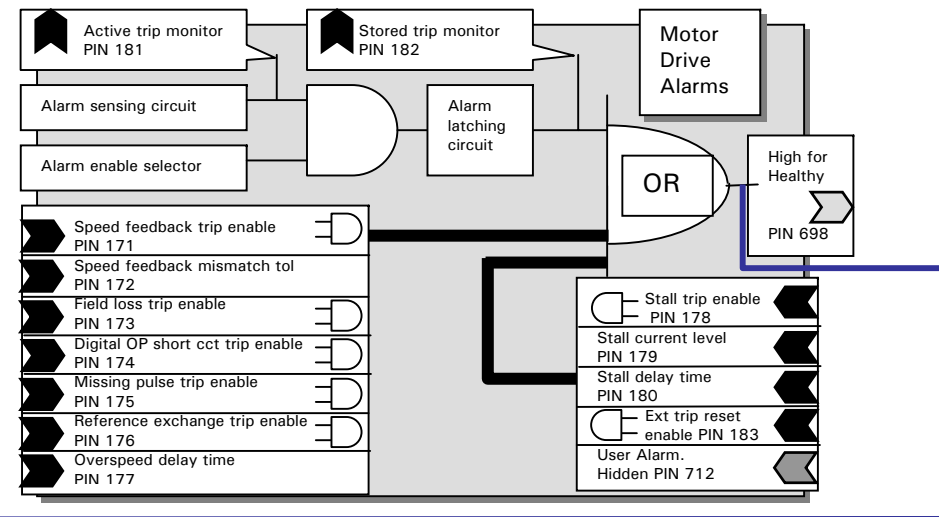
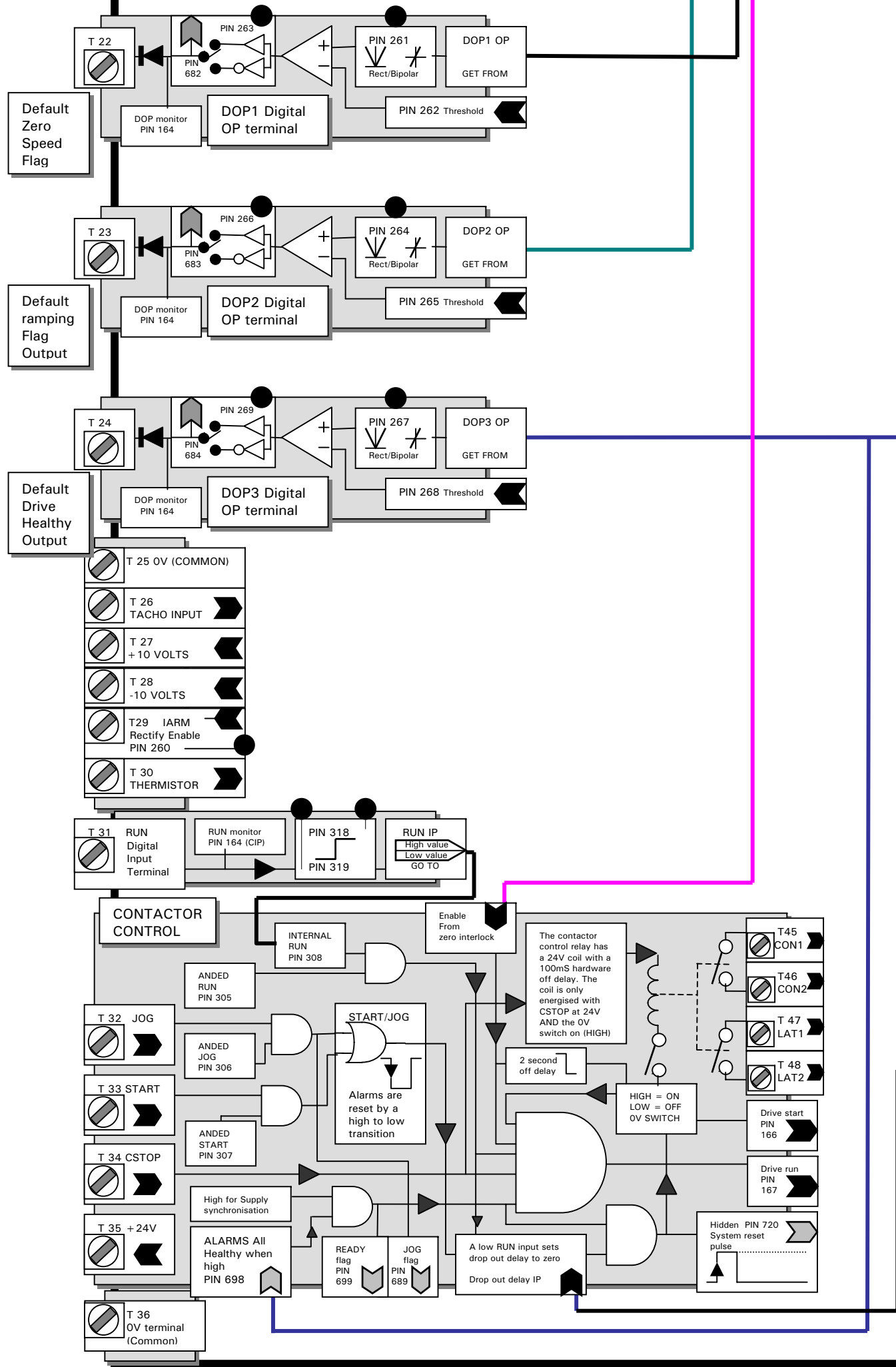

**Sprint Electric Limited**  
**Arundel, UK**

**Tel.           + 44 (0)1903 730000**  
**Fax.           + 44 (0)1903 730893**  
**Email.        info@sprint-electric.com**

**[www.sprint-electric.com](http://www.sprint-electric.com)**