

A	B	C	D	E	F	G	H	I	L
---	---	---	---	---	---	---	---	---	---

ESTRUSORE A Ø120

IMPIANTO FILM 3 STRATI

CLIENTE : LARIO MACHIERY
 ORDINE : 026/05/2001
 COMM. : 065 -- 065.A
 DATA : 16/05/2001

400V 3F + N 50Hz

SCHEMA ELETTRICO
 MORSETTIERE DI COLLEGAMENTO
 LAYOUT QUADRI
 LISTA MATERIALE



DIS. N.	MACCHINA/DESCRIZIONE: ESTRUSORE A / IMPIANTO FILM 3 STRATI	ORDINE: 2001	FOGLIO AA
N. FILE	C.G. SISTEMI s.n.c. V. G. Cantore N°10 Tel. 0331 733197 Fax. 0331 264077	COMMESSA: 065.A	SEGUE A
POS. ARCH.	DATA: 16/05/2001 email. c.g.sistemi@libero.it CARDANO AL CAMPO (VA) ITALY	ESEGUITO: G.B.	

A	B	C	D	E	F	G	H	I	L
---	---	---	---	---	---	---	---	---	---

LARIO MACHINERY

<http://www.lariomachinery.it>

E-mail: lario@working.it



DIS. N.	MACCHINA/DESCRIZIONE: ESTRUSORE A / IMPIANTO FILM 3 STRATI	ORDINE: 2001	FOGLIO A
N. FILE	C.G. SISTEMI s.n.c. V. G. Cantore N°10 Tel. 0331 733197 Fax. 0331 264077	COMMESSA: 065.A	SEGUE B
POS. ARCH.	DATA: 16/05/2001 email. c.g.sistemi@libero.it CARDANO AL CAMPO (VA) ITALY	ESEGUITO: G.B.	

Lario Machinery s.r.l.

Tel. 0331 832120 Fax. 0331 832173

V. Piccinelli N°5/B

MOZZATE (CO) 22076 ITALY

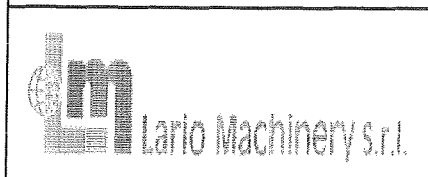

DIS. N.	MACCHINA/DESCRIZIONE: ESTRUSORE A / IMPIANTO FILM 3 STRATI			ORDINE: 2001	FOGLIO B
N. FILE	C.G. SISTEMI s.n.c.	V. G. Cantore N°10	Tel. 0331 733197 Fax. 0331 264077	COMMESSA: 065.A	SEGUE C
POS. ARCH.	DATA: 16/05/2001	email. c.g.sistemi@libero.it	CARDANO AL CAMPO (VA) ITALY	ESEGUITO: G.B.	

A	B	C	D	E	F	G	H	I	L
---	---	---	---	---	---	---	---	---	---

C.G. SISTEMI s.n.c.

Tel. 0331 733197 Fax. 0331 264077

E-mail: c.g.sistemi@libero.it

V. G. Cantore N°10

CARDANO AL CAMPO (VA) ITALY

E' vietata la riproduzione e la divulgazione del presente hardware e software senza il permesso o accordo scritto da : C.G. SISTEMI s.n.c.
La societa' si riserva di tutelare i propri diritti a termine di legge.

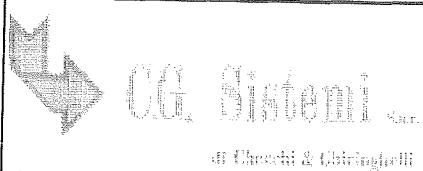

DIS. N.	MACCHINA/DESCRIZIONE:	ESTRUSORE A / IMPIANTO FILM 3 STRATI	ORDINE: 2001	FOGLIO C
N. FILE	C.G. SISTEMI s.n.c. V. G. Cantore N°10	Tel. 0331 733197 Fax. 0331 264077	COMMESSA: 065.A	SEGUE 1
POS. ARCH.	DATA: 16/05/2001 email. c.g.sistemi@libero.it	CARDANO AL CAMPO (VA) ITALY	ESEGUITO: G.B.	

A

B

C

D

E

F

G

H

I

L

COLORAZIONE CAVI			SEZIONE CAVI	
LINEE	TENSIONE	COLORE	SEZIONE	PORTATA
POTENZA C.C.	-	NERO	1.5	6A
POTENZA C.A.	400V	NERO	2.5	10A
AUSILIARI C.C.	24V	BLU	4	16A
AUSILIARI C.A.	110V	ROSSO	6	24A
			10	40A
			16	64A
TERRA	0V	GIALLO-VERDE	25	100A
NEUTRO	0V	BLU	35	140A
			50	200A
			70	140A
			95	190A
			120	240A

NORME DI COSTRUZIONI C.E.I. - I.E.C.

SIMBOLOGIA DEGLI SCHEMI A NORME DIN 40710 - 714



C.G. Sistemi S.p.A.

di Cherchi & Chiringelli

DIS. N.

MACCHINA/DESCRIZIONE:

DIMENSIONAMENTO CAVI - COLORAZIONE CAVI

ORDINE: **2001**

FOGLIO A

N. FILE

C.G. SISTEMI S.n.C.

V. G. Cantore N°10

Tel. 0331 733197

Fax. 0331 264077

COMMESSA: **065.A**

POS. ARCH.

DATA: 16/05/2001

email. c.g.sistemi@libero.it

CARDANO AL CAMPO (VA) ITALY

ESEGUITO: **G.B.**

SEGUE B

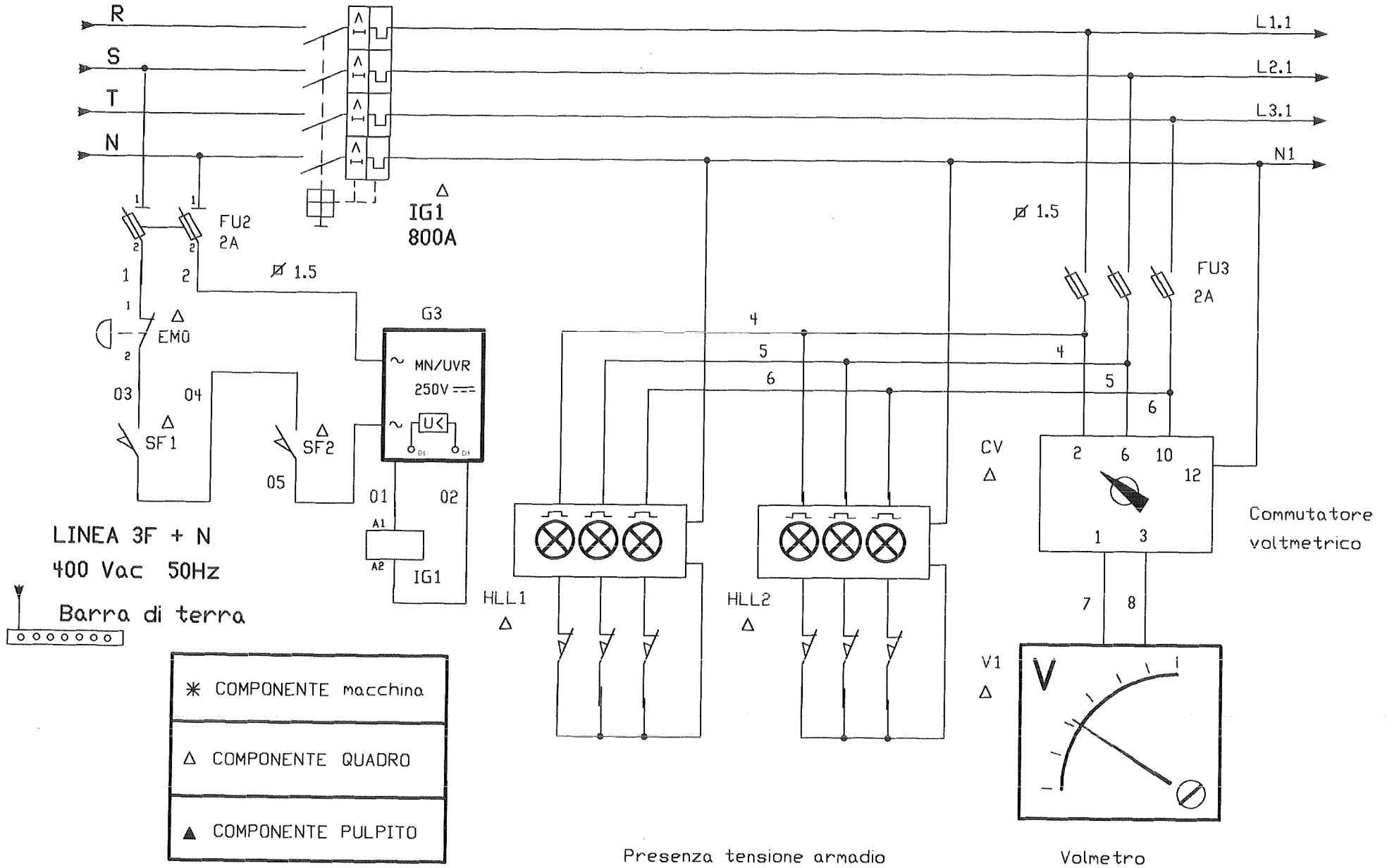

DIS. N.	MACCHINA/DESCRIZIONE: Inserzione Linea - Presenza tensione			ORDINE: 2001	FOGLIO 1
N. FILE	C.G. SISTEMI s.n.c. V. G. Cantore N°10 Tel. 0331 733197 Fax. 0331 264077			COMMESSA: 065.A	SEGUE 2
POS. ARCH.	DATA: 16/05/2001	email. c.g.sistemi@libero.it	CARDANO AL CAMPO (VA) ITALY	ESEGUITO: G.B.	

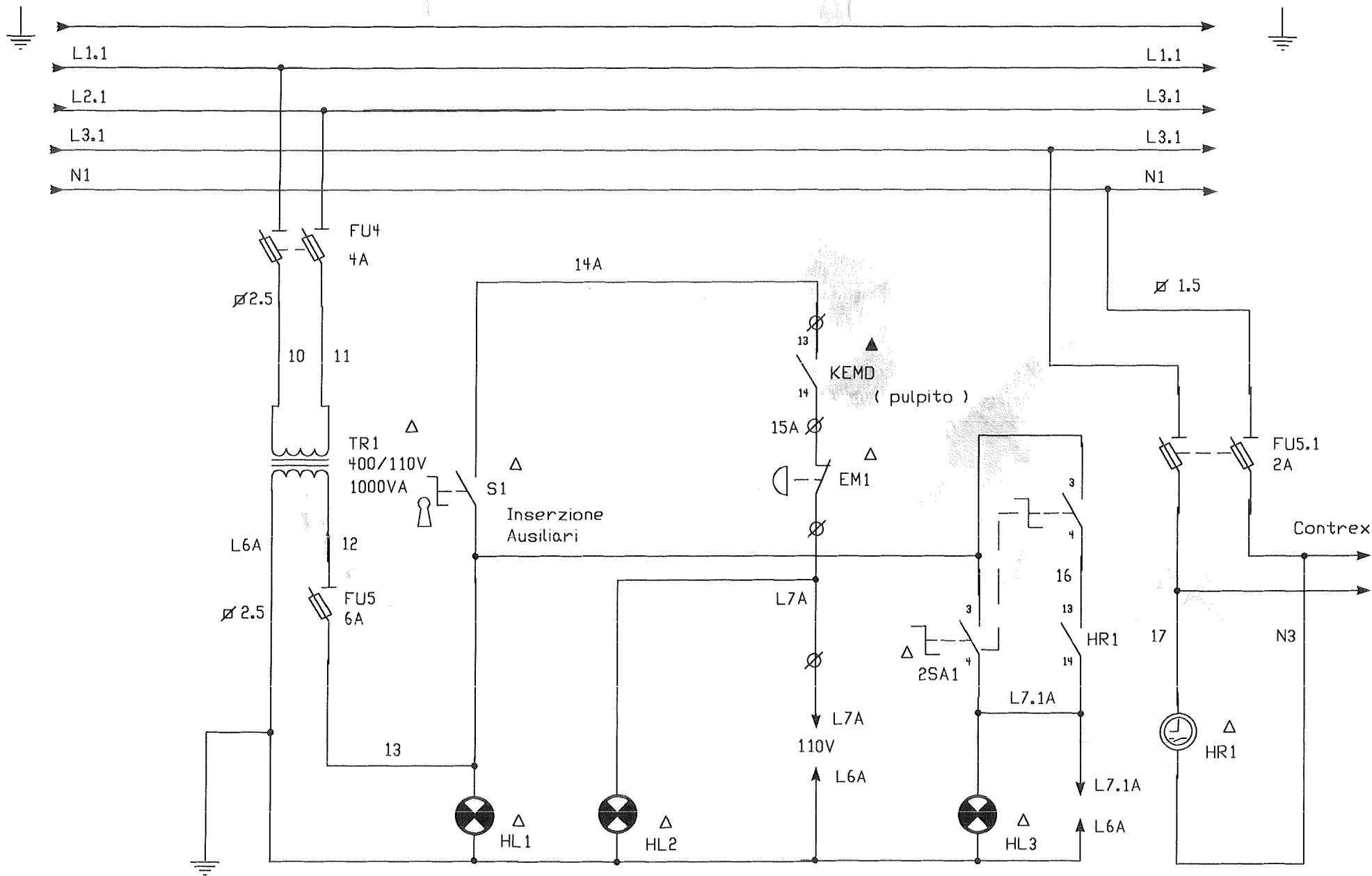

Presenza
tensione

Ausiliari
inseriti

Termoregolazione
inserita

Orologio
inserzione
termoregolazione



DIS. N.	MACCHINA/DESCRIZIONE: Ausiliari			ORDINE: 2001	FOGLIO 2
N. FILE	C.G. SISTEMI s.n.c. V. G. Cantore N°10 Tel. 0331 733197 Fax. 0331 264077			COMMESSA: 065.A	SEGUE 3
POS. ARCH.	DATA: 16/05/2001	email. c.g.sistemi@libero.it	CARDANO AL CAMPO (VA) ITALY	ESEGUITO: G.B.	

30

31

32

33

34

35

36

37

38

39

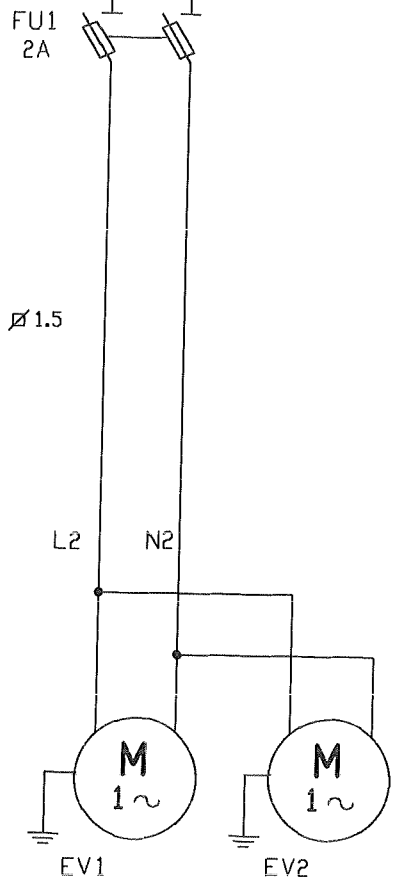
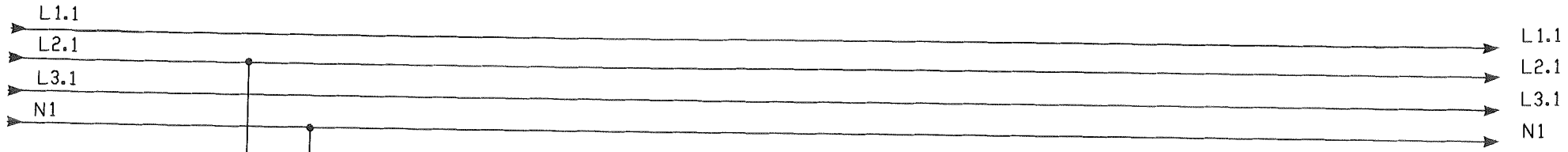

VENTILATORI ARMADIO
28/29W 220/230VAC

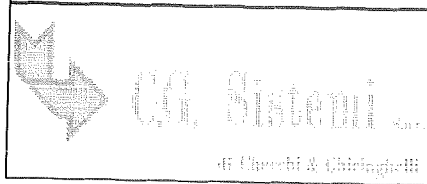

DIS. N.	MACCHINA/DESCRIZIONE: VENTILAZIONE QUADRI			ORDINE: 2001	FOGLIO 3
N. FILE	C.G. SISTEMI s.n.c.	V. G. Cantore N°10	Tel. 0331 733197	Fax. 0331 264077	COMMESSA: 065.A
POS. ARCH.	DATA: 16/05/2001	email. c.g.sistemi@libero.it	CARDANO AL CAMPO (VA) ITALY		ESEGUITO: G.B.
					SEGUE 4

40

41

42

43

44

45

46

47

48

49

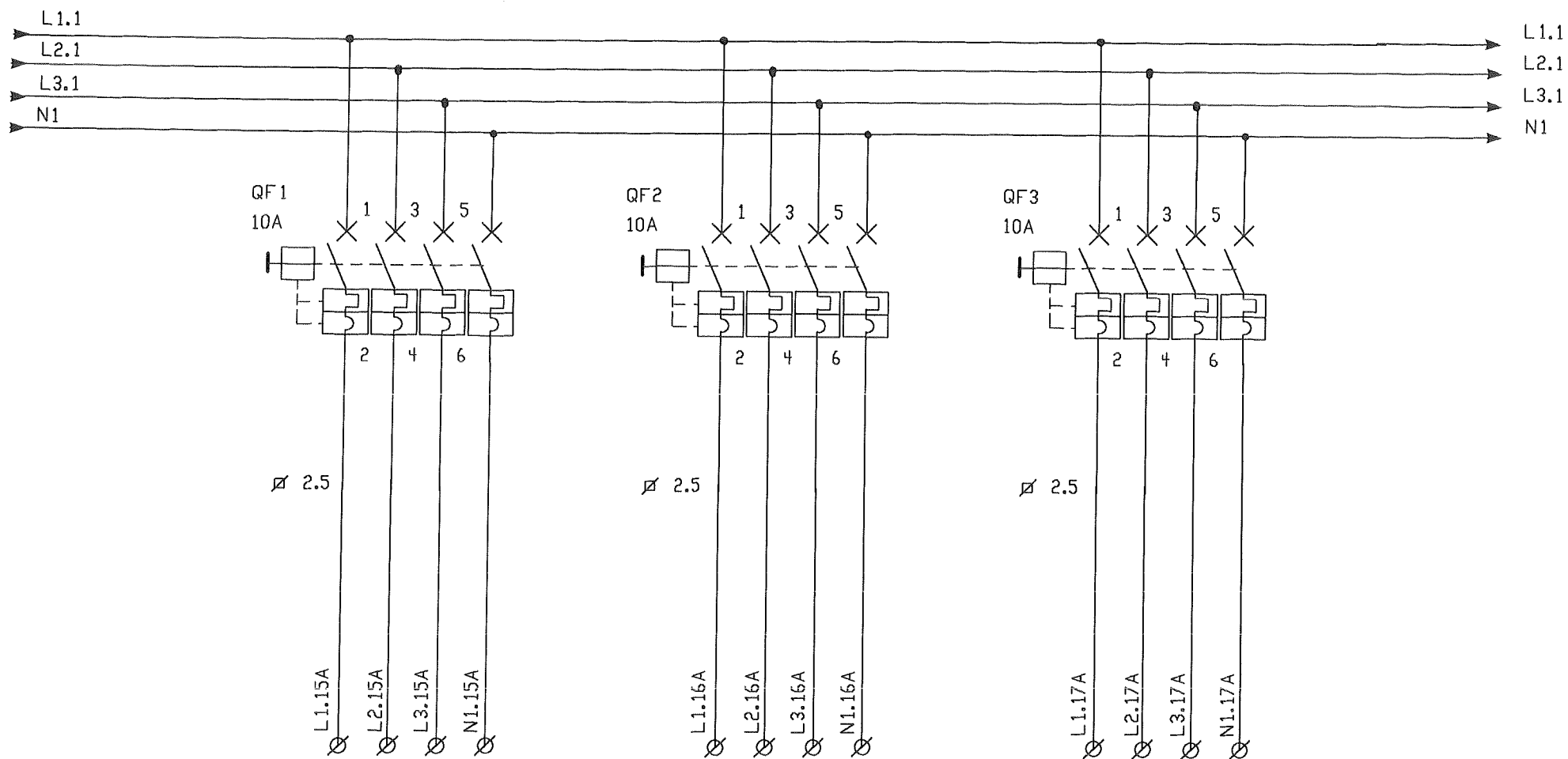

LINEA ALIMENTATORE 1

ESTRUSORE A

LINEA ALIMENTATORE 2

ESTRUSORE A

LINEA ALIMENTATORE 3

ESTRUSORE A



C.G. Sistemi S.p.A.

di Carrocci & Chiarugbelli

DIS. N.

MACCHINA/DESCRIZIONE:

ALIMENTAZIONI ESTERNE

N. FILE

C.G. SISTEMI s.n.c. V. G. Cantore N°10 Tel. 0331 733197 Fax. 0331 264077

POS. ARCH.

DATA: 16/05/2001

email. c.g.sistemi@libero.it

CARDANO AL CAMPO (VA) ITALY

ORDINE: 2001

FOGLIO 4

COMMESSA: 065.A

ESEGUITO: G.B.

SEGUE 5

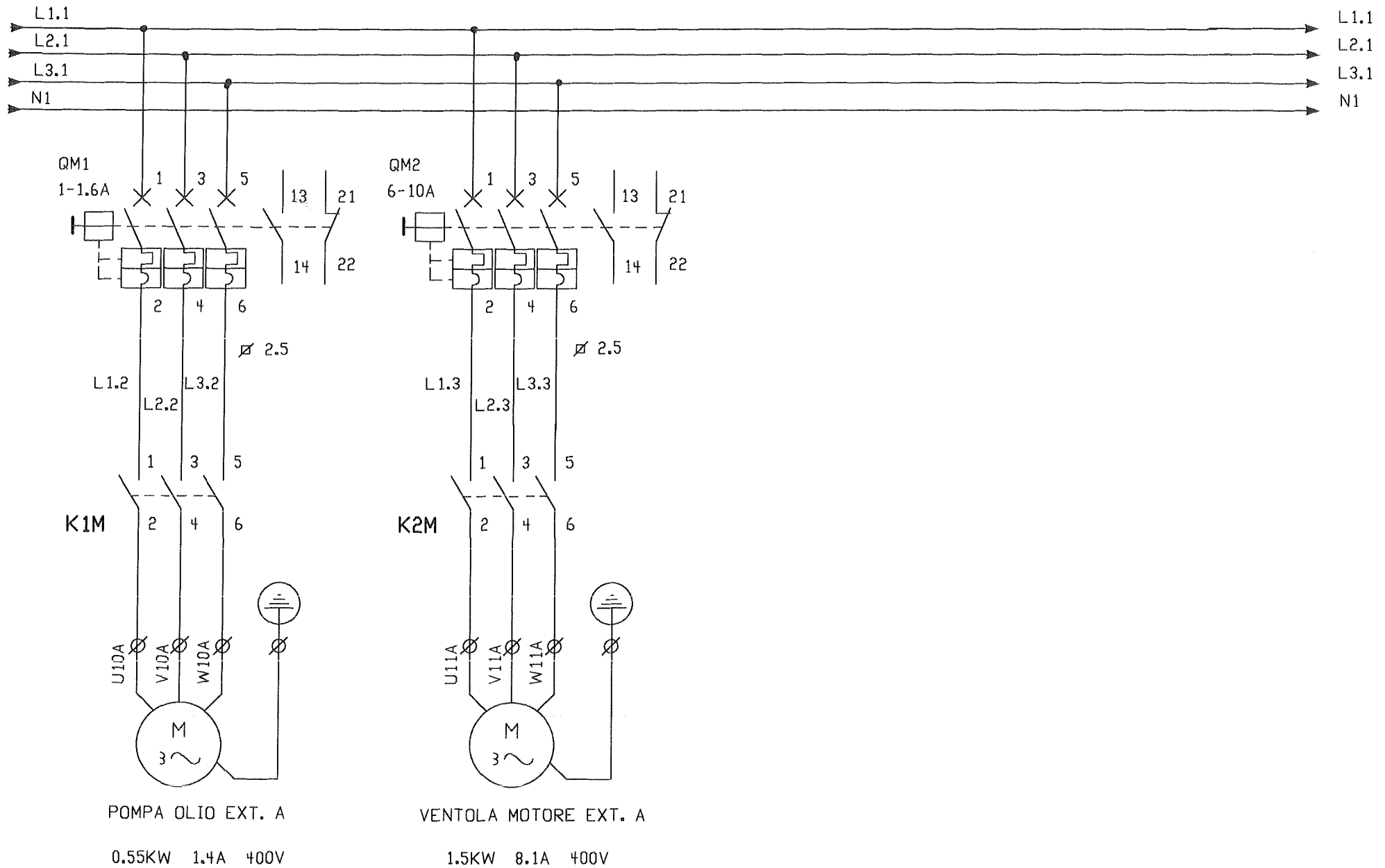

60

61

62

63

64

65

66

67

68

69

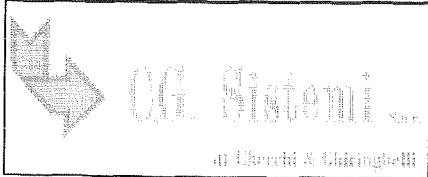
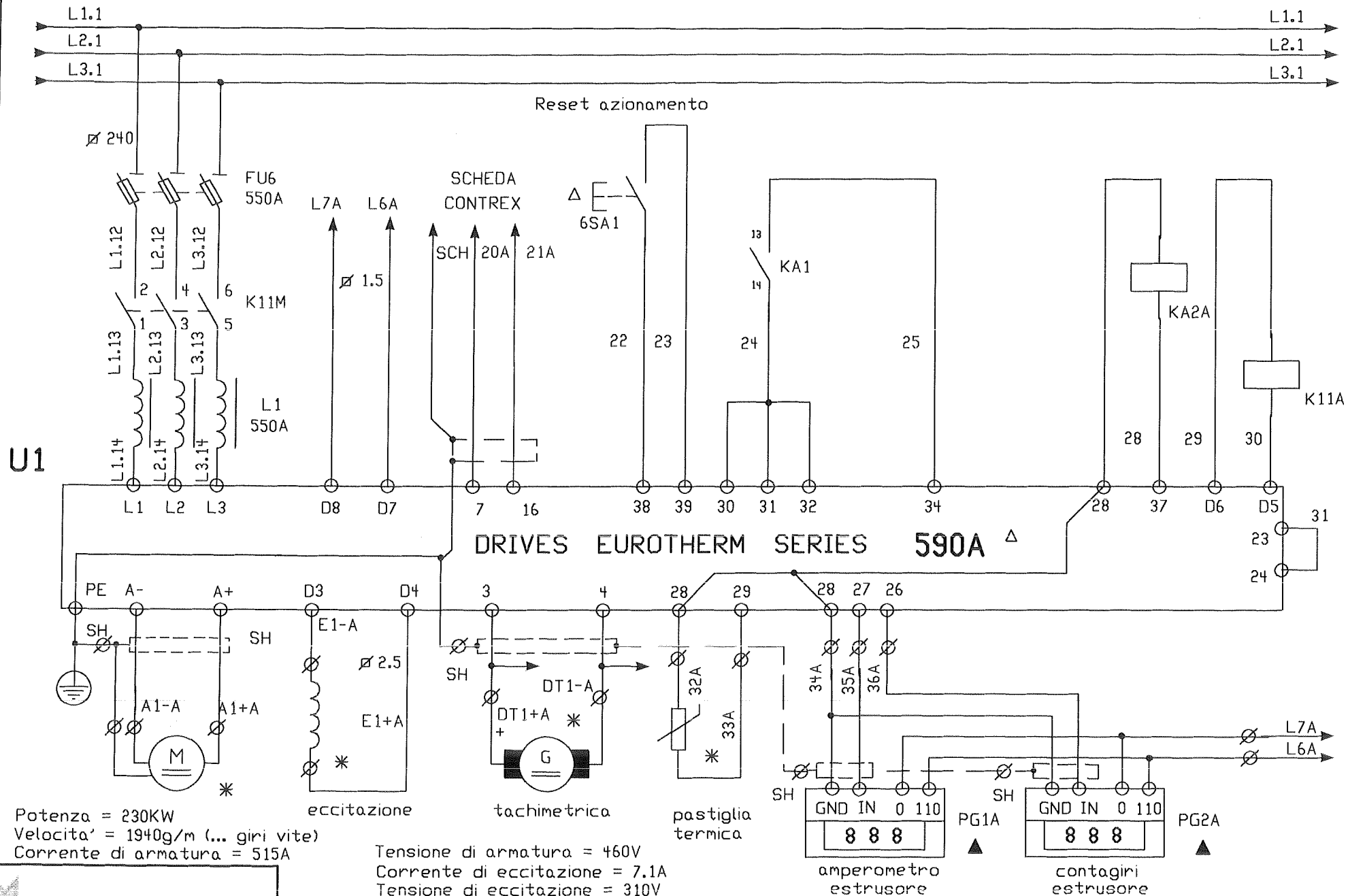

DIS. N.	MACCHINA/DESCRIZIONE: MOTORE ESTRUSORE C.C.			ORDINE: 2001	FOGLIO 6
N. FILE	C.G. SISTEMI s.n.c. V. G. Cantore N°10 Tel. 0331 733197 Fax. 0331 264077			COMMESSA: 065.A	SEGUE 7
POS. ARCH.	DATA: 16/05/2001	email. c.g.sistemi@libero.it	CARDANO AL CAMPO (VA) ITALY	ESEGUITO: G.B.	

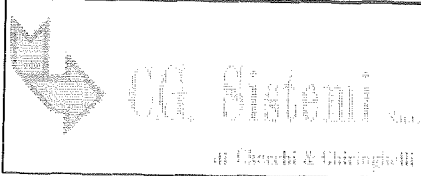
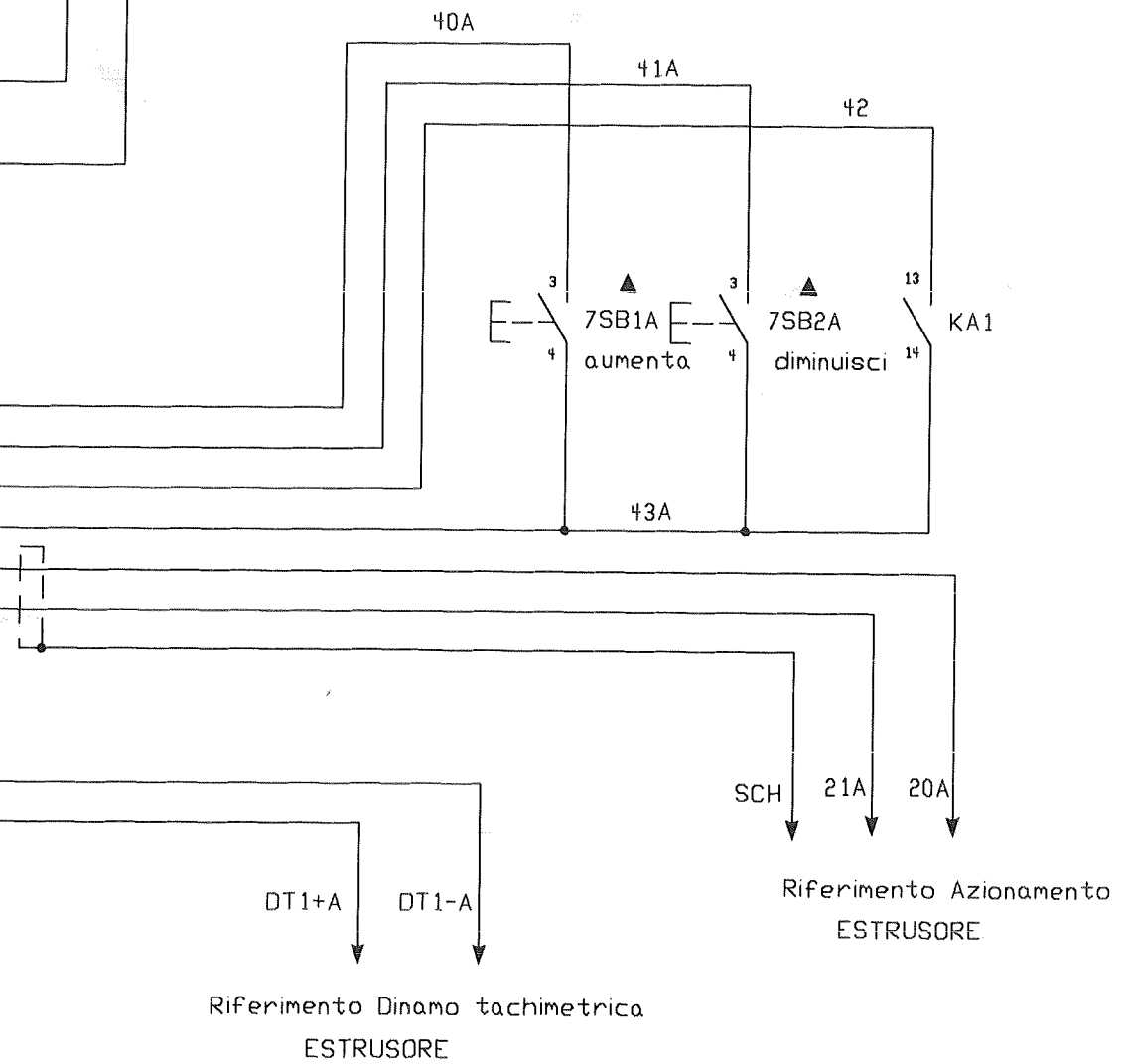
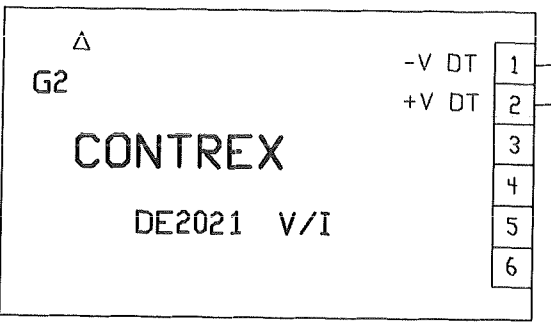
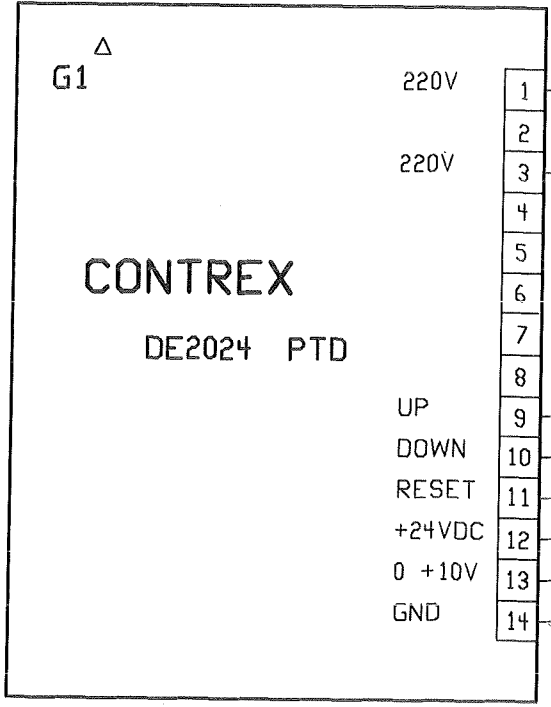
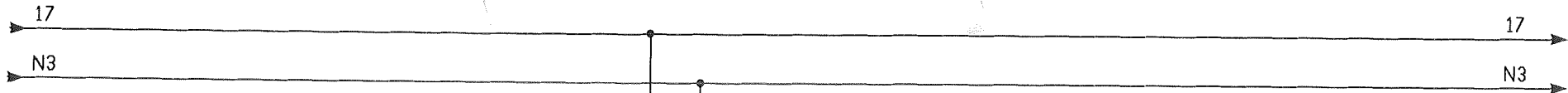

DIS. N.	MACCHINA/DESCRIZIONE: COMANDI				ORDINE: 2001	FOGLIO 7
N. FILE	C.G. SISTEMI S.n.C.	V. G. Cantore N°10	Tel. 0331 733197	Fax. 0331 264077	COMMESSA: 065.A	SEGUE 8
POS. ARCH.	DATA: 16/05/2001	email. c.g.sistemi@libero.it	CARDANO AL CAMPO (VA) ITALY		ESEGUITO: G.B.	

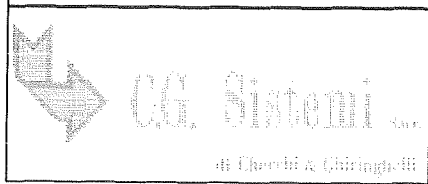
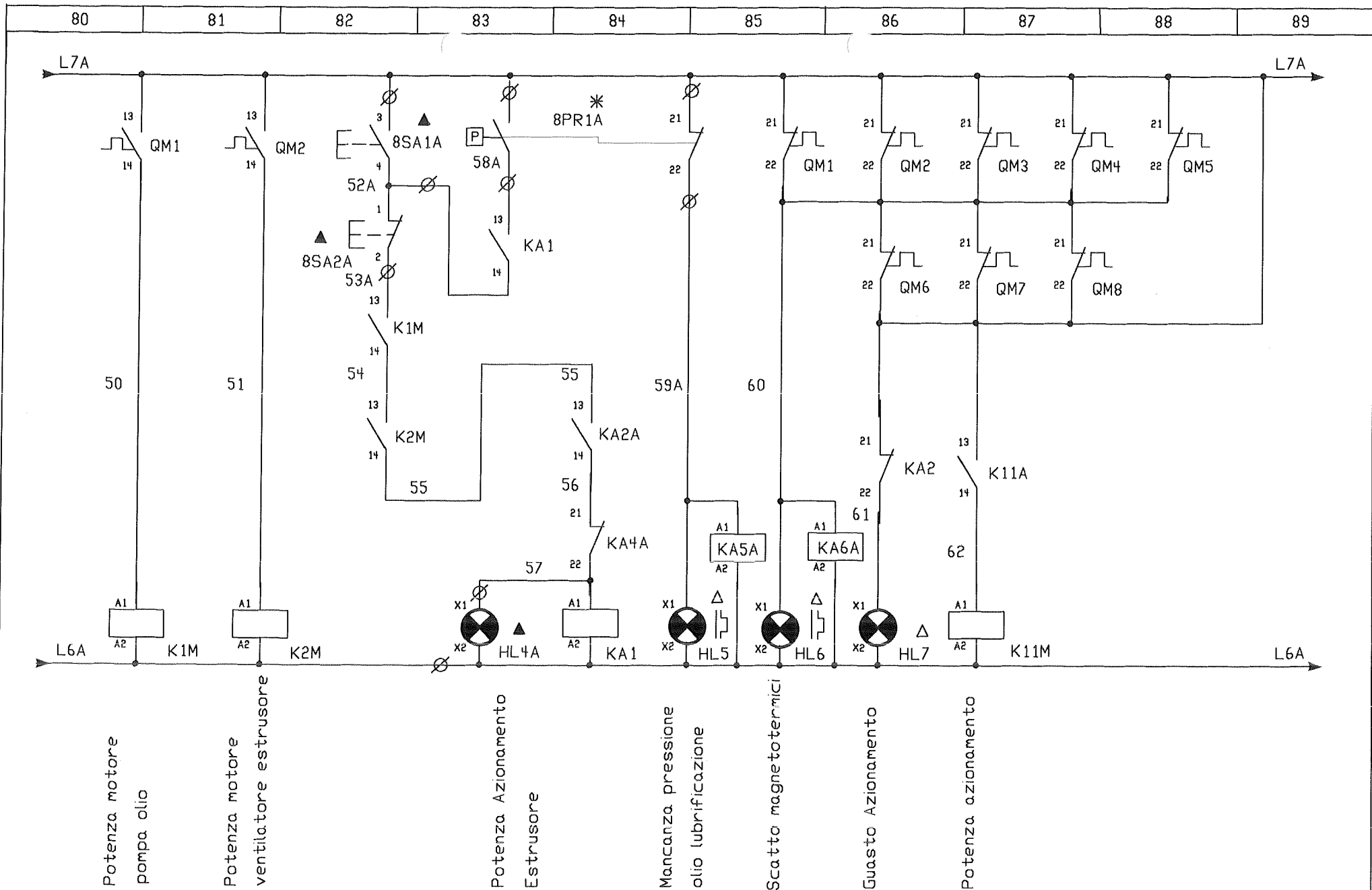

DIS. N.	MACCHINA/DESCRIZIONE: COMANDI			ORDINE: 2001	FOGLIO 8
N. FILE	C.G. SISTEMI s.n.c. V. G. Cantore N°10 Tel. 0331 733197 Fax. 0331 264077			COMMESSA: 065.A	SEGUE 9
POS. ARCH.	DATA: 16/05/2001	email. c.g.sistemi@libero.it	CARDANO AL CAMPO (VA) ITALY	ESEGUITO: G.B.	

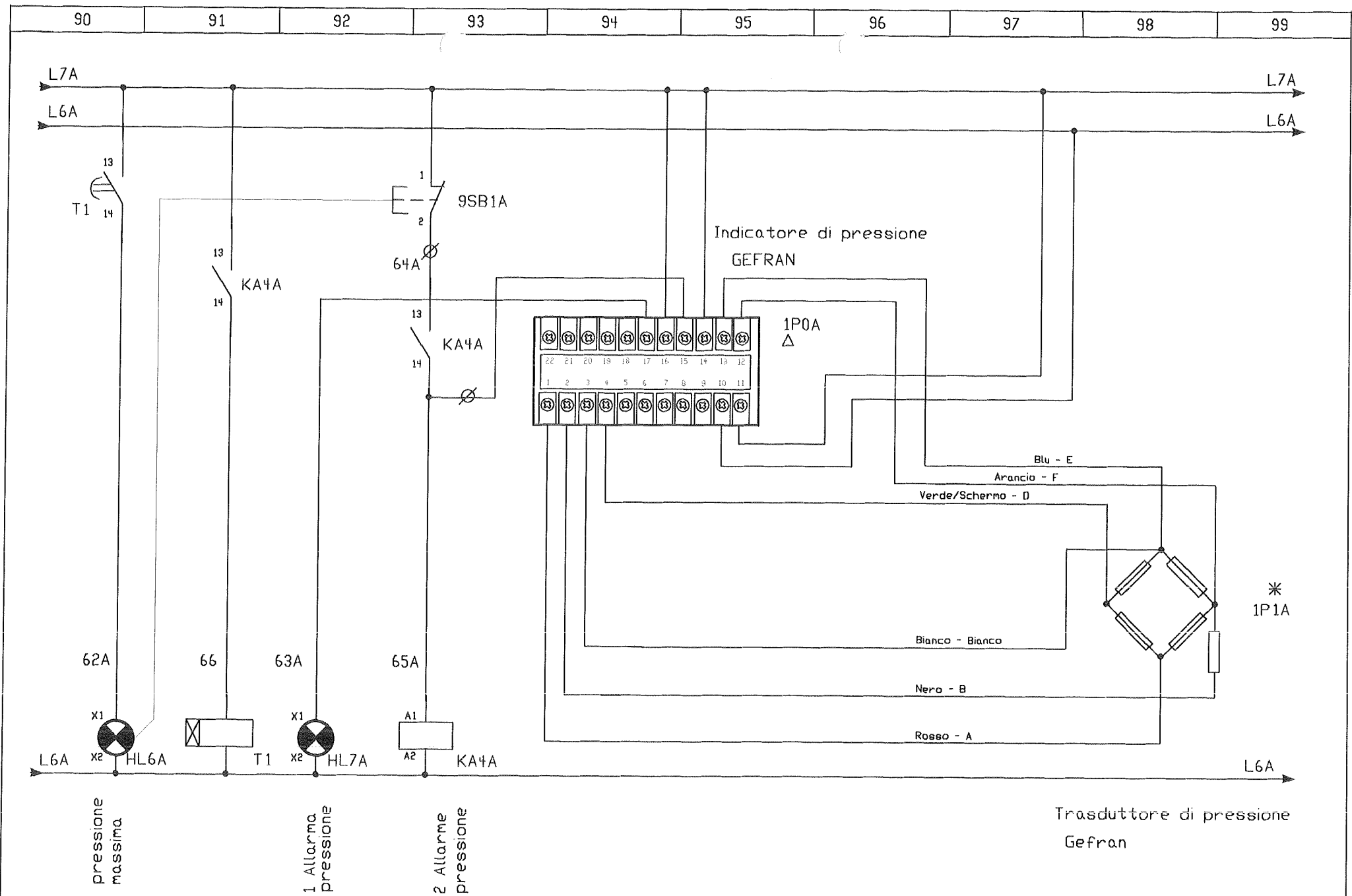

pressione massima

1 Allarme pressione

2 Allarme pressione

Trasduttore di pressione Gefran



DIS. N.	MACCHINA/DESCRIZIONE: LETTURA DI PRESSIONE			ORDINE: 2001	FOGLIO 9
N. FILE	C.G. SISTEMI s.n.c. V. G. Cantore N°10 Tel. 0331 733197 Fax. 0331 264077			COMMESSA: 065.A	SEGUE 10
POS. ARCH.	DATA: 16/05/2001	email. c.g.sistemi@libero.it	CARDANO AL CAMPO (VA) ITALY	ESEGUITO: G.B.	

110

101

102

103

104

105

106

107

108

109

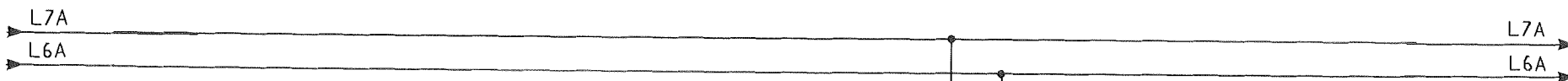

GEFRAN ▲ lettore MELT- materiale fuso

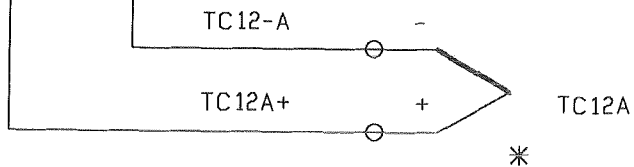
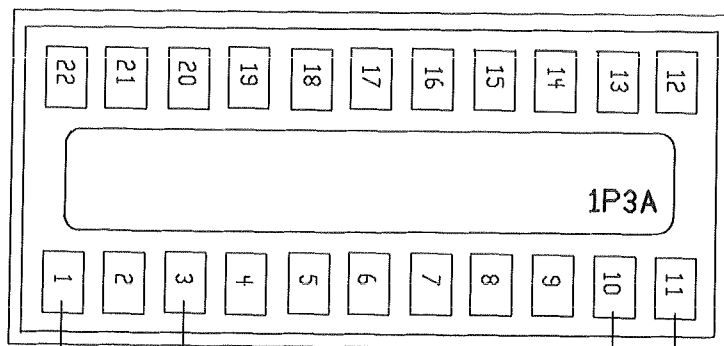

DIS. N.	MACCHINA/DESCRIZIONE: LETTURA MELT			ORDINE: 2001	FOGLIO 10
N. FILE	C.G. SISTEMI s.n.c.	V. G. Cantore N°10	Tel. 0331 733197	COMMESSA: 065.A	SEGUE 11
POS. ARCH.	DATA: 16/05/2001	email. c.g.sistemi@libero.it	Fax. 0331 264077	ESEGUITO: G.B.	
	CARDANO AL CAMPO (VA) ITALY				

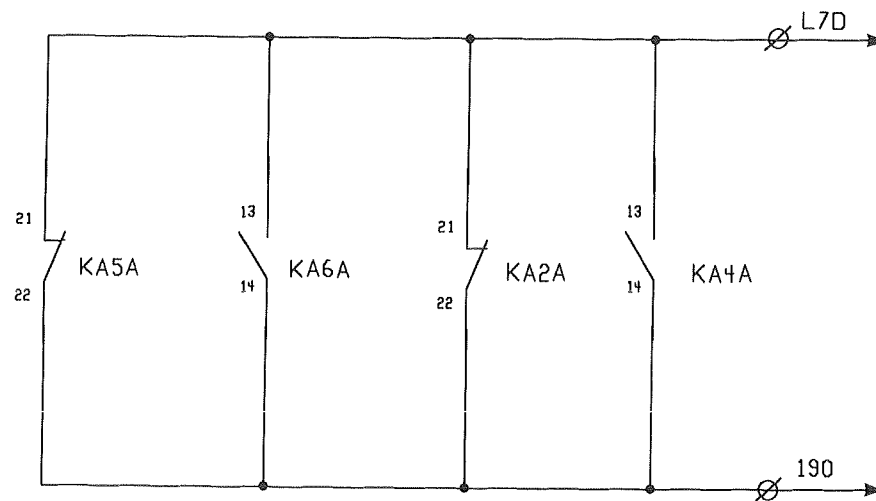

RIPETIZIONE SPIA ALLARME SU PULPITO



C.G. Sistemi

di Drechi & Cristofolini

DIS. N.	MACCHINA/DESCRIZIONE: RIPETIZIONE ALLARME			ORDINE: 2001	FOGLIO 11
N. FILE	C.G. SISTEMI s.n.c. V. G. Cantore N°10 Tel. 0331 733197 Fax. 0331 264077			COMMESSA: 065.A	SEGUE 12
POS. ARCH.	DATA: 16/05/2001	email. c.g.sistemi@libero.it	CARDANO AL CAMPO (VA) ITALY	ESEGUITO: G.B.	

120

121

122

123

124

125

126

127

128

129

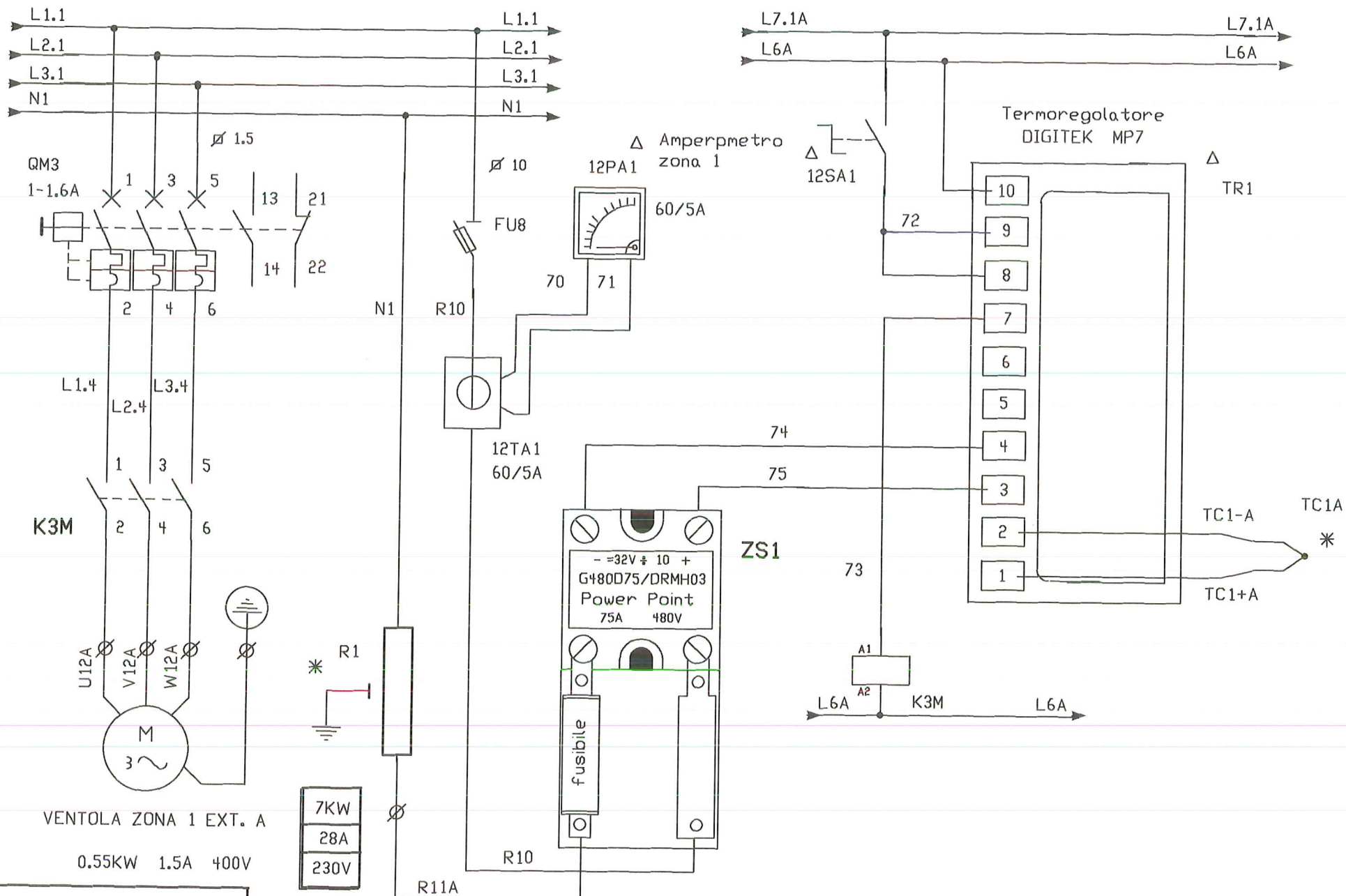

DIS. N.

MACCHINA/DESCRIZIONE:

TERMOREGOLATORE ZONA 1

ORDINE: 2001

FOGLIO 12

N. FILE

C.G. SISTEMI s.n.c. V. G. Cantore N°10 Tel. 0331 733197 Fax. 0331 264077

COMMESSA: 065.A

SEGUE 13

POS. ARCH.

DATA: 16/05/2001 email. c.g.sistemi@libero.it CARDANO AL CAMPO (VA) ITALY

ESEGUITO: G.B.

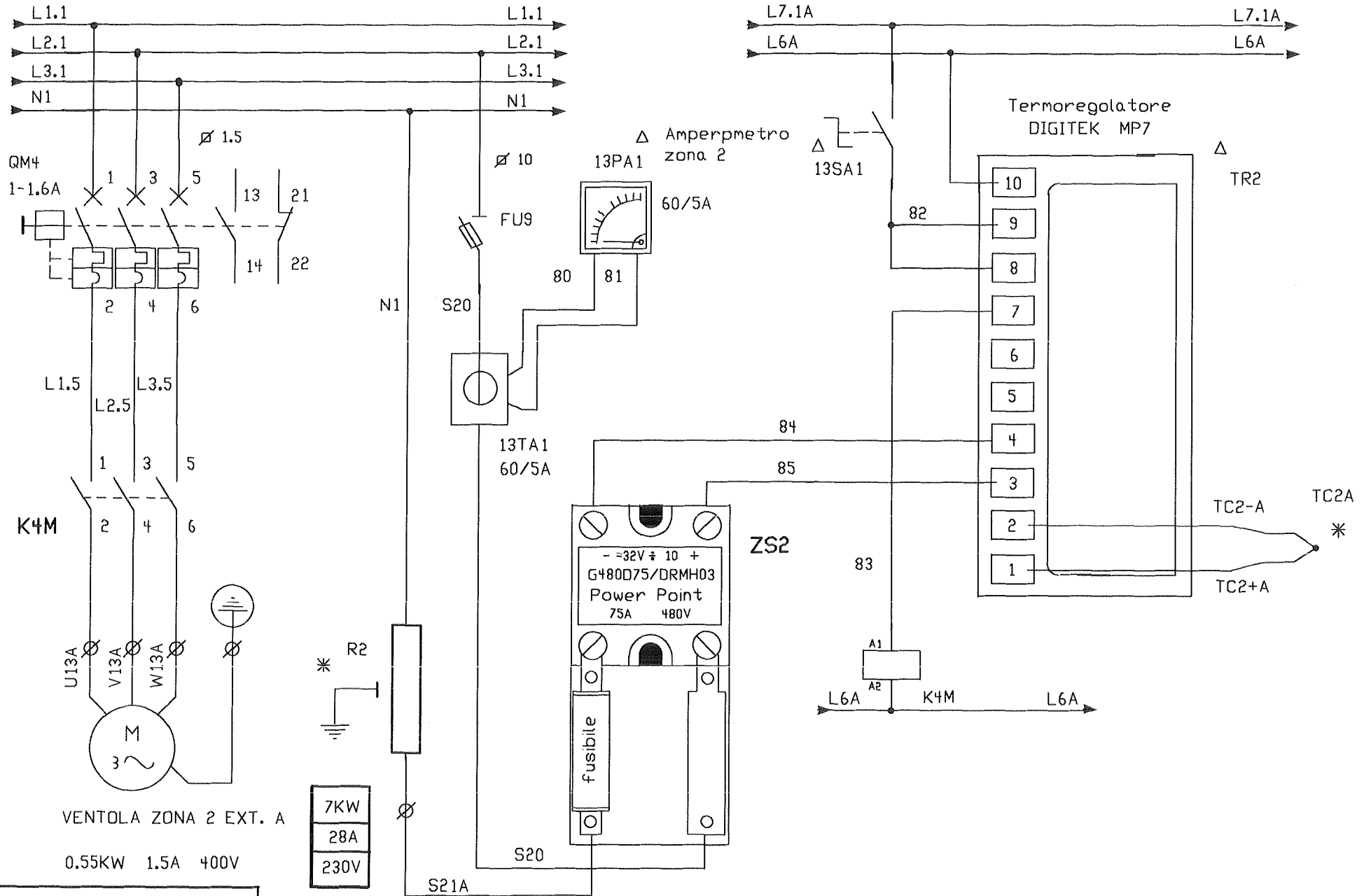

DIS. N.	MACCHINA/DESCRIZIONE: TERMOREGOLATORE ZONA 2			ORDINE: 2001	FOGLIO 13
N. FILE	C.G. SISTEMI S.p.A. V. G. Cantore N°10 Tel. 0331 733197 Fax. 0331 264077			COMMESSA: 065.A	SEGUE 14
POS. ARCH.	DATA: 16/05/2001	email: c.g.sistemi@libero.it	CARDANO AL CAMPO (VA) ITALY	ESEGUITO: G.B.	

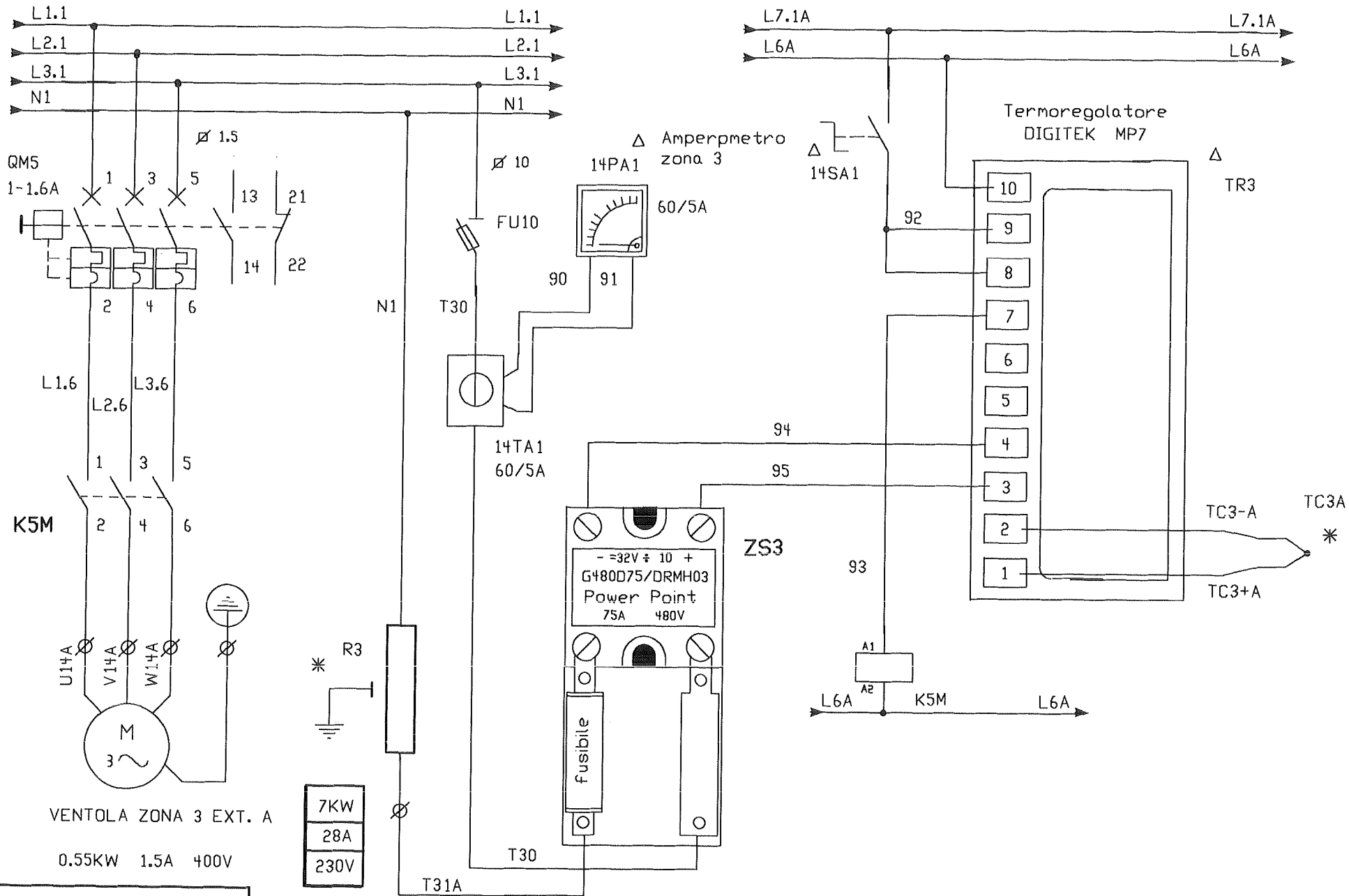

DIS. N.	MACCHINA/DESCRIZIONE: TERMOREGOLATORE ZONA 3			ORDINE: 2001	FOGLIO 14
N. FILE	C.G. SISTEMI s.n.c. V. G. Cantore N°10 Tel. 0331 733197 Fax. 0331 264077			COMMESSA: 065.A	SEGUE 15
POS. ARCH.	DATA: 16/05/2001	email. c.g.sistemi@libero.it	CARDANO AL CAMPO (VA) ITALY	ESEGUITO: G.B.	

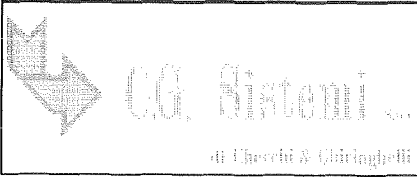
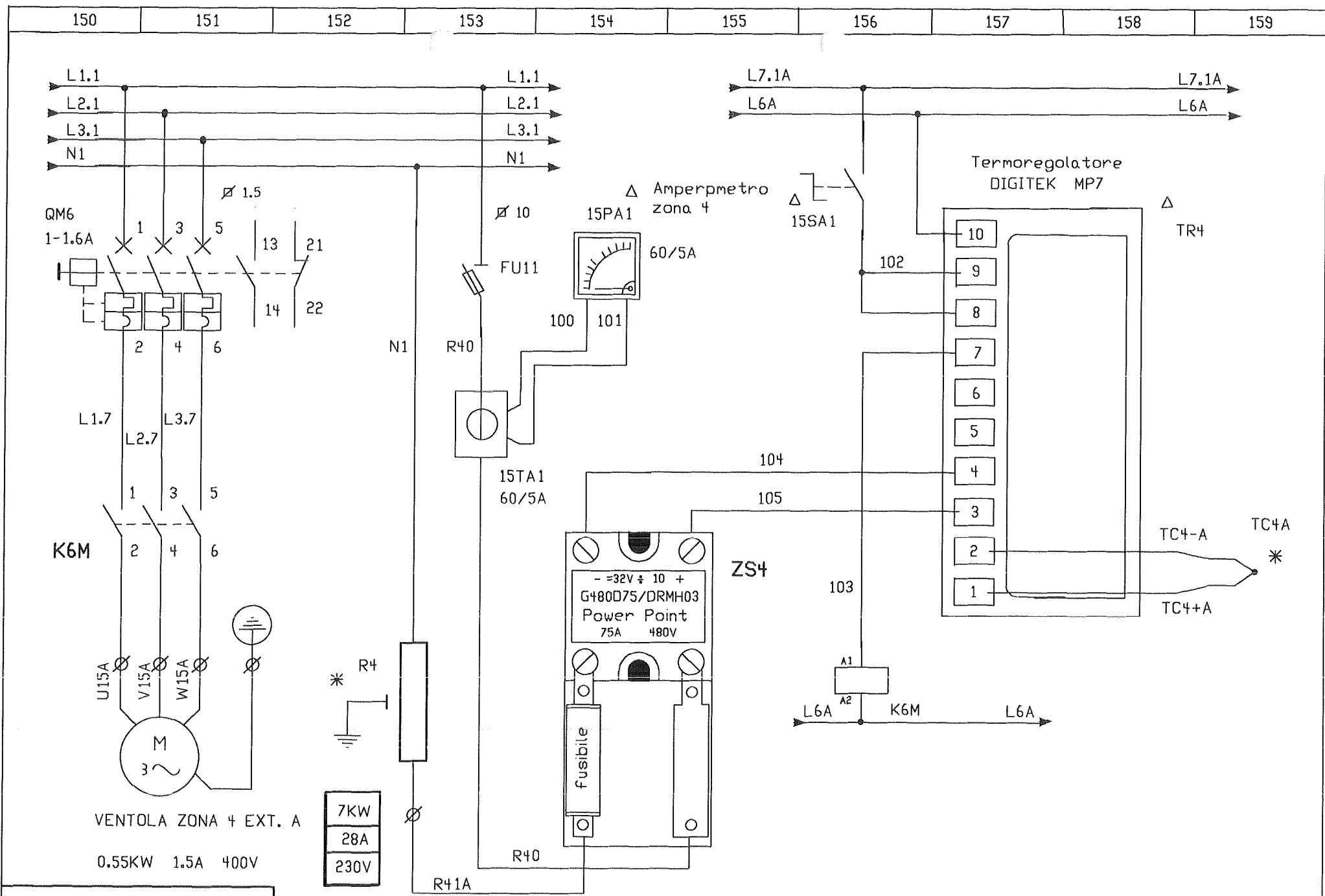

DIS. N.	MACCHINA/DESCRIZIONE: TERMOREGOLATORE ZONA 4			ORDINE: 2001	FOGLIO 15
N. FILE	C.G. SISTEMI s.n.c. V. G. Cantore N°10 Tel. 0331 733197 Fax. 0331 264077			COMMESSA: 065.A	SEGUE 16
POS. ARCH.	DATA: 16/05/2001	email. c.g.sistemi@libero.it	CARDANO AL CAMPO (VA) ITALY	ESEGUITO: G.B.	

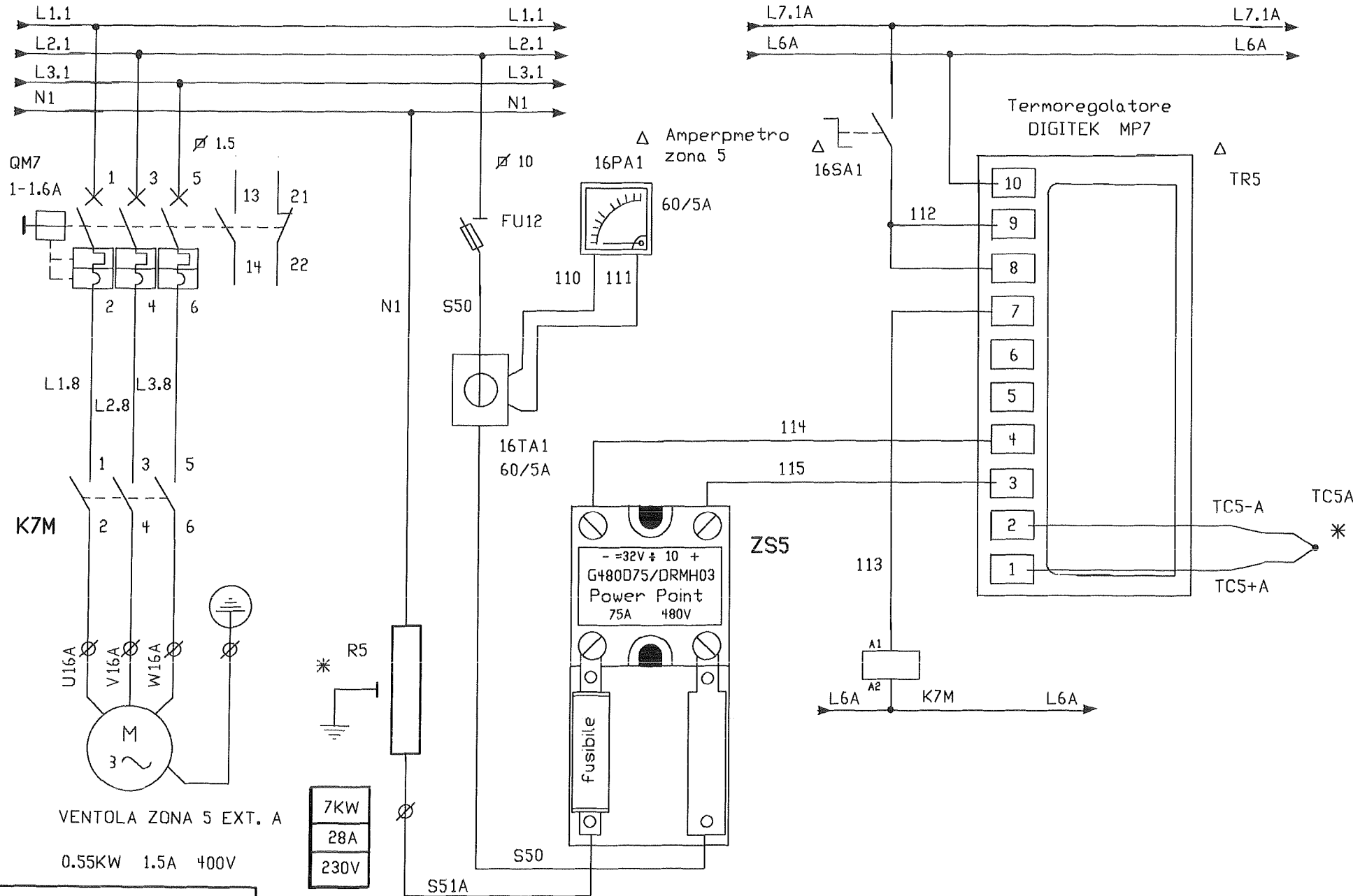

VENTOLA ZONA 5 EXT. A

0.55KW 1.5A 400V

7KW
28A
230V



DIS. N.	MACCHINA/DESCRIZIONE: TERMOREGOLATORE ZONA 5			ORDINE: 2001	FOGLIO 16
N. FILE	C.G. SISTEMI s.n.c. V. G. Cantore N°10 Tel. 0331 733197 Fax. 0331 264077			COMMESSA: 065.A	SEGUE 17
POS. ARCH.	DATA: 16/05/2001	email. c.g.sistemi@libero.it	CARDANO AL CAMPO (VA) ITALY	ESEGUITO: G.B.	

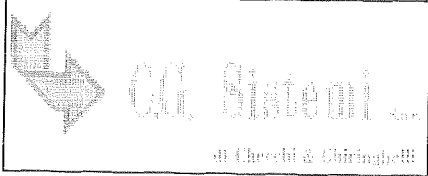
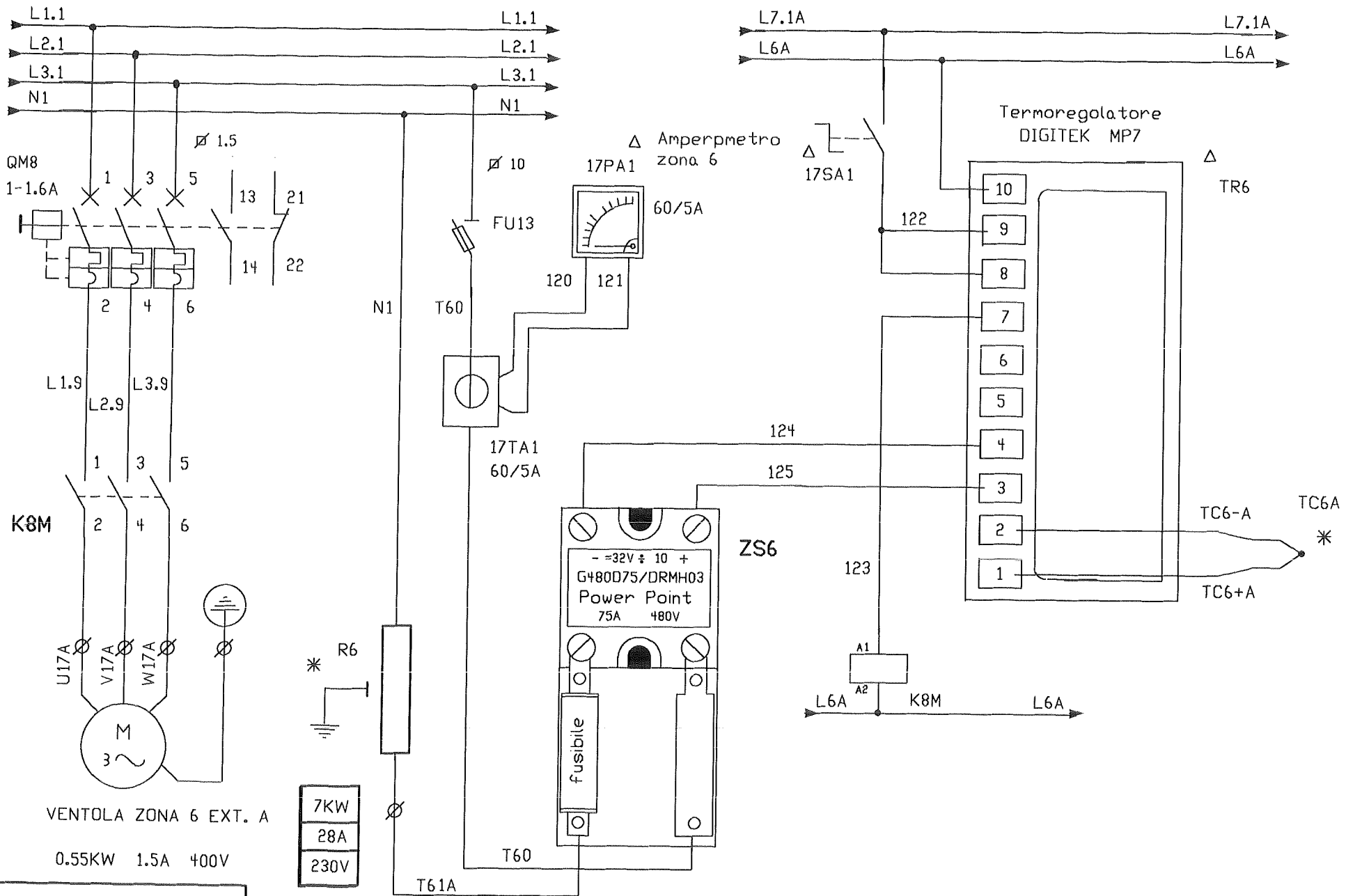

DIS. N.	MACCHINA/DESCRIZIONE: TERMOREGOLATORE ZONA 6			ORDINE: 2001	FOGLIO 17
N. FILE	C.G. SISTEMI s.n.c.	V. G. Cantore N°10	Tel. 0331 733197	COMMESSA: 065.A	SEGUE 18
POS. ARCH.	DATA: 16/05/2001	email. c.g.sistemi@libero.it	Fax. 0331 264077	ESEGUITO: G.B.	
	CARDANO AL CAMPO (VA) ITALY				

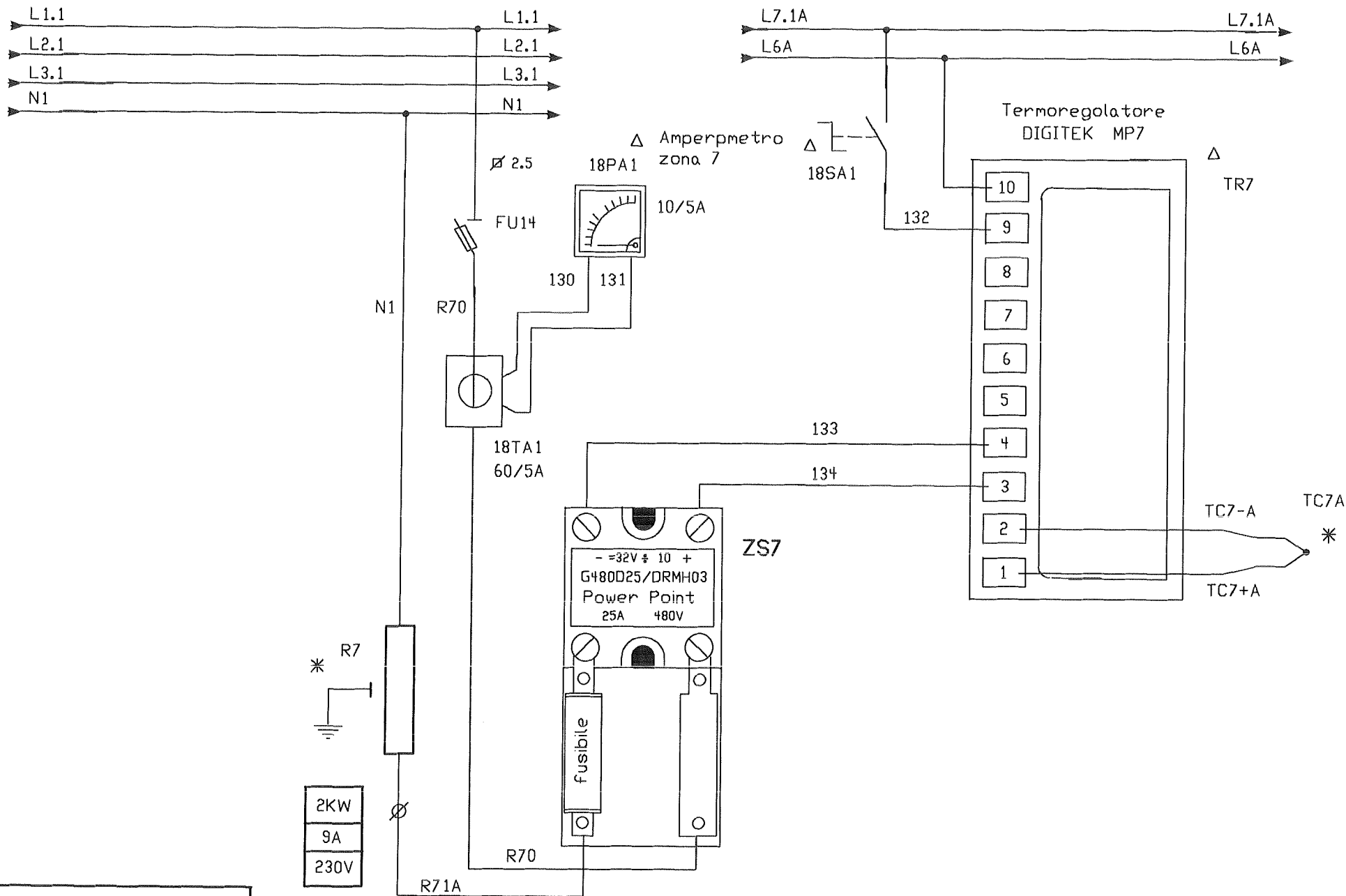

DIS. N.	MACCHINA/DESCRIZIONE: TERMOREGOLATORE ZONA 7 ESTRUSORE			ORDINE: 2001	FOGLIO 18
N. FILE	C.G. SISTEMI s.n.c. V. G. Cantore N°10 Tel. 0331 733197 Fax. 0331 264077			COMMESSA: 065.A	SEGUE 19
POS. ARCH.	DATA: 16/05/2001	email. c.g.sistemi@libero.it	CARDANO AL CAMPO (VA) ITALY	ESEGUITO: G.B.	

190

191

192

193

194

195

196

197

198

199

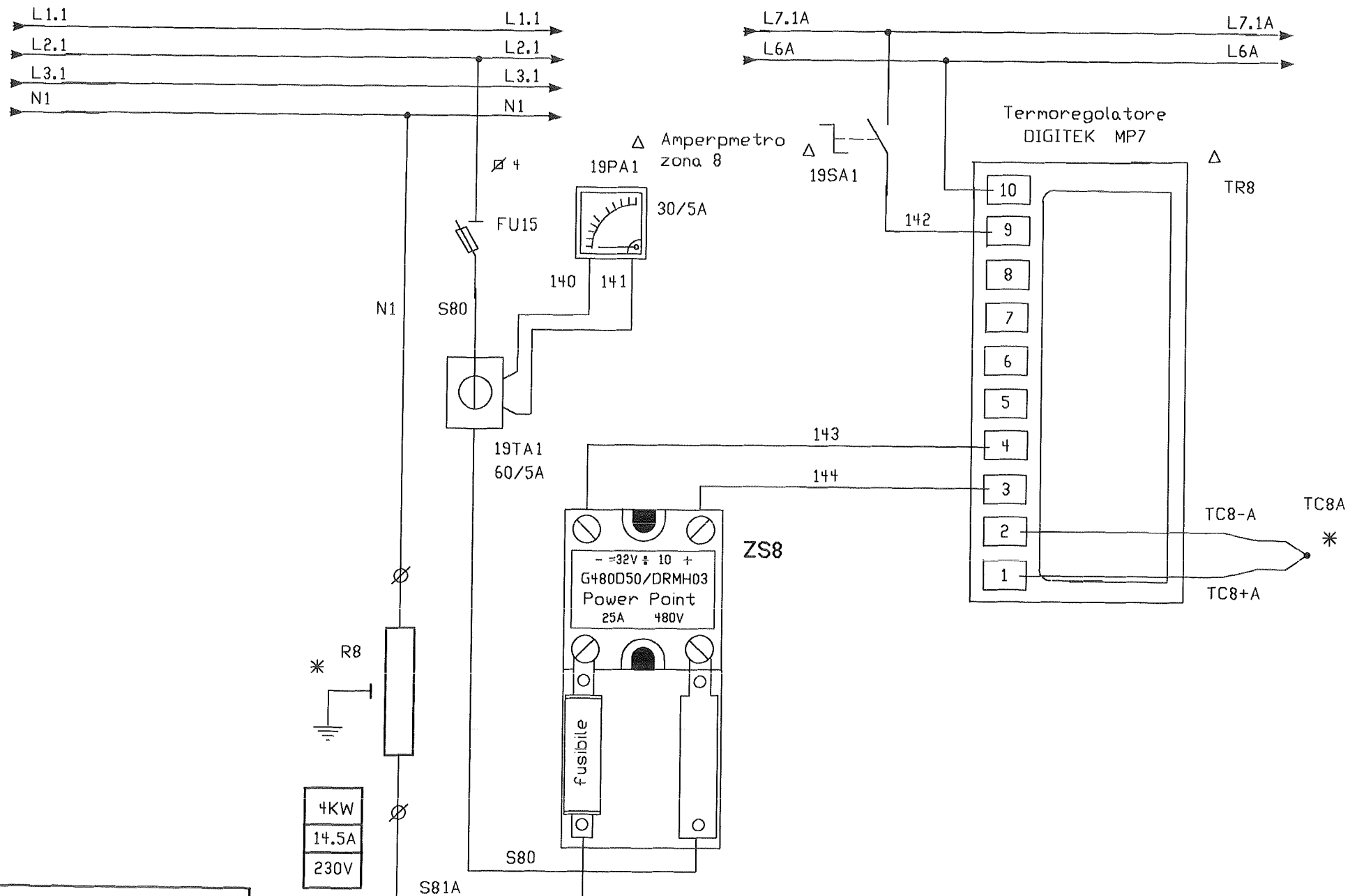

C.G. Sistemi

di Ingegneria & Costruzioni

DIS. N.	MACCHINA/DESCRIZIONE: TERMOREGOLATORE ZONA 8 CAMBIA FILTRO			ORDINE: 2001	FOGLIO 19
N. FILE	C.G. SISTEMI s.n.c. V. G. Cantore N°10 Tel. 0331 733197 Fax. 0331 264077			COMMESSA: 065.A	SEGUE 20
POS. ARCH.	DATA: 16/05/2001	email. c.g.sistemi@libero.it	CARDANO AL CAMPO (VA) ITALY	ESEGUITO: G.B.	

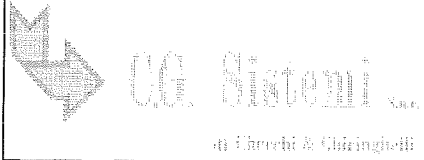
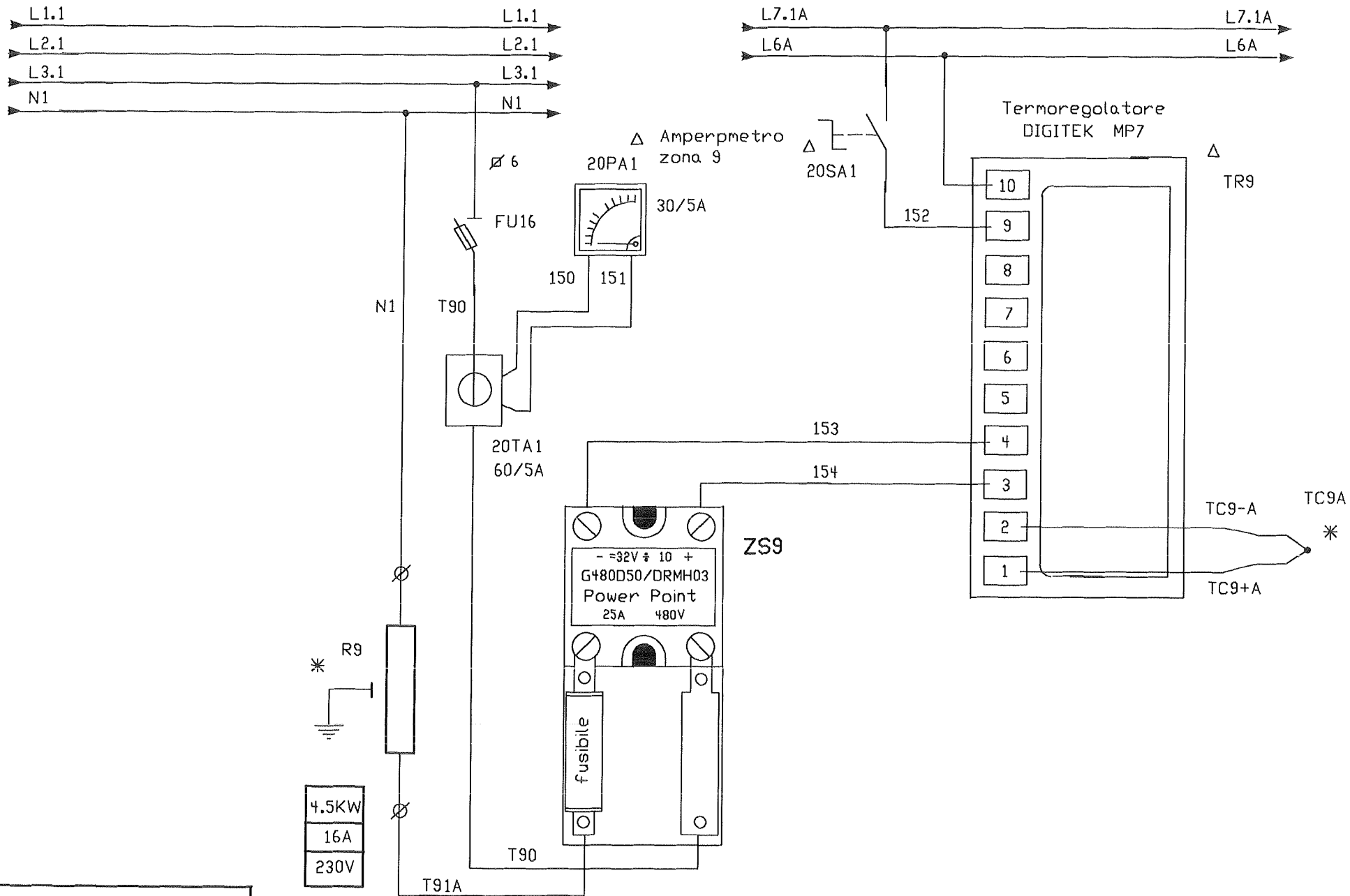

DIS. N.	MACCHINA/DESCRIZIONE: TERMOREGOLATORE ZONA 9 CAMBIA FILTRO			ORDINE: 2001	FOGLIO 20
N. FILE	C.G. SISTEMI s.n.c.	V. G. Cantore N°10	Tel. 0331 733197	Fax. 0331 264077	COMMESSA: 065.A
POS. ARCH.	DATA: 16/05/2001	email. c.g.sistemi@libero.it	CARDANO AL CAMPO (VA) ITALY		ESEGUITO: G.B.

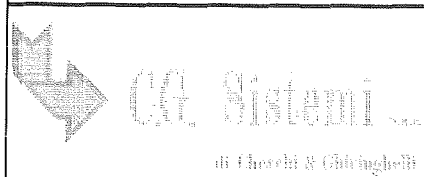
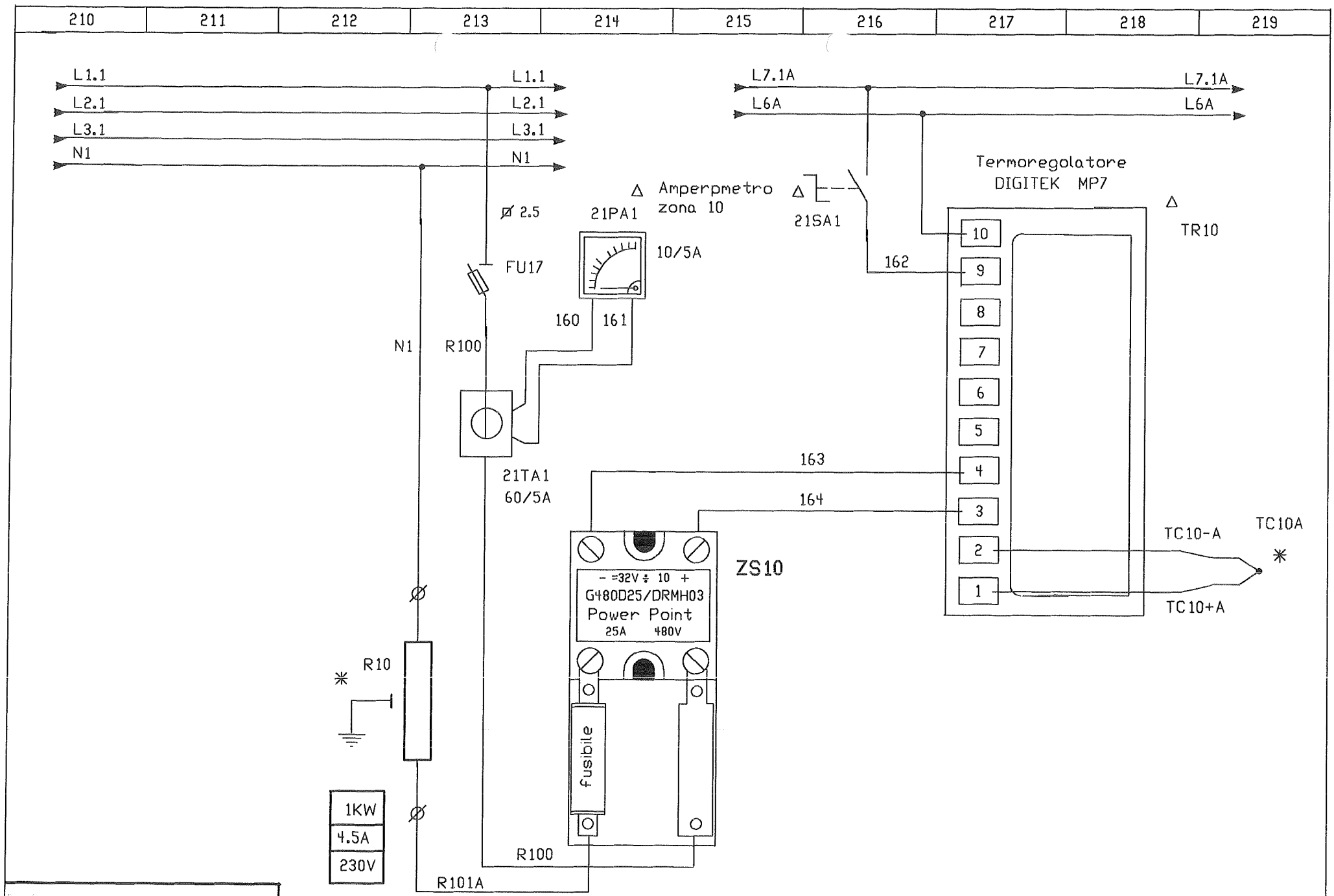

DIS. N.	MACCHINA/DESCRIZIONE: TERMOREGOLATORE ZONA 10 CAMBIA FILTRO			ORDINE: 2001	FOGLIO 21
N. FILE	C.G. SISTEMI s.n.c. V. G. Cantore N°10 Tel. 0331 733197 Fax. 0331 264077			COMMESSA: 065.A	SEGUE 22
POS. ARCH.	DATA: 16/05/2001	email. c.g.sistemi@libero.it	CARDANO AL CAMPO (VA) ITALY	ESEGUITO: G.B.	

220

221

222

223

224

225

226

227

228

229

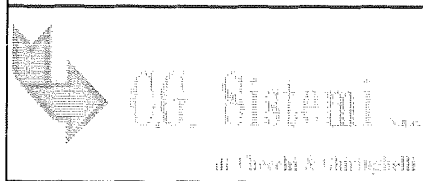
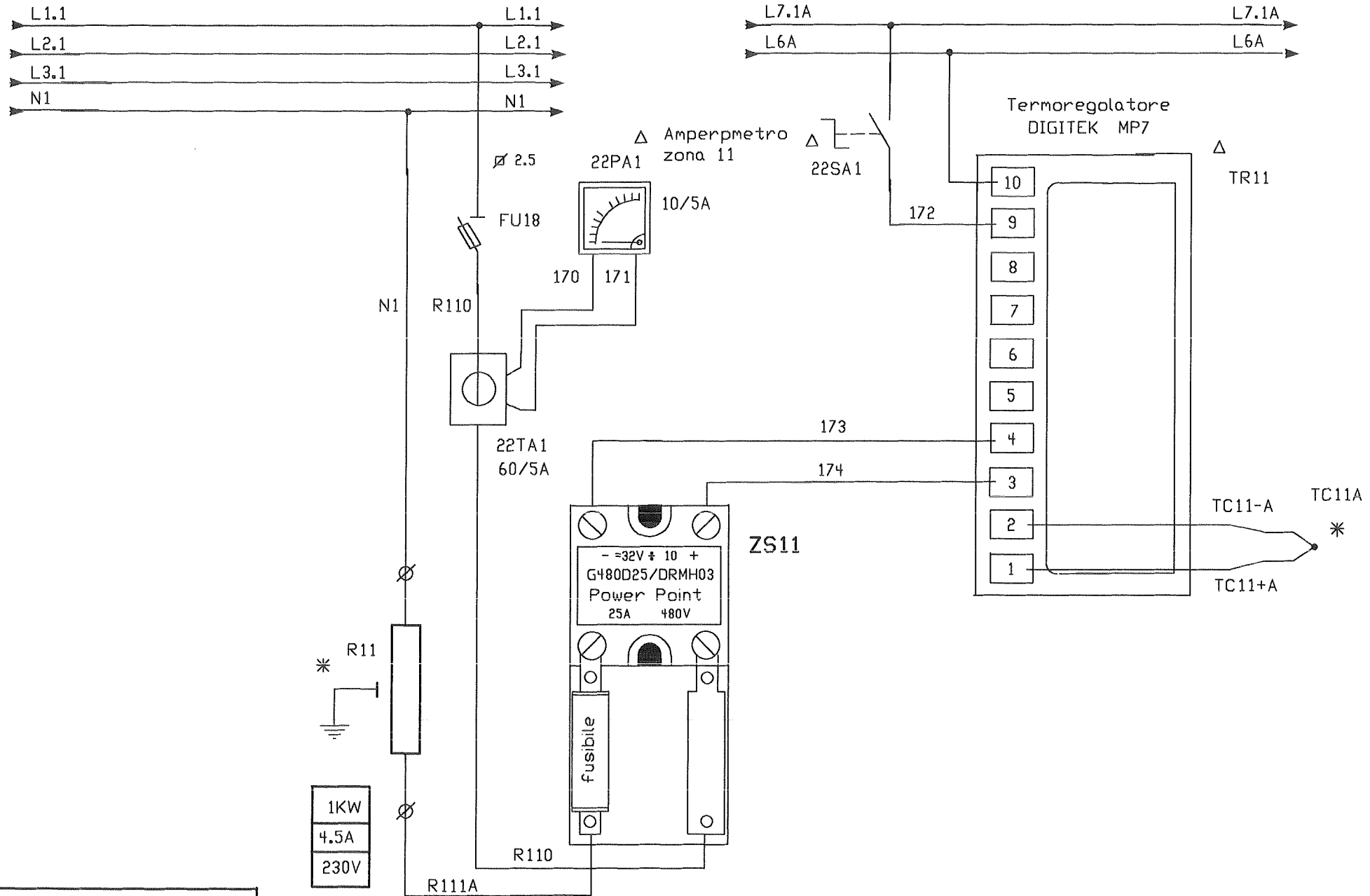

DIS. N.	MACCHINA/DESCRIZIONE: TERMOREGOLATORE ZONA 11 CAMBIA FILTRO			ORDINE: 2001	FOGLIO 22
N. FILE	C.G. SISTEMI s.n.c. V. G. Cantore N°10 Tel. 0331 733197 Fax. 0331 264077			COMMESSA: 065.A	SEGUE 23
POS. ARCH.	DATA: 16/05/2001	enail. c.g.sistemi@libero.it	CARDANO AL CAMPO (VA) ITALY	ESEGUITO: G.B.	

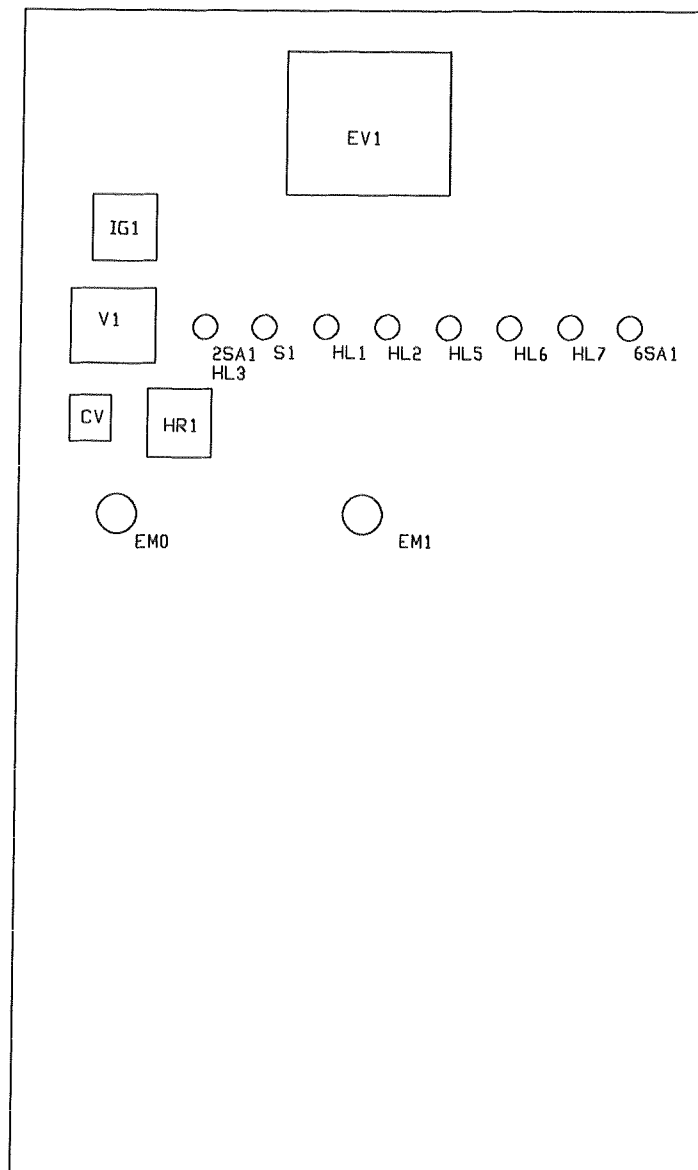

C.G. Sistemi

di Gianni R. Ghisghelli

DIS. N.	MACCHINA/DESCRIZIONE: FRONTE QUADRO			ORDINE: 2001	FOGLIO 23
N. FILE	C.G. SISTEMI s.n.c. V. G. Cantore N°10 Tel. 0331 733197 Fax. 0331 264077			COMMESSA: 065.A	SEGUE 24
POS. ARCH.	DATA: 16/05/2001	email. c.g.sistemi@libero.it	CARDANO AL CAMPO (VA) ITALY	ESEGUITO: G.B.	

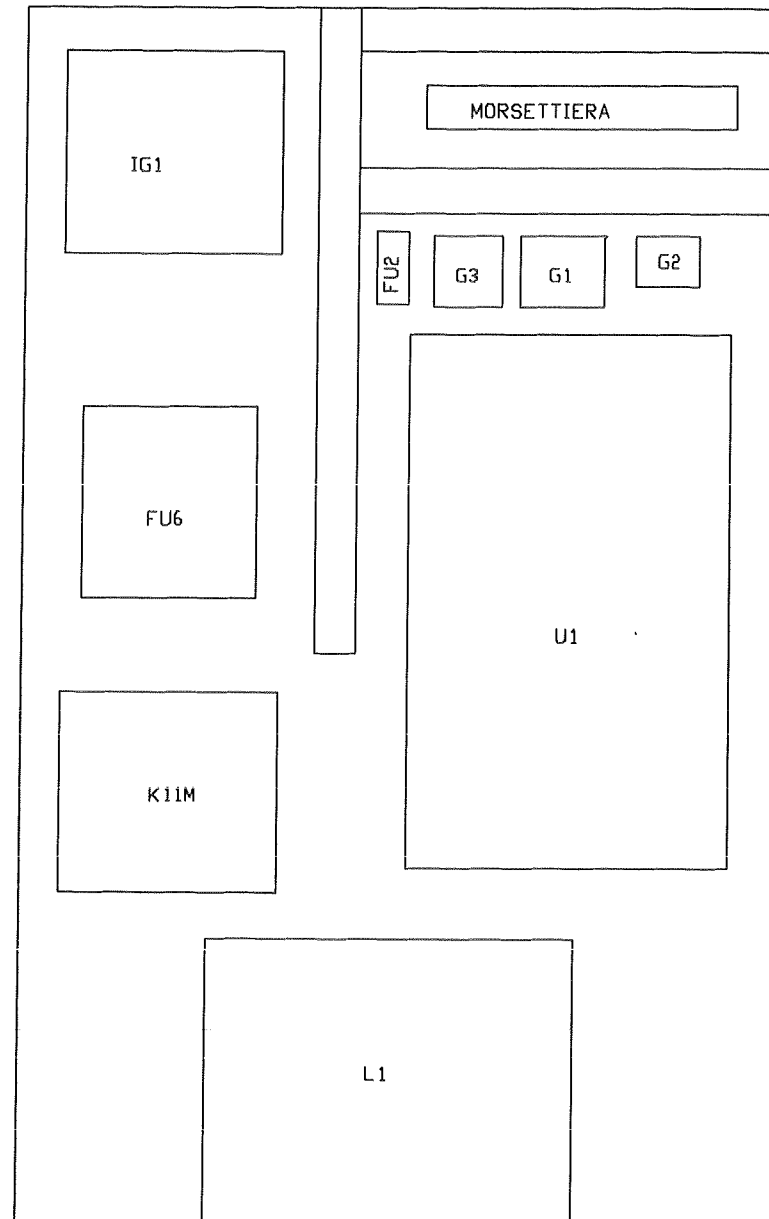

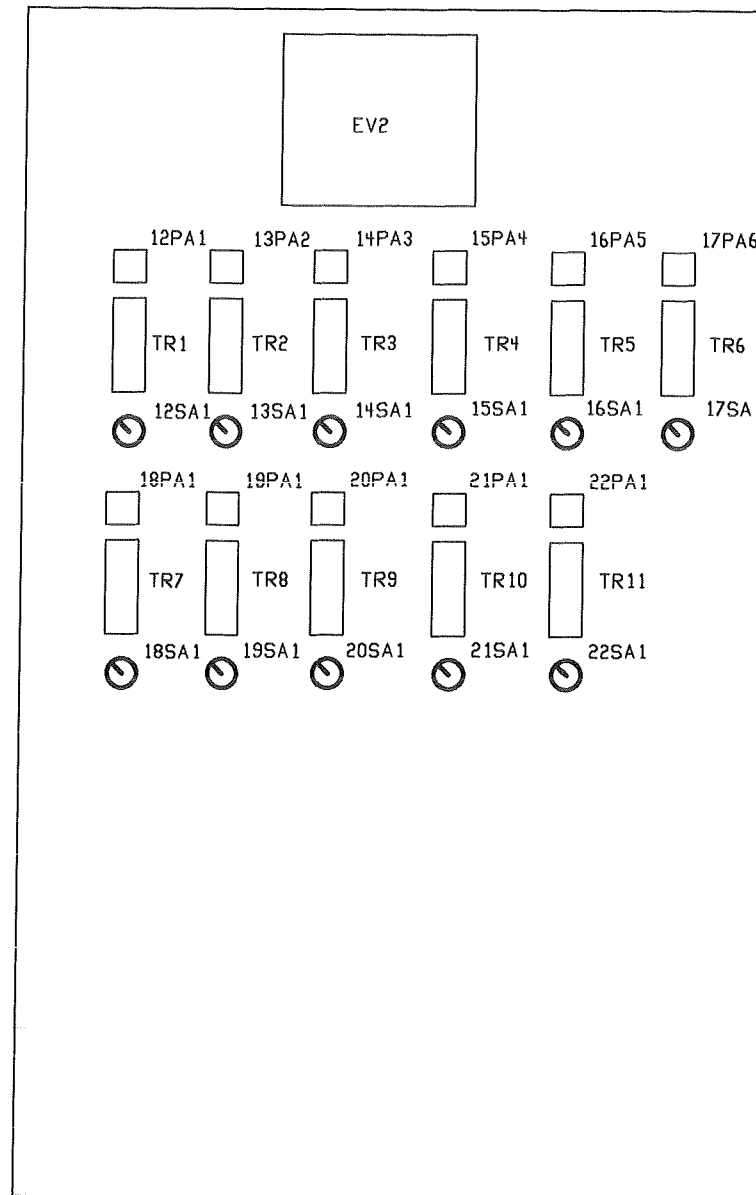

C.G. Sistemi

di Cherchi & Chirighelli

DIS. N.	MACCHINA/DESCRIZIONE: FRONTE QUADRO			ORDINE: 2001	FOGLIO 25
N. FILE	C.G. SISTEMI s.n.c.	V. G. Cantore N°10	Tel. 0331 733197	COMMESSA: 065.A	SEGUE 26
POS. ARCH.	DATA: 16/05/2001	email. c.g.sistemi@libero.it	Fax. 0331 264077	ESEGUITO: G.B.	
	CARDANO AL CAMPO (VA) ITALY				

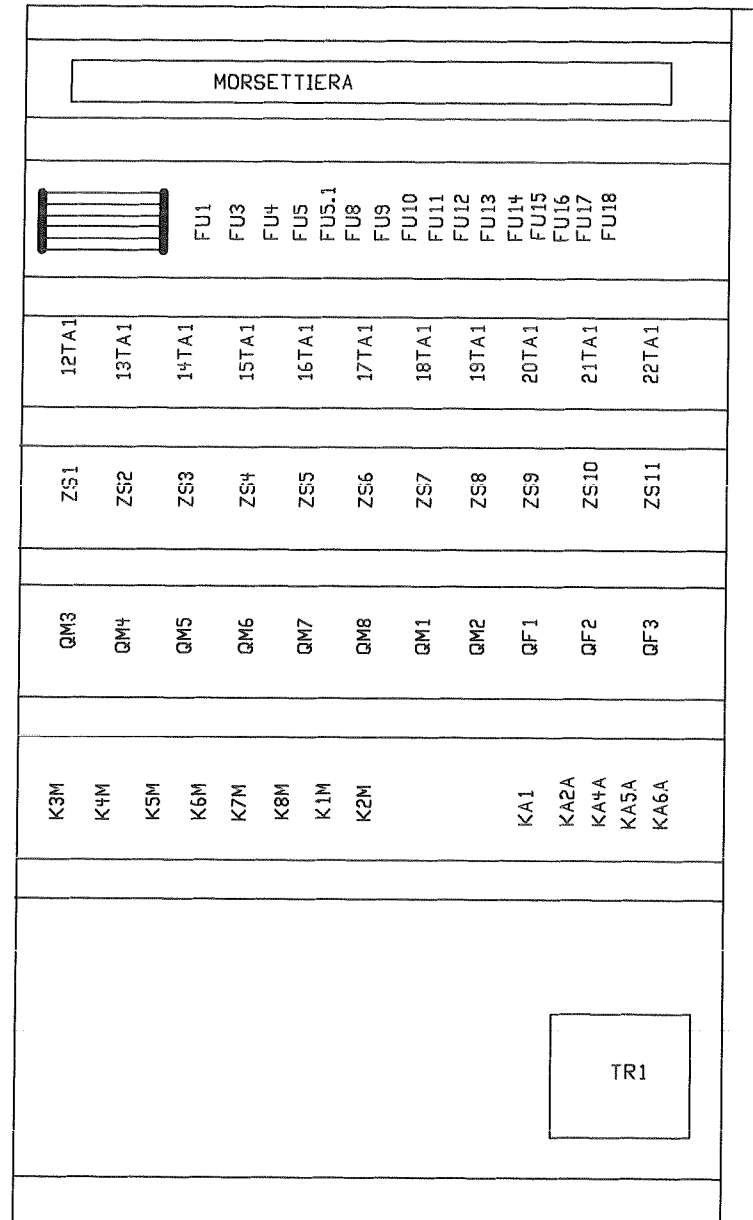

C.G. Sistemi

di Cerchi & Ghiringhelli

DIS. N.

MACCHINA/DESCRIZIONE:

LAYOUT INTERNO

N. FILE

C.G. SISTEMI

s.n.c.

V. G. Cantore N°10

Tel. 0331 733197

Fax. 0331 264077

POS. ARCH.

DATA: 16/05/2001

email. c.g.sistemi@libero.it

CARDANO AL CAMPO (VA) ITALY

ORDINE: 2001

COMMESSA: 065.A

ESEGUITO: G.B.

FOGLIO 26

SEGUE 27

270

271

272

273

274

275

276

277

278

279

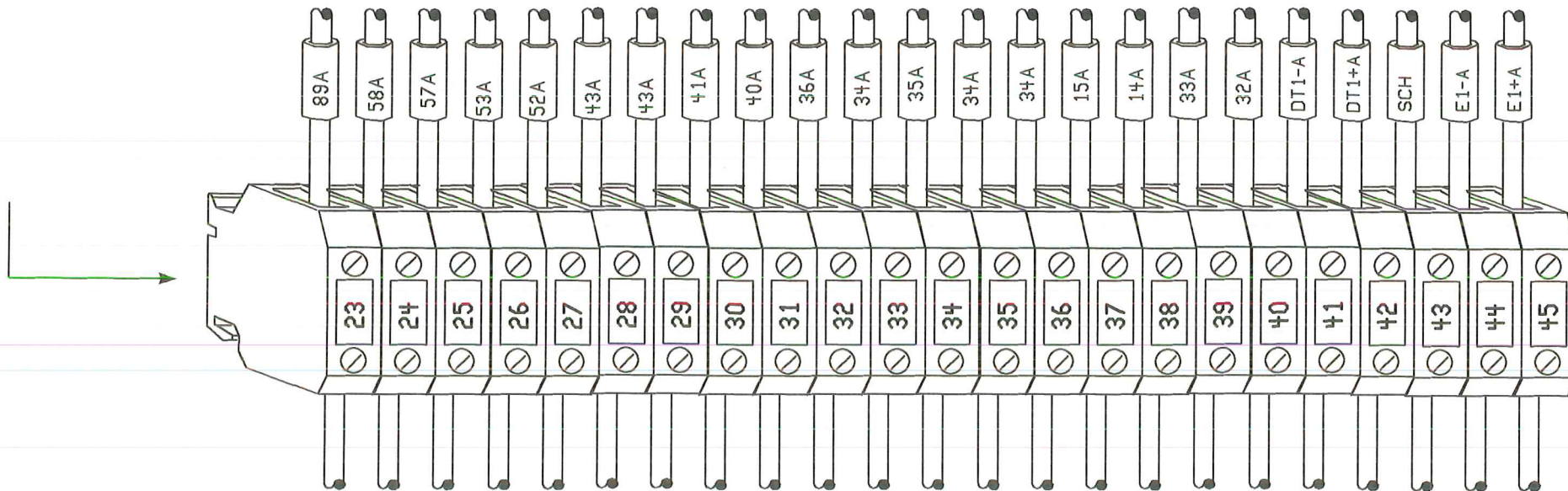
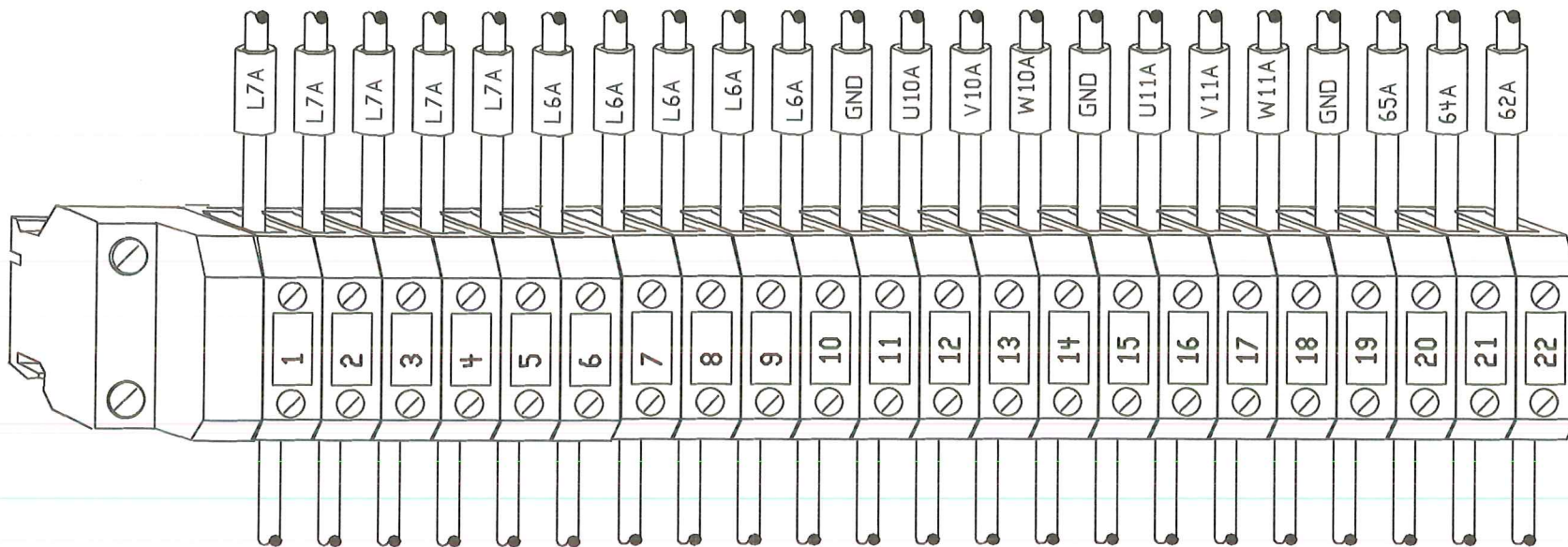

DIS. N.	MACCHINA/DESCRIZIONE: MORSETTIERA			ORDINE: 2001	FOGLIO 27
N. FILE	C.G. SISTEMI s.n.c.	V. G. Cantore N°10	Tel. 0331 733197	Fax. 0331 264077	COMMESSA: 065.A
POS. ARCH.	DATA: 16/05/2001	email. c.g.sistemi@libero.it	CARDANO AL CAMPO (VA) ITALY		ESEGUITO: G.B.
					SEGUE 28

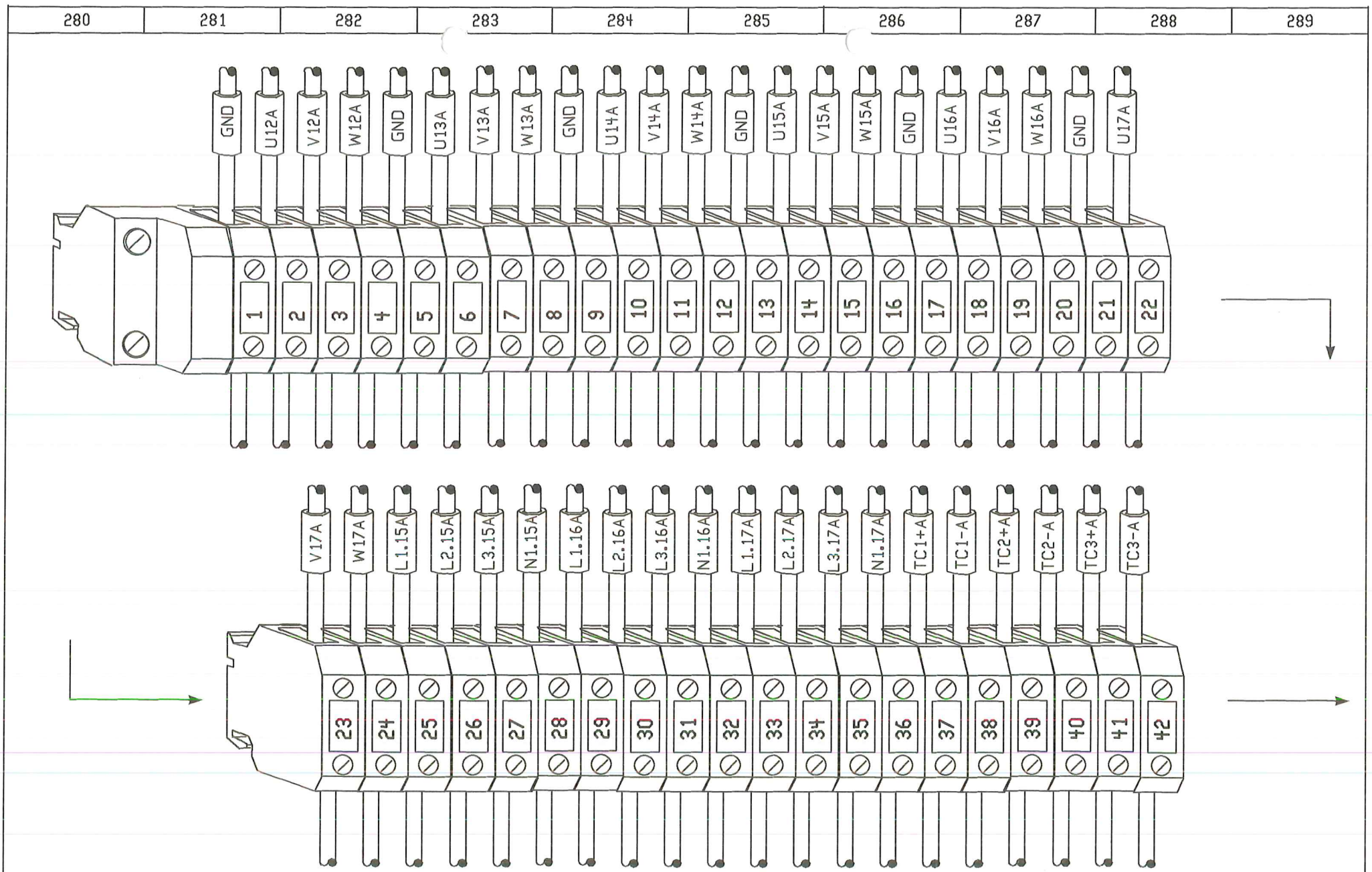

DIS. N.	MACCHINA/DESCRIZIONE: MORSETTIERA			ORDINE: 2001	FOGLIO 28
N. FILE	C.G. SISTEMI s.n.c. V. G. Cantore N°10 Tel. 0331 733197 Fax. 0331 264077			COMMESSA: 065.A	SEGUE 29
POS. ARCH.	DATA: 16/05/2001	email. c.g.sistemi@libero.it	CARDANO AL CAMPO (VA) ITALY	ESEGUITO: G.B.	

290

291

292

293

294

295

296

297

298

299

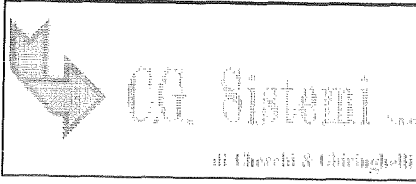
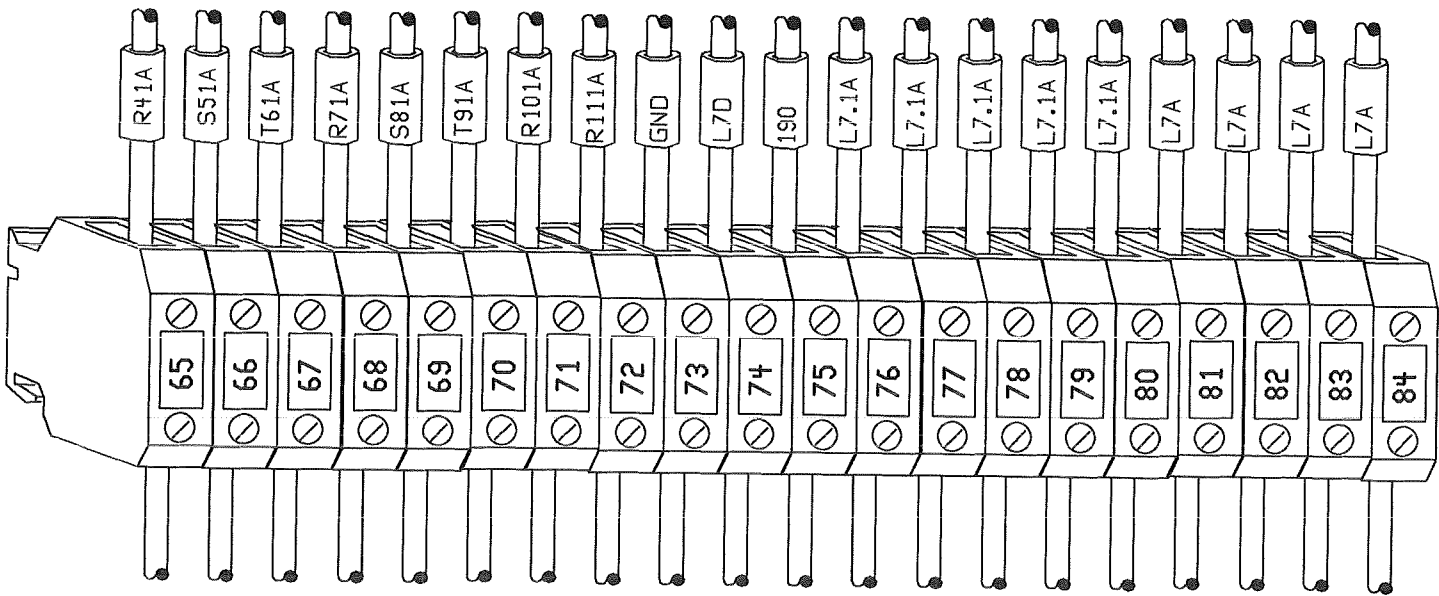
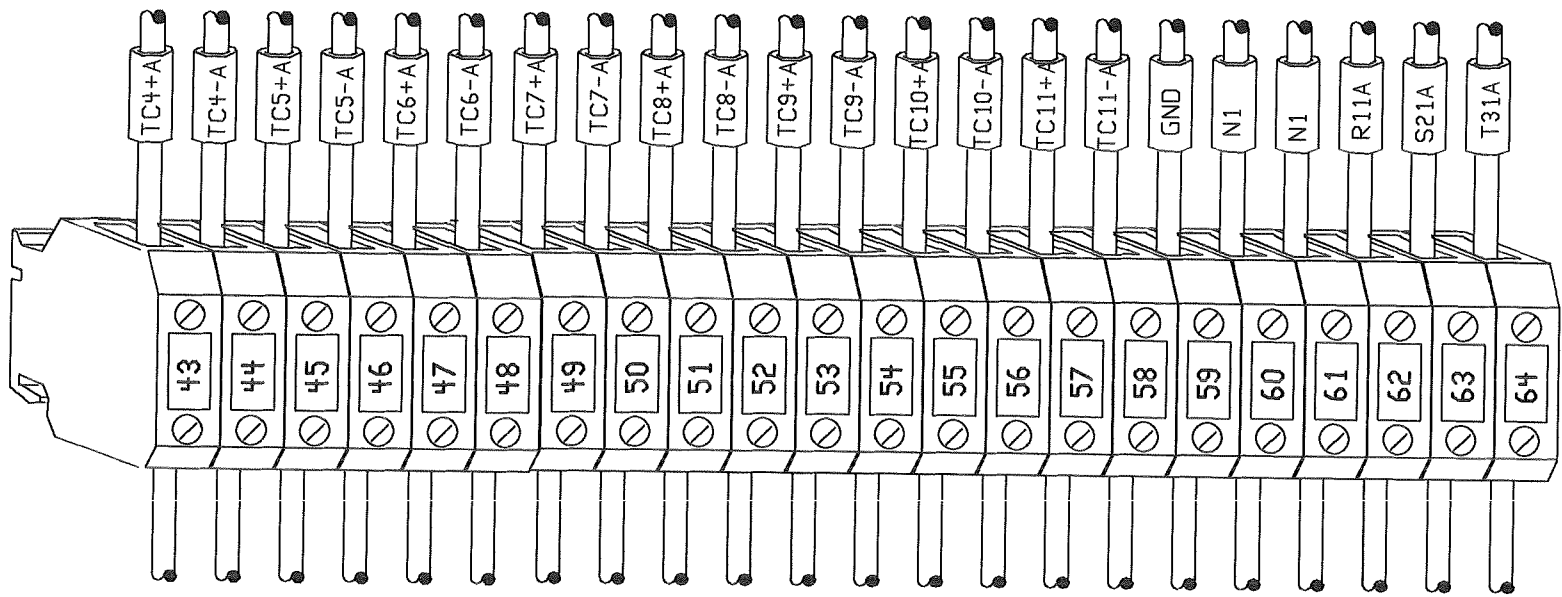

DIS. N.	MACCHINA/DESCRIZIONE: MORSETTIERA			ORDINE: 2001	FOGLIO 29
N. FILE	C.G. SISTEMI s.n.c.	V. G. Cantore N°10	Tel. 0331 733197	COMMESSA: 065.A	SEGUE 30
POS. ARCH.	DATA: 16/05/2001	enail. c.g.sistemi@libero.it	Fax. 0331 264077	ESEGUITO: G.B.	
			CARDANO AL CAMPO (VA) ITALY		

300

301

302

303

304

305

306

307

308

309

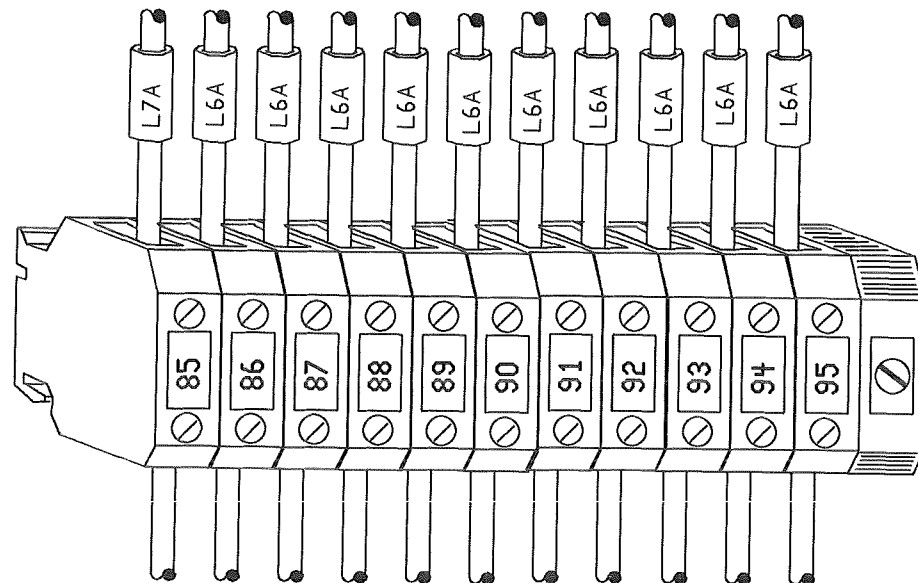

C.G. Sistemi s.p.a.

in Chiavari & Chiavari

DIS. N.	MACCHINA/DESCRIZIONE: MORSETTIERA			ORDINE: 2001	FOGLIO 30
N. FILE	C.G. SISTEMI s.n.c. V. G. Cantore N°10 Tel. 0331 733197 Fax. 0331 264077			COMMESSA: 065.A	
POS. ARCH.	DATA: 16/05/2001	email. c.g.sistemi@libero.it	CARDANO AL CAMPO (VA) ITALY	ESEGUITO: G.B.	SEGUE 31

QFIG	INTERRUTTORE LINEA	TR.	TEREMOREGOLATORE
..QF..	MAGNETOTERMICO AUSILIARI	.TA.	TRASFORMATORE AMPEROMETRICO
FU..	PORTAFUSIBILI	.PA.	INDICATORE AMPEROMETRICO
SF..	FINECORSAINTERNO QUADRO	PT.	PASTIGLIA TERMICA
CV	COMMUTATORE VOLTMETRICO	.U.	SIGLA INVERTER
V	VOLTMETRO PER COMMUTATORE	... Ω	VALORE RESISTENZA
.HLL.	LAMPEGGIANTE DI FASE	.RP.	POTENZIOMETRO
.SQ.	FINECORSA LAMPEGGIANTE DI FASE	.FC.	FINECORSA FUNZIONAMENTO MACCHINA
.SC	SCARICATORE EXTRATENSIONE	R..	NUMERO RESISTENZA DI POTENZA
.A.	ALIMENTATORE STABILIZZATO	ZS..	ZONA STATICA
SB.	SELETTORE 0 -1 INSERZIONE AUSILIARI	TC..	TERMOCOPPIA
EM.	PULSANTE EMERGENZA		
HL.	SPIA FUNZIONAMENTO		
QM.	MAGNETOTERMICO POTENZA		
KM.	TELERUTTORE DI POTENZA		
.M.	MOTORE		
KA.	RELE AUSILIARIO		
.P.	STRUMENTO LETTURA		
.SA.	SELETTORE DI COMANDO		
SB.	PULSANTE DI COMANDO		

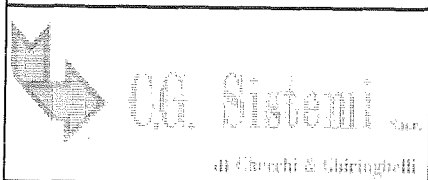

DIS. N.	MACCHINA/DESCRIZIONE: SIGLATURA SIMBOLOGIA USATA			ORDINE: 2001	FOGLIO P
N. FILE	C.G. SISTEMI s.n.c.	V. G. Cantore N°10	Tel. 0331 733197 Fax. 0331 264077	COMMESSA: 065.A	SEGUE Q
POS. ARCH.	DATA: 16/05/2001	email. c.g.sistemi@libero.it	CARDANO AL CAMPO (VA) ITALY	ESEGUITO: G.B.	

A B C D E F G H I L

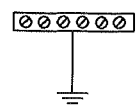

Barra di terra in rame

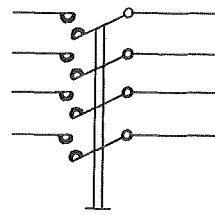

Interruttore gi linea

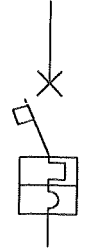

Magnetotermico unipolare

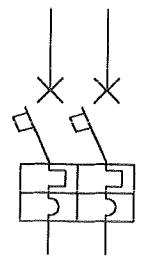

Magnetotermico bipolare

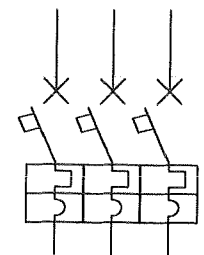

Magnetotermico tripolare

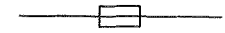

Fusibile a coltello unipolare

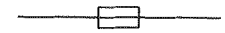

Fusibile a coltello bipolare

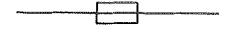

Fusibile a coltello tripolare

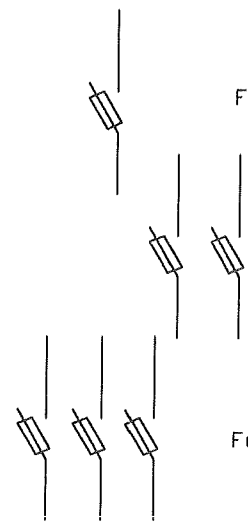

Fusibile a cartuccia unipolare

Fusibile a cartuccia bipolare

Fusibile a cartuccia tripolare

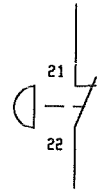

Pulsante fungo emergenza

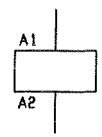

Bobina rele'

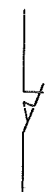

Finecorsa chiuso



Lampada neon

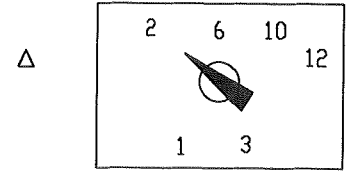

Commutatore voltmetrico

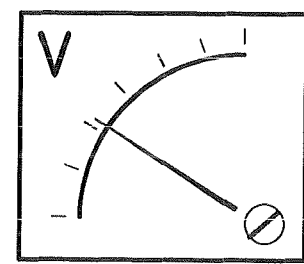

Voltmetro analogico



CG Sistemi
 di Ciarochi & Ghiringhelli

DIS. N.	MACCHINA/DESCRIZIONE: SIMBOLOGIA USATA			ORDINE: 2001	FOGLIO E
N. FILE	C.G. SISTEMI s.n.c.	V. G. Cantore N°10	Tel. 0331 733197	COMMESSA: 065.A	SEGUE F
POS. ARCH.	DATA: 16/05/2001	email. c.g.sistemi@libero.it	CARDANO AL CAMPO (VA) ITALY	ESEGUITO: G.B.	

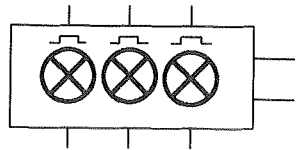

Lampeggiante trifase di linea

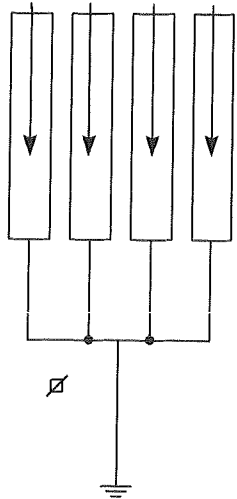

Scaricatore extratensioni



Trasformatore



Motore monofase

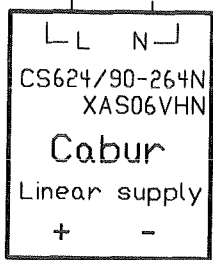

Alimentatore stabilizzato



Selettore aperto 0 - 1



Spia luce fissa

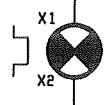

Spia lampeggiante



Massa



Contatto aperto

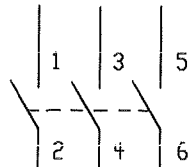

Teleruttore

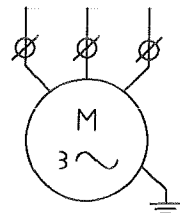

Motore trifase

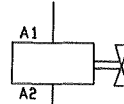

Elettrovalvola

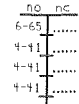

Indice contatti

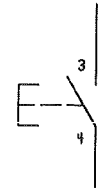

Pulsante aperto

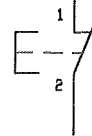

Pulsante chiuso



Morsetto



Pastiglia termica



Selettore chiuso 0 - 1

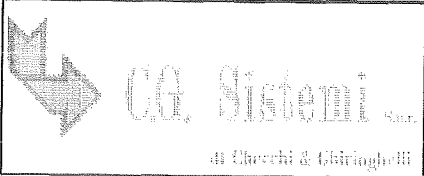

DIS. N.	MACCHINA/DESCRIZIONE: SIMBOLOGIA USATA			ORDINE: 2001	FOGLIO F
N. FILE	C.G. SISTEMI s.n.c.	V. G. Cantore N°10	Tel. 0331 733197	COMMESSA: 065.A	SEGUE G
POS. ARCH.	DATA: 16/05/2001	email. c.g.sistemi@libero.it	Fax. 0331 264077	ESEGUITO: G.B.	
			CARDANO AL CAMPO (VA) ITALY		

A

B

C

D

E

F

G

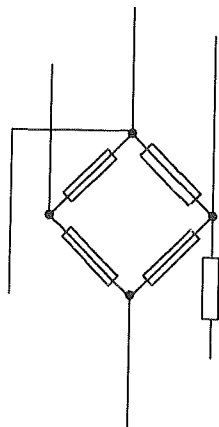

Sonda lettura pressione
tipo strangaugé



Potenziometro

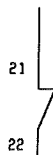

Contatto chiuso

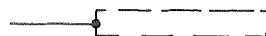

Schermatura

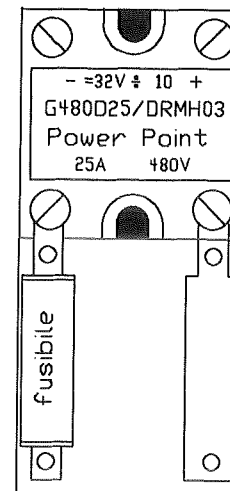

Zona statica

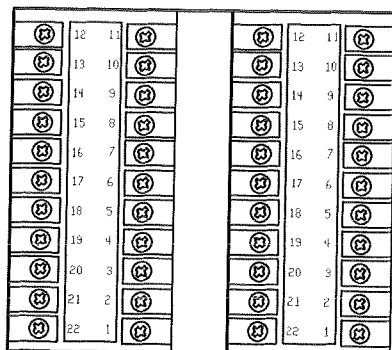

Indicatore di pressione



Resistenza



Finecortsa aperto

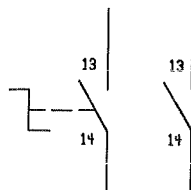

Selettore doppio

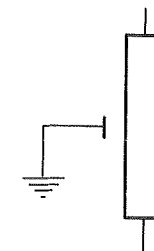

Resistenza di riscaldamento



Strumento analogico

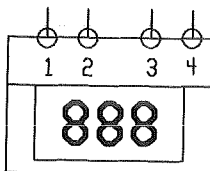

Strumento digitale

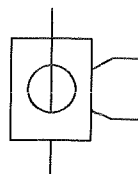

Trasformatore
amperometrico

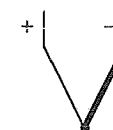

Termocoppia tipo K



CG Sistemi

di Cavotti & Chiappelli

DIS. N.	MACCHINA/DESCRIZIONE: SIMBOLOGIA USATA			ORDINE: 2001	FOGLIO G
N. FILE	C.G. SISTEMI s.n.c. V. G. Cantore N°10 Tel. 0331 733197 Fax. 0331 264077			COMMESSA: 065.A	SEGUE H
POS. ARCH.	DATA: 16/05/2001	email. c.g.sistemi@libero.it	CARDANO AL CAMPO (VA) ITALY	ESEGUITO: G.B.	

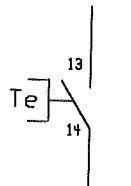

Termostato aperto

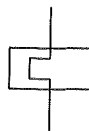

Termica

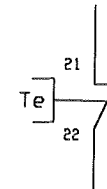

Termostato chiuso



Orologio

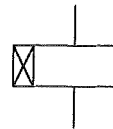
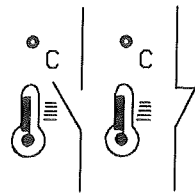

Timer

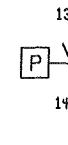

Pressostato chiuso

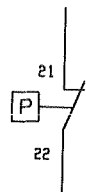

Pressostato chiuso

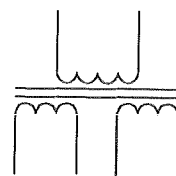

Trasformatore 2 secondari

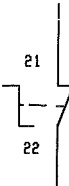

Selettore chiuso

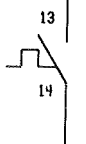

Contatto Termica aperta



Connettore



Timer aperto

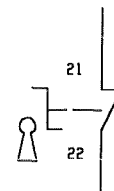

Selettore chiave chiuso

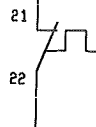

Contatto Termica chiusa

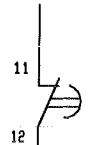

Timer chiuso

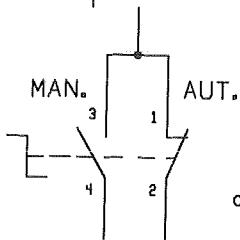

Selettore aperto - chiuso

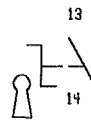

Selettore chiave aperto



CG Sistemi
di Caracci & Chiarugielli

DIS. N.	MACCHINA/DESCRIZIONE: SIMBOLOGIA USATA			ORDINE: 2001	FOGLIO H
N. FILE	C.G. SISTEMI s.n.c.	V. G. Cantore N°10	Tel. 0331 733197	COMMESSA: 065.A	SEGUE I
POS. ARCH.	DATA: 16/05/2001	email. c.g.sistemi@libero.it	CARDANO AL CAMPO (VA) ITALY	ESEGUITO: G.B.	

A

B

C

D

E

F

G

H

I

L

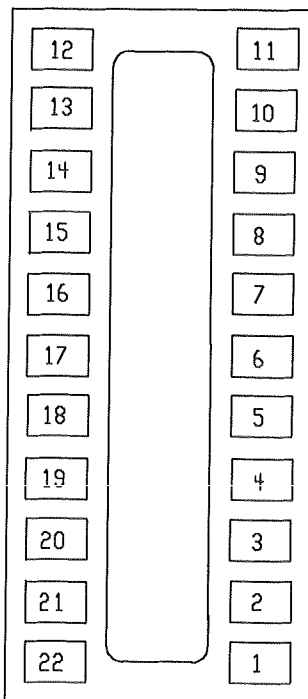

Termoregolatore Gefran

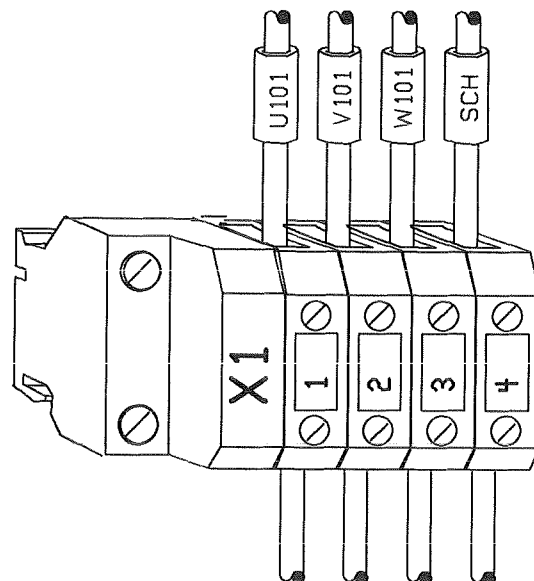

Morsettiera



C.G. Sistemi

di Cerchi & Minghelli

DIS. N.	MACCHINA/DESCRIZIONE: SIMBOLOGIA USATA			ORDINE: 2001	FOGLIO I
N. FILE	C.G. SISTEMI s.n.c.	V. G. Cantore N°10	Tel. 0331 733197	Fax. 0331 264077	COMMESSA: 065.A
PDS. ARCH.	DATA: 16/05/2001	email. c.g.sistemi@libero.it	CARDANO AL CAMPO (VA) ITALY		ESEGUITO: G.B.
					SEGUE L

Pos.	Sigl.	Funzione	Marca	Codice
	FU1	PORTAFUSIBILE BIPOLARE	LEGRAND	10*38 058 28
	FU3	PORTAFUSIBILE TRIPOLARE	LEGRAND	10*38 058 28
	FU4	PORTAFUSIBILE BIPOLARE	LEGRAND	10*38 058 28
	FU5	PORTAFUSIBILE UNIPOLARE	LEGRAND	10*38 058 28
	FU14	PORTAFUSIBILE UNIPOLARE	LEGRAND	10*38 058 28
	FU15	PORTAFUSIBILE UNIPOLARE	LEGRAND	10*38 058 28
	FU16	PORTAFUSIBILE UNIPOLARE	LEGRAND	10*38 058 28
	FU17	PORTAFUSIBILE UNIPOLARE	LEGRAND	10*38 058 28
	FU18	PORTAFUSIBILE UNIPOLARE	LEGRAND	10*38 058 28
	FU8	PORTAFUSIBILE UNIPOLARE	LEGRAND	14*51
	FU9	PORTAFUSIBILE UNIPOLARE	LEGRAND	14*51
	FU10	PORTAFUSIBILE UNIPOLARE	LEGRAND	14*51
	FU11	PORTAFUSIBILE UNIPOLARE	LEGRAND	14*51
	FU12	PORTAFUSIBILE UNIPOLARE	LEGRAND	14*51
	FU13	PORTAFUSIBILE UNIPOLARE	LEGRAND	14*51
		BARRA DISTRIBUZIONE	LEGRAND	
	12TA1	TRASFORMATORE AMPEROMETRICO	IME	60/5A
	13TA1	TRASFORMATORE AMPEROMETRICO	IME	60/5A
	14TA1	TRASFORMATORE AMPEROMETRICO	IME	60/5A
	15TA1	TRASFORMATORE AMPEROMETRICO	IME	60/5A
	16TA1	TRASFORMATORE AMPEROMETRICO	IME	60/5A
	17TA1	TRASFORMATORE AMPEROMETRICO	IME	60/5A
	18TA1	TRASFORMATORE AMPEROMETRICO	IME	60/5A
	19TA1	TRASFORMATORE AMPEROMETRICO	IME	60/5A
	20TA1	TRASFORMATORE AMPEROMETRICO	IME	60/5A
	21TA1	TRASFORMATORE AMPEROMETRICO	IME	60/5A
	22TA1	TRASFORMATORE AMPEROMETRICO	IME	60/5A
	ZS1	ZONA STATICA	POWER POINT	G240D75/DRMH03
	ZS2	ZONA STATICA	POWER POINT	G240D75/DRMH03
	ZS3	ZONA STATICA	POWER POINT	G240D75/DRMH03
	ZS4	ZONA STATICA	POWER POINT	G240D75/DRMH03



DIS. N.	MACCHINA/DESCRIZIONE:	LISTA MATERIALE		ORDINE: 2001	FOGLIO
N. FILE	C.G. SISTEMI s.n.c.	V. G. Cantore N°10	Tel. 0331 733197	COMMESSA:	SEGUE
POS. ARCH.	DATA:	email. c.g.sistemi@libero.it	CARDANO AL CAMPO (VA) ITALY	ESEGUITO: G.B.	

Pos.	Sigl.	Funzione	Marca	Codice
	ZS5	ZONA STATICA	POWER POINT	G240D75/DRMH03
	ZS6	ZONA STATICA	POWER POINT	G240D75/DRMH03
	ZS7	ZONA STATICA	POWER POINT	G240D25/DRMH03
	ZS8	ZONA STATICA	POWER POINT	G240D50/DRMH03
	ZS9	ZONA STATICA	POWER POINT	G240D50/DRMH03
	ZS10	ZONA STATICA	POWER POINT	G240D25/DRMH03
	ZS11	ZONA STATICA	POWER POINT	G240D25/DRMH03
	QM3	MAGNETOTERMICO TRIPOLARE	TELEMECANIQUE	GV2 - M06 1-1,6A
	QM4	MAGNETOTERMICO TRIPOLARE	TELEMECANIQUE	GV2 - M06 1-1,6A
	QM5	MAGNETOTERMICO TRIPOLARE	TELEMECANIQUE	GV2 - M06 1-1,6A
	QM6	MAGNETOTERMICO TRIPOLARE	TELEMECANIQUE	GV2 - M06 1-1,6A
	QM7	MAGNETOTERMICO TRIPOLARE	TELEMECANIQUE	GV2 - M06 1-1,6A
	QM8	MAGNETOTERMICO TRIPOLARE	TELEMECANIQUE	GV2 - M06 1-1,6A
	QM1	MAGNETOTERMICO TRIPOLARE	TELEMECANIQUE	GV2 - M07 1,6-2,5A
	QM2	MAGNETOTERMICO TRIPOLARE	TELEMECANIQUE	GV2 - M08 2,5-4A
	QF1	MAGNETOTERMICO BIPOLARE	MERLIN GERIN	24296
	QF2	MAGNETOTERMICO BIPOLARE	MERLIN GERIN	24296
	QF3	MAGNETOTERMICO BIPOLARE	MERLIN GERIN	24296
	K3M	TELERUTTORE	TELEMECANIQUE	LC1 D09
	K4M	TELERUTTORE	TELEMECANIQUE	LC1 D09
	K5M	TELERUTTORE	TELEMECANIQUE	LC1 D09
	K6M	TELERUTTORE	TELEMECANIQUE	LC1 D09
	K7M	TELERUTTORE	TELEMECANIQUE	LC1 D09
	K8M	TELERUTTORE	TELEMECANIQUE	LC1 D09
	K1M	TELERUTTORE	TELEMECANIQUE	LC1 D09
	K2M	TELERUTTORE	TELEMECANIQUE	LC1 D09
	KA1	TELERUTTORE	TELEMECANIQUE	LC1 D09
	KA4A	RELE' + ZOCCOLO	OMRON	MY4
	KA5A	RELE' + ZOCCOLO	OMRON	MY4
	KA6A	RELE' + ZOCCOLO	OMRON	MY4
	KA2A	RELE' + ZOCCOLO	OMRON	MY4

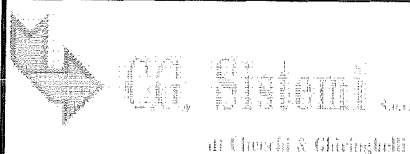

DIS. N.	MACCHINA/DESCRIZIONE: LISTA MATERIALE			ORDINE: 2001	FOGLIO
N. FILE	C.G. SISTEMI S.p.A.	V. G. Cantore N°10	Tel. 0331 733197	COMMESSA:	SEGUE
POS. ARCH.	DATA:	email. c.g.sistemi@libero.it	Fax. 0331 264077	ESEGUITO: G.B.	
			CARDANO AL CAMPO (VA) ITALY		

Pos.	Sigl.	Funzione	Marca	Codice
	TR1	TRASFORMATORE	MARTIGNONI	0-400/55-0-55V 100VA
	IG1	INTERRUTTORE	MERLIN GERIN	C801N 800A
	FU2	PORTAFUSIBILE BIPOLARE	LEGRAND	10*38 058 28
	G1	SCHEDA CONTREX	CONTREX	
	G2	SCHEDA CONTREX	CONTREX	
	G3	RITARDATORE BOBINA	MERLIN GERIN	G PKZM 0
	U1	INVERTER	EUROTHERM DRIVES	590 ANALOG
	K11M	TELERUTTORE	TELEMECANIQUE	LC1 F500
	FU6	PORTAFUSIBILI TRIPOLARE + FUSIBILI	EAN MULLER	WDE 0636/23 630A
	L1	INDUTTANZA	ELTRA	LR3 605/910 0.05
	TR1	TERMOREGOLATORE	DIGITEK MP7	TPL 3
	TR2	TERMOREGOLATORE	DIGITEK MP7	TPL 3
	TR3	TERMOREGOLATORE	DIGITEK MP7	TPL 3
	TR4	TERMOREGOLATORE	DIGITEK MP7	TPL 3
	TR5	TERMOREGOLATORE	DIGITEK MP7	TPL 3
	TR6	TERMOREGOLATORE	DIGITEK MP7	TPL 3
	TR7	TERMOREGOLATORE	DIGITEK MP7	TPL 3
	TR8	TERMOREGOLATORE	DIGITEK MP7	TPL 3
	TR9	TERMOREGOLATORE	DIGITEK MP7	TPL 3
	TR10	TERMOREGOLATORE	DIGITEK MP7	TPL 3
	TR11	TERMOREGOLATORE	DIGITEK MP7	TPL 3
	12PA1	AMPEROMETRO	IME	60/5A
	13PA1	AMPEROMETRO	IME	60/5A
	14PA1	AMPEROMETRO	IME	60/5A
	15PA1	AMPEROMETRO	IME	60/5A
	16PA1	AMPEROMETRO	IME	60/5A
	17PA1	AMPEROMETRO	IME	60/5A
	18PA1	AMPEROMETRO	IME	10/5A
	21PA1	AMPEROMETRO	IME	10/5A
	22PA1	AMPEROMETRO	IME	10/5A
	19PA1	AMPEROMETRO	IME	30/5A

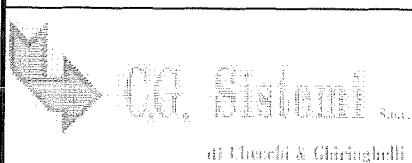

DIS. N.

MACCHINA/DESCRIZIONE:

LISTA MATERIALE

ORDINE: 2001

FOGLIO

N. FILE

C.G. SISTEMI

S.p.A.

V. G. Cantore N°10

Tel. 0331 733197

Fax. 0331 264077

COMMESSA:

POS. ARCH.

DATA:

email. c.g.sistemi@libero.it

CARDANO AL CAMPO (VA) ITALY

ESEGUITO: G.B.

SEGUE

Pos.	Sigl.	Funzione	Marca	Codice
	20PA1	AMPEROMETRO	IME	30/5A
	12SA1	SELETTORE 0/1	TELEMECANIQUE	XB4 - BD21
	13SA1	SELETTORE 0/1	TELEMECANIQUE	XB4 - BD21
	14SA1	SELETTORE 0/1	TELEMECANIQUE	XB4 - BD21
	15SA1	SELETTORE 0/1	TELEMECANIQUE	XB4 - BD21
	16SA1	SELETTORE 0/1	TELEMECANIQUE	XB4 - BD21
	17SA1	SELETTORE 0/1	TELEMECANIQUE	XB4 - BD21
	18SA1	SELETTORE 0/1	TELEMECANIQUE	XB4 - BD21
	19SA1	SELETTORE 0/1	TELEMECANIQUE	XB4 - BD21
	20SA1	SELETTORE 0/1	TELEMECANIQUE	XB4 - BD21
	21SA1	SELETTORE 0/1	TELEMECANIQUE	XB4 - BD21
	22SA1	SELETTORE 0/1	TELEMECANIQUE	XB4 - BD21
	V1	VOLTMETRO	F.C.MISURE	EQ 96 E
	CV	COMMUTATORE VOLTMETRICO	BREMAS	EM 60947 3
	HR1	OROLOGIO	VEMER	VE 7976
	T1	TEMPORIZZATORE	OMRON	H30S - SL
	EM0	PULSANTE EMERGENZA	TELEMECANIQUE	XB4 - BS542
	EM1	PULSANTE EMERGENZA	TELEMECANIQUE	XB4 - BS542
	2SA1	SELETTORE LUMINOSO	TELEMECANIQUE	XB4 - BK123B5
	HL3			
	S1	SELETTORE A CHIAVE	TELEMECANIQUE	XB4 - BG21
	HL1	SPIA VERDE	TELEMECANIQUE	XB4 - BVG3
	HL2	SPIA BIANCA	TELEMECANIQUE	XB4 - BVG1
	HL5	SPIA ROSSA	TELEMECANIQUE	XB4 - BVG4
	HL6	SPIA ROSSA	TELEMECANIQUE	XB4 - BVG4
	HL7	SPIA ROSSA	TELEMECANIQUE	XB4 - BVG4
	EV1	VENTOLA QUADRO	FANDIS	
	EV2	VENTOLA QUADRO	FANDIS	
	HLL1	LAMPEGGIANTE PRESENZA TENSIONE	CEMA	
	HLL2	LAMPEGGIANTE PRESENZA TENSIONE	CEMA	

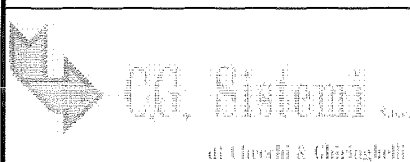

DIS. N.	MACCHINA/DESCRIZIONE:	LISTA MATERIALE	ORDINE: 2001	FOGLIO
N. FILE	C.G. SISTEMI S.n.C.	V. G. Cantore N°10	COMMESSA:	
POS. ARCH.	DATA:	email. c.g.sistemi@libero.it	ESEGUITO: G.B.	SEGUE
		Tel. 0331 733197 Fax. 0331 264077		
		CARDANO AL CAMPO (VA) ITALY		